

Board of Regents University System of Georgia

Facilities Management /Design & Construction

Georgia Tech Yellow Book

Design Standards



Issued: October 30, 2019

(Solid vertical lines in the margins within the body of the text indicate a revision to the previous edition of the GT-Yellow Book.)

To quickly jump to a desired section, place your pointer on the Table of Contents page section title and pick/select. Use link at the bottom of the page to return to the Table of Contents.



Table of Contents

- 000001 – Revised Sections
- 010001 - General Requirements
- 013329 - Sustainable Design Reporting
- 013546 - Indoor Air Quality (IAQ) Scheduling / Sequencing Requirements
- 015713 - Temporary Erosion and Sediment Control-(section **deleted** / now included in 312500)
- 015721 - Indoor Air Quality (IAQ) Design and Performance Requirements
- 017419 - Construction Waste Management and Disposal
- 017801 - Commissioning Closeout Procedures
- 017900 - Demonstration and Training
- 018113 - Sustainable Design Requirements
- 018800 - Other Requirements
- 019100 - Commissioning General Requirements
- 022100 - Surveys
- 030000 - Concrete
- 040000 - Masonry
- 050000 - Metals
- 061000 - Rough Carpentry
- 064000 - Architectural Woodwork
- 071000 - Dampproofing and Waterproofing
- 072100 - Thermal Insulation
- 072700 - Firestopping
- 075000 - Membrane Roofing & Flashing
- 081000 - Doors
- 085000 - Windows
- 087000 - Door Hardware
- 092000 - Gypsum Board Assemblies
- 094000 - Ceilings
- 096000 - Flooring
- 096900 - Access Flooring
- 099000 - Paints and Coatings
- 101100 - Visual Display Boards
- 102113 - Toilet Partitions
- 102116 - Shower and Dressing Compartments
- 102813 - Toilet Accessories
- 104100 - Interior Signage

122413 - Roller Shades
123000 - Laboratory Casework
124800 - Rugs and Mats
129313 - Bicycle Racks
142000 - Elevators
221116 - Plumbing Piping
224000 - Plumbing Fixtures
224700 - Drinking Fountains and Water Coolers
230001 - Mechanical - General and Design
230002 - HVAC- General and Design
230003 - Space Conditions
230004 - Design Criteria
230519 - Metering and Related Piping
230900 - DDC Controls and HVAC Instrumentation
230901 - Compressed Air Piping Systems
231112 - Campus Chilled Water Distribution
231113 - Hydronic Piping
232123 - Hydronic Pumps
232213 - Steam & Condensate Heating Piping
234100 - Air Treatment Equipment – Filters
236416 - Centrifugal and Rotary Screw Water Chillers
236500 - Cooling Towers
237200 - Ventilation Systems
237201 - Laboratory Fume Hoods
237205 - Building-Specific Laboratory Controls Requirements -Ford ES&T (147) And U.A. Whitaker (165) Buildings
237313 - Indoor Central-Station Air-Handling Units
238123 - Computer Room Air Conditioning Units
238233 - Heating Systems
238234 - EPA Title V Requirements
260000 - Electrical General
260513 - Medium-Voltage Cable
260519 – 600V Conductors
260526 - Grounding and Bonding
260533 - Raceways and Boxes

260543 - Underground Ductbanks, Manholes and Vaults
260553 - Identification
260573 – Power System Studies
260923 - Lighting Controls
261000 - Campus Medium Voltage Electrical Distribution
261212 - Liquid-Filled Network Transformers
261219 - Pad-Mounted Liquid-Filled Transformers
261328 - Medium Voltage Loop Switches
261329 - Medium Voltage Fault Interrupter Switches
262200 - Low-Voltage Transformers
262300 - Low-Voltage Switchgear
262316 - Network Protectors
262413 - Switchboards
262416 - Panel boards
262419 - Motor Control Centers
262500 - Enclosed Bus Assemblies
262713 - Electricity Metering
262726 - Wiring Devices
262816 - Enclosed Circuit breakers and Switches
262913 - Enclosed Controllers
262923 - Variable Frequency Drives
263213 - Packaged Engine Generators
263600 - Automatic Transfer Switches
265100 - Interior Lighting
265600 - Exterior Lighting
270500 - Common Work Results for Communications
273013 - Emergency Phones
274100 - Multimedia Infrastructure
274110 - Distance Learning
275313 - Clock Systems
281300 - Access Control
282300 - Video Surveillance
283100 - Fire Detection and Alarm
283300 - Fuel-Dangerous-Gas Detection and Alarm
310000 - Earthwork

312500 - Erosion and Sedimentation Controls

320000 - Exterior Improvements

321000 - Bases and Paving

323100 - Fences and Gates

323200 - Retaining Walls

331000 - Water Utilities

333000 – Sanitary Sewerage Utilities

334000 - Storm Drainage Utilities

339000 - Cisterns

The following sections have been revised in this issue:

010001 General Requirements

0157713 Temporary Erosion and Sedimentation Controls (Section deleted)

123000 Laboratory Casework

230900 DDC Controls and HVAC Instrumentation

237205 Building-Specific Laboratory Controls Requirements -Ford ES&T (147) And U.A.
Whitaker (165) Buildings- **New Section**

312500 Erosion and Sedimentation Controls

010001- GENERAL REQUIREMENTS

1.00 General Requirements

- A. These standards are for the guidance of Architects, Engineers, and contractor in the technical design of new buildings, additions to buildings and building renovations. They are minimum standards. Actual design should be consistent with the overall program, building quality, and scope of project. The design should be in context with, and in harmony with, the existing buildings on campus with sensitivity to the surrounding pallet of materials and colors.
- B. Components accepted for installation must be current production model or running line that will allow for the expeditious reorder of parts or materials. Avoid the acceptance or installation of unique, special order components without local vendor representation which would make it difficult (and in some cases impossible) to obtain replacement parts or materials. Products offered as a donation must abide by this criteria.
- C. All new buildings and major renovations planned at Georgia Tech shall have an energy analysis performed to assure compliance with the Georgia State Code for Energy Conservation in New Buildings and the Energy Efficiency and Sustainable Construction Act of 2008.
- D. If the Architect and/or the Engineer desire to make any exceptions to the Design Standards, written approval from the Office of Facilities must be obtained. Electronic mail communication to request the exceptions is acceptable.
- E. Project time constraints, building size and complexity, and other factors may require the addition of a Management Scheduling Consultant to the Construction Team. This consultant will be retained by Georgia Tech Office of Facilities. In their contracts, the Architect and General Contractor should include time for coordination meetings with this consultant. See Section 01311 for details.
- F. Consultants responsible for underground utility systems design shall be experienced in three- dimensional coordinated design of utility systems similar to those required by the project and shall be experienced in producing plan and profile drawings for utility construction.

2.00 Authorities and Code Regulations

- A. Board of Regents of the University System of Georgia
- B. Vice Chancellor, Office of Facilities
- C. Office of Facilities Guidelines for Preplanning Manual
http://www.usg.edu/building_project_procedures/chapter6/App6A.phtml
- D. Office of Facilities Building Project Procedure Manual 2000
https://www.usg.edu/building_project_procedures/
- E. Facilities IT Guidelines
https://www.usg.edu/assets/facilities/documents/facilities_it_guidelines.pdf
- F. Historic Preservation Plan Guideline
https://www.usg.edu/assets/facilities/documents/campus_historic_preservation.pdf

- G. Georgia Institute of Technology Office of Facilities
 - 1. GT Facilities Director Design and Construction
 - 2. Board of Regents Contract Documents
- H. Campus Landscape Standards
 - 1. See website: www.space.gatech.edu/landscape-master-plan
 - 2. (Acrobat Reader program required to open the file.)
- I. Architectural and Engineering Design Standards for Building Technology (the “Yellow Book”)
 - 1. See website <http://www.facilities.gatech.edu/standards-forms>
(Acrobat reader program required to open the file)
- J. GT BIM Requirements, Execution Plan, Component Check List, and Revit Template:
 - 1. See website <http://www.facilities.gatech.edu/standards-forms>
(Acrobat reader program required to open the file)
- K. Presentation Standards:
 - 1. See website: <http://www.facilities.gatech.edu/standards-forms>
- L. Board of Regents State Construction Manual
 - https://www.usg.edu/building_project_procedures/
- M. Georgia State Finance and Investment Commission
 - 1. State Construction Manual: <https://qsfc.georgia.gov/state-construction-manual>
 - 2. Georgia Department of Community Affairs
www.dca.state.ga.us/development/constructioncodes/
 - a. International Building Code, last adopted Edition (with current Georgia amendments)
 - b. International Plumbing Code, last adopted Edition (with current Georgia amendments)
 - c. International Mechanical Code, last adopted Edition (with current Georgia amendments)
 - d. National Electric Code, last adopted Edition (with current Georgia amendments)
 - e. ANSI 17.1 Elevator Code as adopted by State of Georgia
 - f. Energy Efficiency and Sustainable Construction Standards for State Buildings

N. Accessibility Requirements

1. ADA Title II. Comply with 2010 ADA Standards for Accessible Design. Comply with Fair Housing Accessibility Guidelines.
2. Georgia Accessibility Code See website:
<https://ada.georgia.gov/georgia-accessibility-code>
3. Georgia Environmental Policy Act
http://georgiashpo.org/laws_GeorgiaEnvironmentalPolicyAct
4. Georgia Elevator Law/Elevator Rules and Regulations as enforced by the Department of Labor
<https://www.oci.ga.gov/Externalresources/Documents/FireMarshal%20-%20Rules%20and%20Regulations/120-3-25%20Escalators%20and%20Elevators.pdf>
5. Georgia Historic Stewardship Program, State Historic Preservation Division.
http://georgiashpo.org/state_stewardship

O. State of Georgia Fire Marshal

1. NFPA 101 - Life Safety Code, last adopted Edition (with current Georgia amendments).
2. Contract Documents are to be submitted by the Georgia Tech Project Manager to the Campus Fire Marshal and the State Fire Marshal's Office if required based on the funding source, ownership and new building status for review and approval. The Campus Fire Marshal or the State Fire Marshal will issue the Building Permit and authorize the Certificate of Occupancy.
3. The Campus Fire Marshal may also be of assistance in scheduling with the State Fire Marshal's Office for Contract Document review.
4. Contract Documents for independently owned Fraternity or Sorority houses to be constructed on land leased from the Board of Regents / State of Georgia must be reviewed and approved by the State Fire Marshall who will issue the Building Permit and Certificate of Occupancy. A certified inspection service must be hired to inspect and approve the work of all construction trades to have utility connections for permanent service.

P. Fulton County Health Department

1. Permits for Food Service Facilities & Swimming Pools.

Q. City of Atlanta

1. The Georgia State Department of Natural Resources Environmental Protection Department has authorized the City of Atlanta to regulate and conduct technical reviews of projects with soil disturbances requiring erosion control. This review is administered by site plan review officers of the Highways and Streets Department. A Soil Disturbance Permit will be required, and a fee may be charged.
2. City of Atlanta Building Code Sec. 8-2074, includes the Georgia Tech Campus within the City Fire Limits. All construction within the City Fire Limits must be non-combustible. Therefore, no wood framing is permitted. Exceptions may be submitted for variance and approval to the State Fire Marshal.

3. The Department of Watershed Management has responsibility for water and storm/sewer taps, water taps and fire hydrants.
4. Any contact with the City of Atlanta regarding utilities coordination is to be cleared beforehand with the Georgia Tech Office of Facilities.
5. Preliminary plans and elevations of Fraternity or Sorority houses to be constructed on privately owned land must be reviewed and approved by the Georgia Tech Office of Facilities. Building Permits will be issued and inspections will be executed by the City of Atlanta for privately owned land.

R. Atlanta Gas Light

1. Coordinate gas utilities through the Utilities Manager, Georgia Tech Office of Facilities. The Office of Facilities and the Campus Fire Marshall must inspect gas piping installations.

3.00 BIM Standards

A. General

1. Building Information Modeling (BIM) Requirements
<https://facilities.gatech.edu/standards-forms>
2. Building Information Modeling (BIM) GT COBIE
<https://facilities.gatech.edu/standards-forms>
3. Building Information Modeling (BIM) Execution Plan Template
<https://facilities.gatech.edu/standards-forms>

4.00 Drawing Standards

- A. Each set of drawings shall satisfy the following minimum requirements:
1. Provide a key map and key plans to show the location of the work site.
 2. Provide sufficient information to enable the contractor to determine from the drawings alone the total quantities of all materials and equipment required to execute the work.
 3. Locate all equipment, piping, and ductwork accurately and free of interference with all other building components.
 4. Present plans of all trades with the same orientation.
 5. Present all information in any orderly manner, legible, and consistent with the highest professional standards.
 6. Provide plans for International Building Code and Life Safety Code approval. Plans will clearly show exit paths and the measured distances to exits, exit capacities and all fire rated wall conditions.
 7. Have imprinted on each sheet the registration seal and legal signature of the registered professional architect or engineer who is responsible for designs.

- B. Drawing Medium:
1. Plot all drawings to the same sheet size for all trades.
 2. The Project title and record date will be the same on all sheets.
 3. All new buildings and major renovations shall be in Revit BIM model.
 4. Each trade to be a separate model linked/ing to the respective trades for the design.
 5. Upon final submittal each file shall be stand-alone files and shall not be collaborative files.
 6. Each Family element shall have the CSI specification referenced, basis of design manufacture, size and model number.
 7. Drawings to be numbered per the Uniform Drawing System - Drawing Set Organization as published in the United States National Cad Standards Manual.
- C. Line Work:
1. Line widths shall be graded for identification purposes from very thin (hatching patterns) to wide (elements cut in horizontal or vertical sections) using a consistent pattern.
- D. Lettering:
1. Lettering, as printed, shall not be smaller than 1/8" in height (12" for 1/8" scale, 6" for 1/4" scale, 3" for 2"scale, etc.).
- E. Scales:
1. Floor plans shall be drawn at not less 1/8" = 1' - 0" (unless used as key plans). Enlarged detail plans (bathrooms, mechanical rooms, etc.) at not less than 1/4" = 1' - 0", preferably at 1/2"= 1' - 0".
 2. Indicate the scale used under each drawing or note as not to scale.
- F. Symbols and Abbreviations:
1. Provide a legend of symbols and abbreviations used for each discipline.
- G. Site Plan:
1. Show all outside piping and mechanical equipment on the architectural site plan. If necessary, repeat this information on separate engineering site plans for clarity.
 2. Show underground utilities in plan and profile. See individual sections for additional requirements for each type of utility. Plan and profile drawings shall be provided for the following as a minimum:
 - a. Gravity drainage systems
 - b. Pressure systems with pipe sizes exceeding 3", except for steam and condensate.
 - c. All steam and condensate piping.
 - d. All medium voltage electric duct banks.

- e. All concrete encased communications ductbanks containing one or more 4” conduits or containing more than (2) 2” conduits.
- H. Floor Plans:
1. All rooms and spaces to be numbered per the Georgia Tech Room Numbering Guidelines. Plan the Room Numbering to be consistent with a graphical wayfinding scheme that must be developed and approved at schematic design. See website www.space.gatech.edu
 2. Show all fixtures and equipment on the plans.
 3. All rooms and spaces to be numbered per the Georgia Tech Room Numbering Guidelines. See website www.space.gatech.edu/aboutus.htm (Acrobat Reader program required to open this file).
 4. On the Reflected Ceiling Plan show all light fixtures, including exit signs and emergency lights, HVAC supply and return grilles, sprinkler heads, and audio and video equipment.
 5. Provide separate Furniture Plans as needed.
- I. Roof Plan:
1. Show all equipment, piping, and any ductwork located on roof. Show all roof penetrations and provide appropriate details of each type condition. Use standard details of the National Roofing Contractors Association (N.R.C.A.) and SMACNA.
- J. Building Sections:
1. Indicate all building components including ductwork and piping.
 2. In spaces such as ceiling spaces above hallways or any other space where HVAC ductwork or piping is located, show the location and elevation of each trade’s work.
- K. Isometrics, Schematic Diagrams, Typical and Special Details:
1. Use to clarify plan and section views.

5.00 Required Deliverables by Phase

- A. **Concept Design** deliverables must be appropriate to the project scope for a new building, substantial addition or major renovation and include, at a minimum, the following:
1. Site plans
 2. Floor plans
 3. Elevations
 4. Cost information
 5. Preliminary scheme evaluations
 6. Energy Budget – Establish Energy Intensity (EUI) goals as well as goals for exceeding energy code minimums as a percent. Provide energy budgets for GT utilities to include: Chilled water, steam, GT gas, electrical and renewables. All energy goals and budgets shall be incorporated into the Owner.

- B. **Schematic Design** deliverables must be appropriate to the project scope for a new building, substantial addition or major renovation and include, at a minimum, the following:
1. Site drawings – Show adjacent buildings, existing and proposed elevation contours, existing and new site utilities, vehicular and pedestrian flow, parking, service access and special construction required.
 2. Floor plans – Indicate proposed structural bays with room layouts that include door swings, program room numbers, names, areas and furniture. Identify mechanical, electrical and equipment rooms with fire walls, stairs and elevators. Show roof plans and proposed screen and parapet walls. Partial plans will include key plans.
 3. Fire Resistance Floor Plans – Illustrate all fire walls and means of egress for all phases of construction. Each phase of construction will comply with life safety and means of egress during the construction period. The Drawings must illustrate temporary measures for means of egress during any sequence or phase of construction.
 4. Elevations – Develop all elevations and exterior canopies. Define anticipated grade, floor and bearing elevations.
 5. Building Sections – Develop a section through the entire building illustrating relationships of architectural and structural features and elements. Show all anticipated floor, ceiling, roof and exterior grade elevations.
 6. Equipment and Furniture – Illustrate furniture and equipment defined in the Program.
 7. Massing studies – Study models and computer generated graphics of the building, illustrating mass relationships and entrances of the facility.
 8. Geotechnical and survey drawings – Services acquired, and reports received which justify and support the final location of the construction, which is established in this stage.
 9. Specifications- An outline specification indicating materials, types of construction, proposed mechanical systems, plumbing systems, fire protection, security systems and proposed electrical and life cycle analysis investigations.
 10. A Statement of Probable Construction Cost. Construction cost estimates will be within available budget constraints and will give appropriate mention of and respect for seasonal construction constraints. Scope change elements in the design process or current state of design affecting the original budget requirements will be identified and defined.
 11. Energy Model/Energy Budget – Provide and updated EnergyPlus model and outputs with project assumptions. Document EUI output from the energy model and comparison of the energy model to the current energy code as a percent to validate goals set in Concept Design. EUI shall be broken into Equipment/Plug load, Lighting, HVAC and renewables. Utility budgets for GT gas, steam, chilled water and power shall also be updated. Changes to goals must be approved by the Director of Facilities/D&C and updated in the OPR as needed.

- C. **Design Development** deliverables must be appropriate to the project scope for a new building or substantial addition or major renovation and include, at a minimum, the following:
1. Architectural & Civil
 - a. Site Layout and Materials Plan – Illustrate the design forms and materials to be used. Major dimensions will be indicated. All appearance-related design issues should be addressed, resolved and shown.
 - b. Site Grading and Drainage Plan – Show developed drainage concepts, include existing and new contours, drainage structures (numbered for general reference), and spot grade elevations.
 - c. Site Utilities Plan – Indicate the plan relationships of existing and proposed utilities. Vertical relationship of the utilities will be noted by plan notations and profiles. Site plan including grading and site utilities, utility connection points and a stormwater management design.
 - d. Planting Plan – Illustrate the centerpoints at desired spacing of major plantings. A key will explain the proposed form and design characteristics of the plants (large shade tree, flowering ornamental tree, low evergreen shrub, etc.). Existing trees to remain, and proposed trees will be indicated.
 - e. Design Details – Show the design or detailing to be used in the site development. These details will clarify the relationship of vertical and horizontal surfaces, steps, walls and pavements, etc., including edge conditions at adjacent surfaces.
 - f. Dimensioned floor plans indicating structural bay sizes and overall building dimensions. Floor Plan should show dimensions of major elements, and final partition locations, including all openings.
 - g. Exterior and interior wall sections showing final dimensional relationships, material and component relationships.
 - h. Floor Plan showing all fixed and loose equipment
 - i. Large scale plans and sections as needed.
 - j. Room finish schedule identifying all finishes, or Finish Plans.
 - k. Building sections
 - l. Door and hardware schedule showing door, frame and hardware type, and fire ratings, if any
 - m. Window schedule showing types and sizes
 - n. Preliminary development of details
 - o. Reflected ceiling plan including ceiling grid, light fixtures and all devices that penetrate or are mounted upon finished ceiling
 - p. Interior movable furniture, office equipment, demountable partitions and system furniture, layouts for all departments and floors including proposed building signage system
 - q. A thorough outline technical specification including all proposed materials.

2. Structural
 - a. Foundation drawings
 - b. Floor plan with all structural members located and sized
 - c. Footing, beam, column and connection schedules
 - d. Final floor elevations
3. Plumbing & Mechanical
 - a. Mechanical equipment schedule indicating size and capacity
 - b. Plumbing Fixtures Schedule
 - c. Floor plans indicating mechanical equipment and plumbing fixtures. All equipment and fixtures should be shown and located.
 - d. Floor plans showing main ductwork distribution, branch ductwork and plumbing piping. All ductwork and piping should be located and sized to coordinate with structural framing system
 - e. All ceiling mounted devices should be located
 - f. Legend showing all symbols used on drawings
4. Electrical
 - a. Floor plan showing all major electrical equipment (switchgear, distribution panels, emergency generator, transfer switches, UPS system, etc.) which will be dimensioned and drawn to scale
 - a. Site plan showing preliminary site lighting design with pole and fixture type designations
 - b. Floor plan showing lighting layout, power, telecommunications and office automation devices and switches with preliminary circuiting
 - c. Light fixture schedule
5. Other Deliverables:
 - a. Survey and geotechnical information are required as part of the Design Development.
 - b. Project Manual complete with all Division 01 – “General Requirements” sections and technical sections. “General Requirements” sections and technical sections. General Requirements sections unique to the project, such as including temporary facilities, and Supplementary Conditions, must be fully developed. With each technical specification section, for each product or material specified, include a photocopy of a cut sheet of the basis of design components and at least two acceptable components specified.

6. Energy Model/Energy Budget – Provide an updated EnergyPlus model and outputs with project assumptions. Document the EUI output from the energy model and comparison of the energy model to the current energy code as a percent to validate goals set in Schematic Design. EUI shall be broken into Equipment/Plug load, Lighting, HVAC and renewables. Utility budgets for GT gas, steam, chilled water and power shall also be updated. Changes to goals must be approved by the Director of Facilities/D&C and updated in the OPR as needed.
- B. **Construction Documents** deliverables must be appropriate to the project scope for a new building, substantiated addition or major renovation and include, at a minimum, the following:
1. Cover Sheet
 - a. Name, address of Owner, Construction Manager (if applicable), Architect, Consultants, Project Number
 - b. Vicinity map
 - c. Location map
 - d. Index to all drawings
 - e. Location Plan
 - f. Code Analysis information such as: Fire resistance plans and building code construction type and occupancy information
 - g. Abbreviation and symbol glossary
 2. Site Plan
 - a. A certified plot plan, (sealed by a Georgia licensed Land Surveyor)
 - b. A grading plan 1'-0" or 2'-0" increments with appropriate sections
 - c. Sedimentation Control and Storm Water Management Plans and profiles
 - d. Local governing utility standards included in all utility details
 - e. Standard details must be modified to suit project conditions. All non-applicable information must be deleted.
 - f. Existing and proposed electrical, gas, sewer, water, storm drainage, telephone and TV cable utilities must be identified.
 - g. Utility designs must show plan, profile and all fittings and details required by code and local government standards.
 - h. Include locations of detour signs for the duration of construction.
 3. Landscape
 - a. An overall site plan showing plantings, irrigation and drainage system, site lighting and all site development features.
 - b. Details and sections of all site development features, sidewalks, curbs, paving stones, bollards, ramps, exterior stairs, lawn areas showing seeding methods, etc.
 - c. All landscape conditions should be thoroughly detailed
 - d. A symbol glossary

- e. Planting schedule
 - f. Seeding schedule
 - g. Modify standard details to suit project conditions. Delete all non-applicable information.
4. Architectural
- a. A basic floor plan of the entire facility showing minimal detail with a grid or column reference system showing overall building layout dimensions, core spaces, numbered and named rooms, room square footage, floor opening penetrations, etc. Fire ratings of all partitions, fire doors, etc. should be clearly denoted.
 - b. A dimensioned floor plan locating all interior partitions and exterior wall partitions from the grid or column reference system. Floor plan should include room and workstation designations, interior and exterior door and window designations.
 - c. A dimensioned floor plan showing wire management system with openings located for voice, data, video and electrical and outlet locations.
 - d. Room wall elevations for all non-typical walls
 - e. Casework floor plan complete with schedule, details and elevations
 - f. Interior and exterior window, door and frame schedule, complete with elevations and details for all head, jamb and sill conditions.
 - g. Interior and exterior finish and color schedule (exposed finished mechanical and electrical items will be clearly addressed).
 - h. A reflected ceiling plan showing all grid, access doors, drapery tracks, light fixtures, grills, diffusers, sprinkler heads, security devices, fire alarm devices, intercom system, exit devices and acoustic treatment. Ceiling heights and type should be indicated on the reflected ceiling plan.
 - i. Details to illustrate transitions between finish materials and construction types. Major building sections in at least two directions. A sufficient number of details to clearly indicate the method of construction for all building components and include, but not be limited to: walls, floors, roofing assemblies, waterproofing systems, insulating systems, interior and exterior finishes, architectural details, interior stairs and elevators.
 - j. Interior signage locations must be shown on the floor plan complete with details and schedules.
 - k. Partition type schedule and sections details for all interior, exterior and floor wall conditions
 - l. Roof plan showing all roofing material, roof drains, overflows, access hatches, roof walk pads, roof drainage slopes and elevations, scuppers, skylights and mechanical and plumbing penetrations. Details must be provided for all edge, parapet and flashing conditions.
 - m. All exterior building elevations showing finish materials, exterior door and window openings and designations, lights, louvers, grilles, signage, speakers and other devices

- n. All structural members included in, or enclosed by the architectural details must be closely coordinated, with and the size verified by the structural engineer. Details must indicate the framing and furring method wherever possible.
 - o. All mechanical/electrical elements included in, or enclosed by the architectural details must be closely coordinated with and the size verified by the design engineer. Details must indicate the framing and furring method wherever appropriate.
5. Structural:
- a. A dimensioned foundation plan showing and locating in plan and in elevation all footing, foundations, foundation piers, caissons, grade beams, reinforcement with all layouts for masonry and anchor bolts.
 - b. A dimensioned floor plan for each floor, showing all beams, beam sizes, duct and piping penetrations, construction joints, expansion joints, edge conditions, imbedded anchors and frames thickened slabs, recessed slabs stair penetrations, elevator shafts, floor loading, top of structure elevation and reinforcement.
 - c. Footing, column, grade beam, caissons, piers, reinforcement, and beam schedules
 - d. Dimensioned to scale details showing all conditions, connections, and structural sizes
 - e. Shear walls clearly shown on plan and schedule if symbol code is used
 - f. Abbreviation and symbol glossary
 - g. Fastener/connection schedule
 - h. Elevations of all footings, elevations to top of all beams, columns, recesses and floors
 - i. Roof beam plan, elevator hoist beams

6. Mechanical
 - a. Abbreviation and symbol glossary
 - b. Mechanical equipment schedule
 - c. Exterior louver schedule, as coordinated with architectural louvers
 - d. Floor plans indicating ductwork with sizes, ductwork mechanical devices, beams for floor above with ductwork penetrations
 - e. Reflected ceiling plan showing final location of all ceiling mounted mechanical devices which include but are not limited to; diffusers, return air grilles and thermostats
 - f. Floor plan indicating the sprinkler and standpipe riser systems including all required pumps and control devices
 - g. Fire damper schedule and location of dampers on each floor
 - h. Ductwork sound attenuation schedule
 - i. Vibration isolation schedule
 - j. Terminal control box schedule, with electrical and air volume requirements
 - k. Chilled water, condenser, refrigerant, fuel oil, steam and gas riser piping floor plans and riser diagrams and schematics including pipe sizes. Piping schematics must be in large enough scale to clearly indicate all control devices, valves unions and miscellaneous appurtenance.
 - l. Areas of concentrated mechanical equipment must be enlarged from the basic floor plan to not less than $\frac{1}{4}$ "=1'0" illustrating detailed ductwork and equipment within the mechanical room in both plan and section views; coil access and filter access are to be shown to scale as verification of clearance.
 - m. Access doors both wall and ceiling, must be called out at each applicable location as coordinated with the architectural drawings (rated where applicable).
 - n. Floor plans should indicate housekeeping pads and weight of concentrated loads.
 - o. Duct/piping penetrations of all walls, floors, roofs, beams, columns and foundations must be coordinated with and verified by the structural engineer. Code complying fire stopping must be detailed for penetrations through fire rated assemblies.
 - p. Locate on the floor plans all controls system equipment and provide a panel and device schedule, indicator and panel graphics complete with sequence of operation system program diagram.
7. Plumbing:
 - a. Fixture/connection schedule
 - b. Abbreviations/symbol glossary

- c. Floor plans indicating domestic hot and cold water, storm, waste, vent and gas piping plans, including all valves, unions, fixtures, pipe sizes, and risers diagrams, etc.
 - d. Piping and insulation jacket dimensions are to be coordinated with architectural finishes and casework; all exposed piping is to be verified with the Architect.
 - e. Plan drawing of all water and sanitary branch piping for installation of interior equipment and fixtures.
 - f. Typical piping riser schematics for all gravity flow piping systems
 - g. Areas of concentrated plumbing equipment (hot water heaters, circulating pumps, etc.) must be enlarged from the basic floor plan to not less than ¼"=1'-0" detail in both plan and section views.
 - h. Access panels, doors and provisions in both walls and ceilings are to be shown on floor plans for all valves, cleanouts and caps, etc.
 - i. Connections to existing and new building utilities must be clearly shown. Requirements of governing utilities must be determined and clearly detailed and shown. Connection details and elevations must be checked and coordinated with applicable civil drawings.
 - j. Design details
 - k. Piping penetrations of all walls, floor, roofs, beams, columns and foundations must be coordinated with and verified by the structural engineer. Code complying fire stopping must be detailed for penetrations through fire rated assemblies.
8. Electrical:
- a. Lighting fixture schedule
 - b. Lighting control schedule, switches, emergency lighting
 - c. Floor Plan indicating all lighting fixture devices
 - d. Power riser diagram for interior lighting systems
 - e. Abbreviations and symbol glossary
 - f. Panel schedules with panel locations shown on the floor plan
 - g. Fan/motor control schedule/diagram
 - h. Floorplan showing location of all fire alarm device/panel schedule, indicator graphics, riser diagram including activated hardware and pull stations. Confirm activated hardware schedule.
 - i. Floor plan showing location of all intercom devices, panel schedule and location and program riser diagram
 - j. Floor plan showing location of all security devices, panel schedule and locations and riser diagram
 - k. Floor plan showing location of all intercom and TV outlets and devices
 - l. Power riser diagram and main distribution panel layout in large enough scale so each run can be clearly seen.

- m. Telephone board schedule and riser diagram coordinated to equipment size requirements and connection provisions to antenna and cable TV system.
 - n. Floor plan indicating wire management wiring for power, receptacles, voice, video and data communications including circuiting, and connections to systems furniture, etc.
 - o. Main service entrance connection diagram as verified and coordinated with the governing power utility; locations of services entrances and transforms must be verified with the Architect.
 - p. Areas of concentrated electrical equipment, and electric vault rooms in particular, must be enlarged from the basic floor plan to not less than 1/4"=1'0 and must be shown in plan and elevation.
 - q. Sheet notes must be applicable to each sheet. Standard notes and details must be modified to specific conditions.
 - r. Access to systems must be verified. Doors, panels or other provisions must be called out in all wall and ceiling locations for junction boxes, controls or any other device requiring access.
 - s. Raceway penetrations of all walls, floors, roofs, beams, columns and foundations must be coordinated with and verified by the structural engineer. Code complying fire-stopping must be detailed for penetrations through fire rated assemblies.
9. Energy Model/Energy Budget – Provide an updated EnergyPlus model and outputs with project assumptions. Document the EUI output from the energy model and comparison of the energy model to the current energy code as a percent to validate goals set in Design Development. EUI shall be broken into Equipment/Plug load, Lighting, HVAC and renewables. Utility budgets for GT gas, steam, chilled water and power shall also be updated. Changes to goals must be approved by the Director of Facilities/D&C and updated in the OPR as needed.

6.00 Construction Document Review and Archival Documents

- A. 75% completion of Construction Documents, submit the following:
 - 1. Two full size sets of black line on white bond reproductions of the Drawings.
 - 2. Two sets of the Project Manual.
- B. At 100% completion of Construction Documents, submit the following:
 - 1. Three full size sets of black line on white bond reproductions of the Drawings.
Three half size sets of black line on white bond reproductions of the Drawings.
 - 2. Two copies of the Project Manual.
 - 3. One CD-ROM(s) with all AutoCAD drawings and Project Manual.
- C. Archival Documents: At the completion of the Work submit the following:
 - 1. Record Set of Contract Documents (as issued for bid):
 - a. One sets of full size black line on white bond reproductions of the Drawings and Specifications.

- b. One set of half size black line on white bond reproductions of the Drawings and Specifications.
 - c. Two electronic copies of PDFs of all contract documents, including all bid documents and addenda.
 - d. Two electronic copies of all AutoCAD/Revit drawings of the contract documents, including all bid documents and addenda. All CAD drawings shall be whole and complete with NO Xrefs to symbols or other drawings. The format of the CAD file shall be AutoCad RVT or DWG. No other format will be accepted. All Revit sheets shall have and accompany DWG file.
2. As-Built Documents (Drawings and Specifications):
- a. All changes made to the contract documents, including building and utility line locations modified during construction, must be noted on the as-built documents.
 - b. Submit hard copies and electronic copies of the as-built drawings and specifications at the completion of the construction project with all change orders and as-built changes incorporated as follows:
 - c. Submit three hard copies (full size) of the as-built drawings and specifications. One copy shall be prepared for archive.
 - d. Submit two electronic PDF copies of the as-built drawings and specifications.
 - e. Submit two electronic copies of CAD files of the as-built drawings and. All cad drawings shall be whole and complete Revit BIM and AutoCAD files for each Revit Sheet with NO Xrefs to symbols or other drawings. The format of the CAD file shall be AutoCad RVT and DWG . No other format will be accepted. The characters shall be acceptable for Microsoft file names. After the file name a period (.) and then the file extension (dwg). Example B50docs1.PDF
 - f. Submit a completed copy of the GT Archive Entry Sheet. Obtain a copy of the “GT Archive Entry Sheet.xls” spread sheet from the Georgia Tech Facilities Web page <http://facilities.gatech.edu/standards-forms> The designer shall fill out all the information for each of the files for all electronic close out documents provided.
3. Project Close Out Documentation.
- a. The requirements for close-out documentation will vary from project to project but must include at a minimum:
 - b. Operation and Maintenance Manuals
 - c. Shop Drawings
 - d. Warranties
 - e. Project Submittals (Product data and schedules)
 - f. Testing Reports
 - g. Inspection Reports
 - h. Site Visit Reports

- i. Training (Videos, Sign in Sheets)
 - j. Project Progress Photos
 - k. Transmittals for Attic Stock.
 - l. Approved Interior Finish Materials and Samples.
 - m. Subcontractor Directory of all subcontractors and suppliers who worked on the project.
 - n. Any additional record documents as required in the Project Manual.
 - o. Submit three hard copies of all close out documents. One copy shall be prepared for archive. (See section 4 below.). Two copies shall be prepared in ring binders, or as directed by the GT project manager.
 - p. Submit two CD Rom copies of all close-out submittals in a PDF format, with files organized by specification division.
 - q. Obtain a copy of the Excel spreadsheets from the Ga Tech Facilities Web page <http://www.facilities.gatech.edu/standards-forms>
 - r. Complete the GT Archive Entry Sheet, listing all of the electronic files submitted. The file names shall be no more than 8 characters. The characters shall be acceptable for Microsoft file names. After the file name insert a period (.) and then the file extension (dwg). Example B50docs1.PDF.
4. Direction for Packaging Files and Drawings for Archive:
- a. Packaging Boxed Files Directions:
 1. Label all folders (i. e. with division number, etc.).
 2. Files must be assembled within the box so that lids my completely close in order to fit Records Center shelving.
 3. Records must be packed in standardized boxes designed to fit the Records Center’s shelving.
 4. The required boxes are medium duty and can accommodate both legal and letter sized documents.
 5. Boxes can be filled with crumpled paper to ensure files stand up.
 - b. Two sources for boxes that meet the records center requirements are below. Our preference is the Hollinger Boxes.
 1. (Hollinger Box #RSB 12 white #10760)
<http://www.hollingermetaledge.com/modules/store/index.html?dept=566&cat=592&searchname=record%20storage%20boxes&searchid=&searchtype=C&cart=135784942733071315>
 2. (Fellows Bankers Box)
<http://www.fellows.com/Fellows/site/products/ProductDetails.aspx?id=12770>
 - c. Number the boxes on the outside of the box with permanent marker (1 of 4, 2 of 4, 3 of 4, etc.) to identify how many boxes are in the complete set.
 - d. Put the project name and building number on the outside of the box using a permanent marker.

- e. Directions for Packaging Drawings:
 - 1. Drawings should be submitted for archive in brown bags.
 - 2. A source for bags is below:
http://www.planbags.com/images/Plan_Bags_Fax_Order.pdf
 - 3. No rubber bands should be used on drawings inside the bags.
 - 4. Do not seal the bags shut.
 - 5. Number the bags on the outside of the bag (1 of 4, 2 of 4, 3 of 4, etc.) using a permanent marker to identify how many bags are in the complete set/series.
 - 6. Put the project name and building number on the outside of the bags using a permanent marker.

7.00 Typical Program Requirements

- A. Building Design and Circulation:
 - 1. All building entrance doors including bridges must be locked to entry from the exterior, and never locked to exit from the interior per the exit requirements of the applicable Code. Bridges between buildings may not serve as minimum required exits. All exterior doors to have electric strikes, and the main entrances doors to have card readers. For electric strike and card reader specifications see Section 16740 of the Engineering Design Standards of this manual.
 - 2. Provide access to all building service closets from common public corridors.
 - 3. Open Office areas using systems furnishings should be configured in suites and have locked door security.
 - 4. Gender Neutral Toilet Room – All new and major renovation projects will include a minimum of one gender neutral toilet room to comply with 2010 ADA standards, chapter 6 and the Georgia Accessibility Code. Where feasible, the gender neutral toilet room should be located near the required male and female toilet rooms.
 - 5. Wellness Room – All new and major renovation projects will include a minimum of one wellness room. Provide a sink, countertop, under counter refrigerator and lounge chair to comply with 2010 ADA standards, Chapter 6 and the Georgia Accessibility Code. Where feasible, the wellness room should be located near the required male and female toilet rooms.
- B. Verify the fire rating of walls enclosing mechanical & electrical systems. Specify in architectural documents that all fire rated assembly work to be sealed with an approved fire stop foam at all wall and floor penetrations by pipes, conduits, ducts, etc. Specify fire rated walls to have fire rating notice stenciled above ceiling line per Building Code.
- C. Coordinate locations for recessed fire extinguisher cabinets, emergency lighting and exit signs. Fire extinguisher units to be approved by Campus Fire Marshal.

- D. The color of all wall and ceiling mounted fire alarm devices shall be as designated in section 283100, 4.01,item 9. The color of the lettering of all exit signs to be as shown in section 265100.
- E. Ceiling plenums must have adequate clearances for ductwork and other building system components. Corridor ceiling height should be at 9'-0" but a minimum of 8'-0" clear.
- F. Provide the following custodial closets and custodial storage rooms:
 - 1. For buildings greater than 150,000 square feet provide one 12' x 12' custodial closets per floor. Also provide one 15' x 15' custodial storage room located near the loading dock.
 - 2. For buildings greater than 75,000 square feet but less than 150,000 square feet provide one 10' x 8' custodial closet per floor. Also provide one 12' x 12' custodial storage room located near the loading dock.
 - 3. For buildings less than 75,000 square feet, provide one 9' x 6' custodial closet per floor. Also provide one 9' x 9' custodial storage room near the loading dock.
 - 4. Each custodial closet to have a floor mop sink and space for owner supplied shelving and mop holders.
 - 5. Buildings with laboratories may require areas for handling the delivery and return of gas bottles. Provide empty bottle holding areas including chain restraints.
 - 6. On each floor adjacent to vending areas and break rooms provide an area 25 square feet in size for recycling containers.
- G. Machine Width Requirements:
 - 1. Glass Front Beverage 54"
 - 2. Bottle or Can Beverage 42"
 - 3. Snack Machine 41"
 - 4. Changer 24"
 - 5. All machines require minimum of 42" depth
 - 6. Typical arrangement would include 1 glass front beverage and 1 snack = 95" width 6" clearance on sides for door opening (if against a wall). Only in high-volume situations are changers needed
 - 7. 1 data port per machine for BuzzCard (if volume warrants)
 - 8. Each Beverage Machine requires Dedicated 20 Amp Circuit 120V (Beverage/Snack can share a circuit)
 - 9. If machines are facing one another - must accommodate ADA diameter for turnaround (layout not preferred) Heavy volume locations may require additional planning and more machines. Reference 2010 ADA Standards for Accessible Design, Chapter 3 – Section 304.
- 10. Contact Kira Freeman, kira.freeman@gatech.edu

H. Stair/Guard Design:

1. In buildings with concrete structure, monumental stairs should be concrete. Enclosed Exit stair construction should be concrete filled pan treads. In buildings with structural steel frame, steel stairs should be concrete filled pan treads.
2. Monumental Stairs should have closed risers; however, glass or perforated metal risers are acceptable.
3. Provide roof access from at least one stair. In cases with no stair and only an access hatch, provide for a latch with a pad lock.
4. Stairs used for frequent communication may have upgraded finishes, i.e. rubber treads, Scuff Master grade wall finish, etc., with maintenance considerations a priority.
5. Guard height- The Design Professional will review the guard height adjacent to the elevated walking surfaces with Georgia Tech prior to completion of the Design Development phase. The guard height is measured vertically from the walking surface to the top of the guard.

I. Building Donor Recognition:

1. Georgia Tech buildings must provide opportunities for Donor Recognition. The exterior of a building or portions of a building will have a prominent space for the donor name on the building. The graphic design is a specialty that will be directed by Design and Construction and may be performed as a separate task from the base design and construction. Plan interior spaces for donor recognition, signage, recognition plaques, et al, that will conform to standards adopted by the Georgia Tech Office of Development Stewardship and the Georgia Tech Office of Facilities.
2. Restroom Accessories – The following items are “Owner Furnished Contract Installed” (OFICI): GT will provide soap dispensers, paper towel dispensers, toilet paper dispensers, and hand sanitizer dispensers. Reference ADA Standards, Chapter 3 – Section 309 and Chapter 6 – Section 604.7 for all accessories.
3. Install defibrillators at all new buildings. AE is to coordinate specs and locations with EH&S.

8.00 Sole Source Items

A. Architectural items

1. Door hardware
 - a. 087100: best hardware lock cores are required to maintain and be consistent and compatible with previously-established campus standards.
 - b. Retail Renters: all space owned by Georgia Tech must be keyed using the Georgia Tech master key system.

B. Landscape/ Hardscape items

1. These items are required to maintain consistency with established standards identified in the Georgia Tech landscape master plan.
 - a. Pedestrian & roadway lights
 - b. Benches
 - c. Bike racks
 - d. Trash cans/recycling containers/HVAC

C. 230900 JCI Controls

- a. A campus-wide contract has been established with Johnson Controls to provide the facility management system under state of Georgia DOAS contract # 9020017203. This DOAS contract has been consigned to this project.
- b. This product is an extension of an existing system for M&V verification. In order to conform to and be compatible with the existing system this product sole source is required. This is a design standard in the Georgia tech “Yellow Book” Manufacturer: Infodev
- c. 238000: ULTRASONIC ENERGY METER
This product is an extension of and existing systems for utility metering and billing system. In order to conform too and be compatible with the existing system this product sole source is required. Manufacturer: Siemens
- d. 238000: STEAM CONDENSATE DATALOGGER
This product is an extension of an existing system for utility metering and billing. In order to conform to and be compatible with the existing system, this product sole source is required. Manufacturer: Yokogawa.
 1. “Installation/Integration contractor is required to notify the Facilities Management IT department via email at askIT@facilities.gatech.edu when installing/configuring Yokogawa data loggers in new or remodeled Georgia Tech campus buildings.”
- e. 238000: CO2 SENSORS
This product is employing aggressive demand control ventilation, which requires the use of very reliable and accurate co2 sensors. The desired sensors have a patented infrared technology that provides much better accuracy than other CO2 sensors on the market and these sensors are self-calibrating. Other CO2 sensors on the market are not self-calibrating, thus will require recalibration and maintenance over time. The continued calibration of the CO2 sensors is critical to the performance of the demand control ventilation system; this is one of the essential sustainable features of this building. There are no known additional equal manufacturers. Manufacturer: TELAIRE.

D. Electrical items

1. 264400: POWER & ENERGY METERS

This product is an extension of and existing systems for utility metering and billing system. In order to conform to and be compatible with the existing system, this product sole source is required. Manufacturer: POWERLOGIC.

END OF SECTION

013329 SUSTAINABLE DESIGN REPORTING

1.01 Peach Green Building Rating System

A. Georgia-based Materials and Products:

1. Utilize the following spreadsheet to document the percentage of Georgia-based materials and products (building materials used in a project that are harvested, extracted, or manufactured in the State of Georgia). The general contractor shall track the materials and costs of each Georgia-based product used on the project and provide documentation to ensure compliance and obtain product data sheets. To comply, one of the three options below must be checked, “Yes” (Harvested, Extracted and/or Manufactured in Georgia). Determine if the project will use the Default Materials Value or Actual Materials Value to assess compliance with the 10% minimum guideline requirements.
2. Default Materials Value: Based on the total construction costs (hard costs for CSI Master Format 2004 Divisions 2-10 only)
 - a. Default Materials Value: _____ = total construction cost * 0.45
3. Actual Materials Value: Based on actual materials cost (excluding labor and equipment) (hard costs for CSI Master Format 2004 Divisions 2-10 only)
 - a. Actual Materials Value: _____

Product	Total Product Cost	Harvested in Georgia Yes or No	Extracted in Georgia Yes or No	Manufactured in Georgia Yes or No

B. Water-use Reduction:

1. The design team for all new buildings and major renovations planned at GT shall provide water savings calculations for plumbing fixtures and landscaping.
2. All major facility projects shall be designed, constructed, and commissioned to achieve a 20 percent reduction in water use when compared to water use based on the following plumbing fixtures:
 - a. Lavatory with metered faucet 0.25 gallon per metering cycle
 - b. Lavatory non-metered faucet 0.5 GPM at 60 psi
 - c. Shower head 2.5 GPM at 80 psi
 - d. Sink faucet 2.2 GPM at 60 psi
 - e. Urinal 1.0 gallon per flushing cycle
 - f. Water closet 1.6 gallons per flushing cycle
 - g. Pre-rinse spray valves shall comply with ASME A112.18.1 standard of 1.6 GPM or less
3. Commercial steam cookers, dishwashers, clothes washers are exempt.
4. Plumbing fixture water efficiency calculations shall demonstrate the percent of water savings for both the design case and the baseline case, the default for both male and female occupants is 3 uses per day of flush and flow fixtures (1 water closet use and 2 urinal uses for males and 3 water closet uses for females), 3 lavatory faucets uses for each male and female, 0.1 uses for showers, and 1 use for kitchen sinks. The total fixture uses by all occupants must be consistent in the design and baseline cases. The default value for total annual work days is 260 days. This value must be consistent in the design and baseline cases.
 - a. Number of occupants shall be calculated based number of full and part time staff, students, a transients (visitors, etc.). Calculate the number of occupants based on an 8- hour period. Each occupant occupying the building for 8-hours shall be equal to 1.0 Full Time Equivalent (FTE). Part time occupants FTE shall be calculated based on the number of hours per day occupant is in the building divide by 8.
5. Landscape Design: Landscape designers shall perform soil and evapotranspiration analysis to determine appropriate plant material and design the landscape with native or adapted plants to reduce or eliminate irrigation requirements. Landscape design shall endeavor to select plants that can survive on natural rainfall in the region.

6. Water-use Reduction EXAMPLE Calculation:

Design Case					
Flush Fixture	Daily Uses	Flow Rate (GPF)	Duration (flush)	Occupants	Water Use (gal)
Ultra low-flow water closet (male)	1	0.8	1	150	120
Ultra low-flow water closet (female)	3	0.8	1	150	360
Waterless urinal (male)	2	0	1	150	0
Waterless urinal (female)	0	0	1	150	0
Flow Fixture	Daily Uses	Flow Rate (GPM)	Duration (seconds)	Occupants	Water Use (gal)
Conventional Lavatory	3	2.5	12	300	450
Kitchen Sink	1	2.5	12	300	150
Shower	0.1	2.5	300	300	375
Total Daily Volume (gal)					1455
Annual Work Days					260
Total Annual Volume (gal)					378,300

Baseline Case					
Flush Fixture	Daily Uses	Flow Rate (GPF)	Duration (flush)	Occupants	Water Use (gal)
Conventional Water Closet (male)	1	1.6	1	150	240
Conventional Water Closet (female)	3	1.6	1	150	720
Conventional Urinal (male)	2	1	1	150	300
Conventional Urinal (female)	0	0	1	150	0
Flow Fixture	Daily Uses	Flow Rate (GPM)	Duration (seconds)	Occupants	Water Use (gal)
Conventional Lavatory	3	2.5	15	300	563
Kitchen Sink	1	2.5	15	300	188
Shower	0.1	2.5	300	300	375
Total Daily Volume (gal)					2386
Annual Work Days					260
Total Annual Volume (gal)					620,360

Water Use Reduction (%)	
--------------------------------	--

7. Water-use Reduction Calculation Template:

Design Case					
Flush Fixture	Daily Uses	Flow Rate (GPF)	Duration (flush)	Occupants	Water Use (gal)
_____ (male)	_____	_____	_____	_____	_____
_____ (female)	_____	_____	_____	_____	_____
_____ (male)	_____	_____	_____	_____	_____
_____ (female)	_____	_____	_____	_____	_____
Flow Fixture	Daily Uses	Flow Rate (GPM)	Duration (seconds)	Occupants	Water Use (gal)
_____	_____	_____	_____	_____	_____
_____	_____	_____	_____	_____	_____
Total Daily Volume (gal)					_____
Annual Work Days					260
Total Annual Volume (gal)					_____

Baseline Case					
Flush Fixture	Daily Uses	Flow Rate (GPF)	Duration (flush)	Occupants	Water Use (gal)
_____ (male)	_____	_____	_____	_____	_____
_____ (female)	_____	_____	_____	_____	_____
_____ (male)	_____	_____	_____	_____	_____
_____ (female)	_____	_____	_____	_____	_____
Flow Fixture	Daily Uses	Flow Rate (GPM)	Duration (seconds)	Occupants	Water Use (gal)
_____	_____	_____	_____	_____	_____
_____	_____	_____	_____	_____	_____
Total Daily Volume (gal)					_____
Annual Work Days					260
Total Annual Volume (gal)					_____

Water Use Reduction (%)	_____
--------------------------------	-------

8. Water-use Reduction Points:

- a. The project will be recognized for exemplary performance in achieving the next incremental percentage threshold for water-use reduction. All major facility projects that are designed, constructed, and commissioned or modeled to achieve between a 25 percent to 95 percent reduction in water use when compared to water use based on plumbing fixture selection in accordance with water consumption rates for plumbing fixtures in this section will be eligible for this recognition. The project will be awarded points toward the Georgia Peach Green Building Rating System according to the threshold achieved in water-use reduction. Refer to the following table to determine eligible points earned for this incentive.

Water-Use Reduction Percentage	Points Earned
15%	0 (Requirement)
25%	2
35%	4
45%	6
55%	8
65%	10
75%	12
85%	14
95%	16
100%	20

C. Energy Efficiency:

1. All new buildings and major renovations planned at GT shall at a minimum comply with ASHRAE 90.1-2010. This standard is 30% higher energy efficiency across all building types than ASHRAE 90.1 -2004, the State of Georgia’s current minimum energy performance requirement (See Pacific Northwest National Laboratory report 20405 for more information). The State of Georgia Energy Efficiency and sustainable Construction Standards for State Buildings (also known as Peach Green Building Rating System) encourages all state-funded facility projects to optimize energy efficiency, conserve energy and utilize local and renewable energy sources where determined to be cost effective (utilizing life cycle cost analysis with a payback of no more than ten years).

2. The design team for all new buildings and major renovations planned at GT shall provide Energy Modeling, Life Cycle Cost Analysis, and percentage of Greenhouse Gas Emissions (GHG) over the minimum requirements. Based on these analysis the project designers shall develop recommendations that exceed minimum energy and water efficiency requirements for GT’s considerations. The findings shall be prioritized based on Life Cycle Cost (LLC) with the lowest LLC listed highest first and to the highest LLC listed last in the recommendations in response to the Governor’s Energy Challenge. The Challenge commits all state agencies in Georgia to reduce energy consumption in state facilities 15 percent below 2007 levels by the year 2020.
 - a. Energy Model (Whole Building Energy Simulation) shall be utilized to demonstrate improvement options in response to the Governor’s Energy Challenge. Opportunities to improve building performance shall include, at a minimum, the follow building systems: building enclosure, lighting, plug loads, process loads, and HVAC alternatives for the proposed design that achieve in combination a minimum reduction in GHG emissions of 15% utilizing EPA Energy Star Target finder and the associated energy savings from the Energy Model when compared with the baseline building performance in accordance with ASHRAE 90.1-2010 Appendix G. eQuest (<http://www.doe2.com/equest/>) Whole Building Energy Simulation software shall be utilized to demonstrate compliance with the Yellow Book requirements.
 1. For the purpose of this analysis, process energy is considered to include, but is not limited to, office and general miscellaneous equipment, computers, elevators and escalators, kitchen cooking and refrigeration, laundry washing and drying, lighting exempt from the lighting power allowance (e.g., lighting integral to medical equipment) and other (e.g., waterfall pumps).
 2. Process loads must be identical for both the baseline building performance rating and the proposed building performance rating. However, project teams may follow the exceptional calculation method (ANSI/ASHRAE/IESNA Standard 90.1-2007 G2.5) to document measures that reduce process loads. Documentation of process load energy savings must include a list of the assumptions made for both the base and the proposed design, and theoretical or empirical information supporting these assumptions.
 3. Regulated (non-process) energy includes lighting (for the interior, parking garage, surface parking, façade, or building grounds, etc. except as noted above), heating, ventilation and air conditioning (HVAC) (for space heating, space cooling, fans, pumps, toilet exhaust, parking garage ventilation, kitchen hood exhaust, etc.), and service water heating for domestic or space heating purposes.
 - b. Energy Modeling and Life Cycle Cost Analysis Checklist:
 1. Project Name: _____
 2. Project Number: _____

3. Note: The Energy Modeling Checklist serves to certify compliance with the recommendation of Section 4.1 – Energy Modeling and Life Cycle Cost Analysis, Recommendations contained in Peach Green Building Rating System. Utilize the following spreadsheets to determine energy savings from baseline design to proposed design alternatives. This Checklist should be completed at the end of the Design Document phase of the project. The form must be submitted to the agency owner at completion if this recommendation will be pursued.

Checklist 4.1.a - State of Georgia Energy Performance Comparison Chart
Baseline Design

Building Information

Orientation	<input type="text"/>	Roof SRI (Solar Reflective Index)	<input type="text"/>
Shading Devices	<input type="text"/>		

Envelope Information: (List R-Values for the following components)

Flat Ceiling/Roof	<input type="text"/>	Slope/Vault Ceiling	<input type="text"/>
Exterior Wall	<input type="text"/>	Attic Knee Wall Sheathing	<input type="text"/>
Attic Knee Wall	<input type="text"/>	Basement Continuous	<input type="text"/>
Basement Stud Wall	<input type="text"/>	Crawlspace Continuous	<input type="text"/>
Crawlspace Stud Wall	<input type="text"/>	Above Grade Mass Wall	<input type="text"/>
Foundation Slab	<input type="text"/>	Floor Over Unconditioned Space	<input type="text"/>
Cantilevered Floor	<input type="text"/>	Other Insulation	<input type="text"/>

Fenestration:

Window U-Factor	<input type="text"/>	Window SHGC	<input type="text"/>
Skylight U-Factor	<input type="text"/>	Skylight SHGC	<input type="text"/>
Glazed Door U-Factor	<input type="text"/>	Opaque Doors U-Factor (<50% glazed)	<input type="text"/>

Mechanical Summary

Water Heater Type	<input type="text"/>
Gas	<input type="text"/>
Electric	<input type="text"/>
Other (explain)	<input type="text"/>

Electrical Summary

Lighting Controls	<input type="text"/>
Daylighting & Controls	<input type="text"/>
Lighting Power Density (wsf)	<input type="text"/>
Efficient Lighting Fixtures	<input type="text"/>

Number of Heating & Cooling Systems (Air Handlers)

Heating Type:		Efficiency:	<input type="text"/>
Gas	<input type="text"/>	AFUE	
Air Source Heat Pump	<input type="text"/>	HSPF	
Other	<input type="text"/>		
Cooling System Type (Direct Expansion, Heat Pump, Geothermal, Etc.)			<input type="text"/>
Cooling System SEER:			<input type="text"/>

Total Heating Load (Btu/h based on ACCA Man. J or other approved methodology)	<input type="text"/>
Total Cooling Load (Btu/h based on ACCA Man. J or other approved methodology)	<input type="text"/>
Cooling Sensible Load (Btu/h)	<input type="text"/>
Cooling Latent Load (Btu/h)	<input type="text"/>
Total Air Handler CFM (Based on Design/Calculations)	<input type="text"/>

TOTAL ENERGY CONSUMPTION OF DESIGN ALTERNATIVE:

*This form may be used to compare design alternatives to exceed the standards set forth in ASHRAE 90.1-2004 by 30% where it is determined that such 30% efficiency is cost effective based on a life cycle cost analysis with a payback at no more than ten years.

Checklist 4.1.b - State of Georgia Energy Performance Comparison Chart
Proposed Design

Building Information

Orientation	<input type="text"/>	Roof SRI (Solar Reflective Index)	<input type="text"/>
Shading Devices	<input type="text"/>		

Envelope Information: (List R-Values for the following components)

Flat Ceiling/Roof	<input type="text"/>	Slope/Vault Ceiling	<input type="text"/>
Exterior Wall	<input type="text"/>	Attic Knee Wall Sheathing	<input type="text"/>
Attic Knee Wall	<input type="text"/>	Basement Continuous	<input type="text"/>
Basement Stud Wall	<input type="text"/>	Crawlspace Continuous	<input type="text"/>
Crawlspace Stud Wall	<input type="text"/>	Above Grade Mass Wall	<input type="text"/>
Foundation Slab	<input type="text"/>	Floor Over Unconditioned Space	<input type="text"/>
Cantilevered Floor	<input type="text"/>	Other Insulation	<input type="text"/>

Fenestration:

Window U-Factor	<input type="text"/>	Window SHGC	<input type="text"/>
Skylight U-Factor	<input type="text"/>	Skylight SHGC	<input type="text"/>
Glazed Door U-Factor	<input type="text"/>	Opaque Doors U-Factor (<50% glazed)	<input type="text"/>

Mechanical Summary

Water Heater Type	<input type="text"/>
Gas	<input type="text"/>
Electric	<input type="text"/>
Other (explain)	<input type="text"/>

Electrical Summary

Lighting Controls	<input type="text"/>
Daylighting & Controls	<input type="text"/>
Lighting Power Density (wsf)	<input type="text"/>
Efficient Lighting Fixtures	<input type="text"/>

Number of Heating & Cooling Systems (Air Handlers)

Heating Type:		Efficiency:	<input type="text"/>
Gas	<input type="text"/>	AFUE	
Air Source Heat Pump	<input type="text"/>	HSPF	
Other	<input type="text"/>		
Cooling System Type (Direct Expansion, Heat Pump, Geothermal, Etc.)			<input type="text"/>
Cooling System SEER:			<input type="text"/>

Total Heating Load (Btu/h based on ACCA Man. J or other approved methodology)	<input type="text"/>
Total Cooling Load (Btu/h based on ACCA Man. J or other approved methodology)	<input type="text"/>
Cooling Sensible Load (Btu/h)	<input type="text"/>
Cooling Latent Load (Btu/h)	<input type="text"/>
Total Air Handler CFM (Based on Design/Calculations)	<input type="text"/>

TOTAL ENERGY CONSUMPTION OF DESIGN ALTERNATIVE:

*This form may be used to compare design alternatives to exceed the standards set forth in ASHRAE 90.1-2004 by 30% where it is determined that such 30% efficiency is cost effective based on a life cycle cost analysis with a payback at no more than ten years.

4. The project will be recognized for exemplary performance in achieving incremental percentage thresholds for energy efficiency based on the standards set forth in ASHRAE 90.1-2004. All major facility projects may be designed, constructed, and commissioned or modeled to exceed the standards set forth in ASHRAE 90.1-2004. Any such project that exceeds the standards set forth in ASHRAE 90.1-2004 by 30 percent or more must demonstrate that such efficiencies are cost effective based on a life cycle cost analysis with a payback at no more than ten years. The project will be awarded points toward the Georgia Peach Green Building Rating System according to the threshold achieved in energy cost savings based on the standards set forth in ASHRAE 90.1-2004. Refer to the following table to determine eligible points earned for this incentive.
5. Energy Model Points:

Energy Cost Savings Percentage	Points Earned
0%	0
5%	5
10%	10
15%	15
20%	20
25%	25
30%	30
35%	35
40%	40
45%	45
50%	50

D. Commissioning:

1. All new buildings and major renovations planned at GT shall be commissioned. A major renovation is defined as renovation of $\geq 10,000$ GSF or a project budget \geq One Million Dollars. The commissioning authority (CxA) shall, at a minimum, commission the following systems; mechanical systems (heating, ventilating, air conditioning, and refrigeration equipment and controls, heat recovery and renewable energy systems, laboratory systems, test and balance verification), electrical systems (lighting and daylighting controls and renewable energy systems), and plumbing systems (plumbing fixtures, landscaping

irrigation controls, potable water pump stations, sump pumps, domestic hot water systems, rainwater collection systems, and onsite waste water treatment systems). Other systems that may be considered in the commissioning process include the building enclosure, dangerous gas monitoring; normal, standby and emergency power systems, voice data, fire alarm; metering and submetering of utilities serving the building, mechanical conveyances. The commissioning authority shall evaluate the installation and performance of all commissioned systems to ensure that the building and systems perform in accordance with the Owner's Project Requirements (OPR) for new construction and major renovations or the Current Facility Requirements (CFR) for existing buildings not being substantially renovated. The Commissioning requirements contained in Section 01 91 00 of the Yellow Book are binding on all parties.

2. Commissioning Documentation Required to be Submitted: (see following page)

Commissioning Checklist

Project Name: _____

Project Number: _____

Note: The Commissioning Checklist serves to certify compliance with the requirement of Section 1.1 – Commissioning, Requirements. This Checklist should be completed at the end of the construction phase of the project, as outlined in the Typical Time Frame column below. The form must be submitted to the agency owner at completion.

Commissioning Task	Responsible Team Member	Typical Time Frame	Seasonal Climate Conditions	Responsible Team Member Sign Off	Completion Date
Prepare OPR	Owner	Prior to beginning Design Documents.			
Prepare BOD	A/E Team	During the Design Phase.			
Prepare a Cx Plan	CxA	During the Design Phase.			
Incorporate Cx Requirements into Construction Documents	CxA	CxA will review existing project specifications and incorporate commissioning requirements.			
Introduction and task assignment meeting, i.e. Cx kickoff	CxA	When all contractors have been selected. This meeting is to introduce everyone needed in the Cx process and define roles and responsibilities.			
Verification of Installation	CxA	CxA will be walking the job periodically as the job progresses looking for system wide issues that may prove to be functional problems later.			

Completion of start-up test sheets	CxA	This should happen when the equipment begins to arrive on the job. It is the contractor’s responsibility to properly fill them out and return to the CxA. Factory start-up sheets are preferable. If the contractor does not have anything to use, the CxA will supply the sheets for them.			
Functional performance tests and verification of TAB Reports	CxA / Contractors	Require the participation of all sub contractors and CxA designated personnel. This should take place prior to the CO. If any problems arise during testing, some amount of time may be required to correct the problems and this should also be considered before CO date.			
Summary (final) commissioning report	CxA	Provided by the CxA after substantial progress has been made with resolving the discrepancies and deficiencies identified during functional performance testing.			

I have complied with the Energy Efficiency and Sustainable Construction Standards for State Buildings requirements for commissioning.

Signed (Responsible Team Member): _____ **Date:** _____

Printed Name: _____ **Organization:** _____

Additional Commissioning – Checklist

Project Name: _____

Project Number: _____

Note: The commissioning tasks listed on the following checklist include the additional tasks that must be completed and signed off on to earn the incentive points, outlined in Section 5.1 – Commissioning, Incentives. This Checklist should be completed at the end of the construction phase of the project, as outlined in the Typical Time Frame column below.

The form must be submitted to the agency owner at completion.

Commissioning Task	Responsible Team Member	Typical Time Frame	Seasonal Climate Conditions	Responsible Team Member Sign Off	Completion Date
Conduct a commissioning design review prior to mid-construction documents	CxA	CxA will conduct a second design review at 50% to 95% of Construction Documents			
Review contractor submittals applicable to systems being commissioned	CxA	During construction phase, CxA will review submittals for compliance with OPR and construction documents			
Develop a systems manual for the commissioned systems	CxA	During construction phase, prior to occupancy			
Verify that the requirements for training are completed	CxA	End of construction phase, prior to occupancy			

I have complied with the Energy Efficiency and Sustainable Construction Standards for State Buildings recommendations for additional commissioning.

Signed (Responsible Team Member): _____ **Date:** _____

Printed Name: _____ **Organization:** _____

1.02 Prohibited Content Installer Certification

- A. This Form Applies to Indoor Air Contaminant Reduction Requirements.
1. Contaminate content of field-installed adhesives and sealants.
 2. Contaminates contained in composite wood and agrifiber products containing ; added urea- formaldehyde content of composite wood and agrifiber products, defined as particleboard, plywood, medium density fiberboard, wheat board, strawboard, panel substrates, door cores, and laminating adhesives; applies to manufacturers/suppliers and installer.
 - a. Procedure: Because installers are allowed and directed to choose accessory materials suitable for the applicable installation, each installer of work on this project is required to certify that their use of these particular materials complies with the requirements and to provide assurance that the products used do not contain the prohibited content.

2.01 Product Certification

_____Adhesives: I certify that the installation of the work of my firm on this project has not required the use of any adhesives. OR (certify the above or the below, not both)

_____Adhesives: I certify that my firm has NOT installed any adhesive with VOC content exceeding that specified in Section 01 5721 of the Yellow Book on this project; product data and MSDS sheets for all adhesives used are attached.

_____Joint Sealants: I certify that the installation work of my firm on this project has not required the use of any gunnable or pourable joint sealants. OR (certify the above or the below, not both)

_____Joint Sealants: I certify that my firm has NOT installed any joint sealant with VOC Content exceeding that detailed in Section 01 5721 of the Yellow Book on this project; product data and MSDS sheets for all joint sealants used are attached.

_____Composite Wood and Agrifiber Products: I certify that the work of my firm on this project has not required the use of any composite wood or agrifiber products, as defined above. OR (certify the above or the below, not both)

_____Composite Wood and Agrifiber Products: I certify that the composite wood and agrifiber products, as defined above, furnished or installed by my firm DO NOT contain any ADDED urea-formaldehyde binder; product data and MSDS sheets for products used, whether specified or not, are attached.

CERTIFIED BY: (Installer/Manufacture/Supplier Firm)

Firm Name: _____

Print Name: _____

Signature: _____

Title: _____

More information is available at:

<http://www.dca.state.ga.us/development/constructioncodes/publications/energy-efficiency-and-sustainable-construction-standards-final.pdf>

END OF SECTION

013546- INDOOR AIR QUALITY SCHEDULING/SEQUENCING REQUIREMENTS

1.01 Overview

- A. Georgia Tech (GT) requires implementation of Construction IAQ to prevent indoor air quality problems resulting from the construction process. Poor control of indoor air quality (IAQ) during the construction activities produces odors, dust, air pollutants, and moisture intrusion and absorption into building materials which can cause health and comfort concerns to construction workers as well as building occupants. To minimize the negative effects and reduce risk, the construction team must take measures to manage the IAQ during the construction process. By effectively managing the IAQ during construction, health and comfort issues that can result from the construction process can be reduced significantly.

1.02 Summary

- A. Section Includes:
 - 1. Product requirements for indoor construction and finishing materials.
 - 2. Final construction products list.
 - 3. Construction site management.
 - 4. Indoor Environmental Consultant qualifications.
 - 5. Scheduling and product installation sequencing.
 - 6. Operation of HVAC systems during construction.
 - 7. Product installation.
 - 8. Building flush-out.
 - 9. Indoor air quality testing.
 - 10. Documentation and reporting.

1.03 References

- A. American Conference of Government Industrial Hygienists (ACGIH).
- B. American National Standards Institute/American Society of Heating, Refrigeration, and Air- Conditioning Engineers (ANSI/ASHRAE):
 - 1. 52.2 – Method of Testing General Ventilation Air-Cleaning Devices for Removal Efficiency by Particle Size.
 - 2. 55 – Thermal Environmental Conditions for Human Occupancy.
 - 3. 62.1 – Ventilation for Acceptable Indoor Air Quality.
 - 4. 62.2 – Ventilation and Acceptable Indoor Air Quality for Low-Rise Residential Buildings.
- C. GREENGUARD Environmental Institute (GREENGUARD) – Indoor Air Quality Certification Program.
- D. Sheet Metal and Air Conditioning Manufacturer’s Association International (SMACNA).

- E. United States Environmental Protection Agency (EPA):
 - 1. Compendium of Methods for the Determination of Air Pollutants in Indoor Air.
 - 2. National Ambient Air Quality Standard, Code of Federal Regulations, Title 40, Part 50.

1.04 Description

- A. This section outlines Indoor Air Quality (IAQ) actions required by the contractors to minimize contaminants generated during construction and the potential impact on the building occupants after completion. Odors and dust produced during the construction activities can cause health and comfort concerns and measures will be taken to manage the IAQ during construction.

1.05 Definitions

- A. **Indoor Air Quality (IAQ):** According to the U.S. Environmental Protection Agency and National Institute of Occupational Safety and Health, the definition of good indoor air quality includes (1) introduction and distribution of adequate ventilation air; (2) control of airborne contaminants; and (3) maintenance of acceptable temperature and relative humidity. According to ASHRAE Standard 62-2013, indoor air quality is defined as “air in which there are no known contaminants at harmful concentrations as determined by cognizant authorities and with which a substantial majority (80 percent or more) of the people exposed do not express dissatisfaction.”
- B. **Type 1 Finishes:** Materials and finishes which have a potential for short-term levels of off gassing from chemicals inherent in their manufacturing process, which are applied in a form requiring vehicles or carriers for spreading, or release a high level of particulate matter in the process of installation and/or curing. Type 1 Finishes include, but are not limited to the following:
 - 1. Composite wood products, specifically including particleboard from which millwork, wood paneling, doors or furniture may be fabricated.
 - 2. Adhesives, sealants, and glazing compounds, specifically those with petrochemical vehicles or carriers.
 - 3. Wood preservatives, finishes, and paint.
 - 4. Control and/or expansion joint fillers and sealants.
 - 5. All hard finishes requiring adhesive installation.
 - 6. Gypsum board and associated finish processes.

- C. **Type 2 Finishes:** “Fuzzy” materials and finishes which are woven, fibrous, or porous in nature and tend to absorb chemicals off-gassed by Type 1 finishes or may be adversely affected by particulates. These materials become "sinks" for harmful substances which may be released much later, or collectors of contaminants that may promote subsequent bacterial growth. Type 2 Finishes include, but are not limited to the following:
 - 1. Carpet and padding.
 - 2. Fabric wall covering
 - 3. Insulation exposed to the air stream
 - 4. Acoustic ceiling materials
 - 5. Fabric covered acoustic wall panels
 - 6. Upholstered furnishings
- D. Materials that can be categorized as both Type 1 and Type 2 materials shall be considered to be Type 1 materials.
- E. **Dry Products:** Products used in a solid state, including gypsum board, carpet, acoustical panels and tiles, and textiles.
- F. **MERV:** Minimum Efficiency Reporting Value.
- G. **Priority Products:** Products known to be high chemical emitters, long-term emitters, and those expected to present emissions in high amounts (high surface area).
- H. **Threshold Limit Value (TLV):** Industrial Work Place Standard as defined by ACGIH.
- I. **Wet Products:** Products used in a liquid or semi-liquid state, including adhesives, joint sealers, paints, and coatings.

1.06 Submittals

- A. Construction IAQ Management Plan: Submit four (4) copies of a Draft Plan to the Commissioning Authority (CxA). Develop the Working Plan, incorporating comments from the Draft Plan. Submit four (4) copies of the Working Plan to CxA.
 - 1. Indicate in Section 7 of the IAQ Management Plan the control measures that will be utilized in the building to help maintain good IAQ during construction and during the pre-occupancy phase in accordance with this specification.
- B. Supplementary Construction Schedule Information: Include in schedule of construction activities HVAC duct ruff-in, sequence of finishes applications, and operation of HVAC equipment in addition to construction schedule. Schedule information shall be provided for each HVAC zone.
 - 1. An HVAC zone is that part of any floor area served by a single air handling unit.
 - 2. Indicate and schedule types and durations of temporary HVAC operation proposed. Show schedule for commissioning procedures and all temporary usages of building mechanical systems, identifying types of filtration used and schedule of filter replacement and change outs.
- C. Material Safety Data Sheets (MSDSs): Provide MSDSs on all Type 1 Finishes and carpet systems.

- D. Final Construction Products Lists:
 - 1. Submit list of proposed indoor construction and finishing products.
 - 2. Include strategies for minimizing use of wet products.
 - 3. Obtain approval by Project Architect prior to installation of products.
- E. Indoor Air Quality Test Report:
 - 1. Provide copies of Indoor Air Quality Test Report from Indoor Environmental Consultant.
 - 2. Include in report:
 - a. Study design including methodology for determination of air sampling locations and duration of sampling.
 - b. Summary of sampling and analytical methods employed.
 - c. Copy of field sampling logs.
 - d. Summary of methods and results used to determine that ventilation system hours operated, start and stop times, and outside airflow rates supplied to the facility, any air quality test, air test methodology, and duration of air testing.
 - e. Laboratory analytical data for each contaminant and summary table showing compliance with specified criteria.

1.07 Quality Assurance

- A. Finishes Installation Scheduling: As part of the Pre-construction Conference, the contractor will discuss the Supplementary Construction Schedule required under this section. The purpose of this agenda item is to assure understanding of the importance of sequencing of finishes to the overall Indoor Air Quality of the facility and to secure preliminary approval of the Owner for scheduling and installation requirements for on-site work.
- B. Provide written notification of product requirements to subcontractors and suppliers of interior construction and finishing products.
- C. Indoor Environmental Consultant Qualifications:
 - 1. GT employ and pay for an Indoor Environmental Consultant to perform specified indoor air quality testing.
 - 2. Minimum 5 years of experience in conducting indoor environmental quality evaluations of non-industrial buildings.
 - 3. Retain Certified Industrial Hygienist (CIH) on staff to review and sign test reports.

1.08 Delivery, Storage and Handling

- A. Storage Area:
 - 1. Designated secure storage area to facilitate protection of stored absorptive products.
 - 2. Clearly identify storage area. Keep dry, clean, and orderly; prevent contamination of products.
 - 3. Monitor storage areas for contamination; correct problems and implement preventative measures.
- B. Products:
 - 1. Protect absorptive materials from moisture damage before, during, and after installation.
 - 2. Immediately remove products exhibiting stains, mold, mildew, or other evidence of water or moisture damage from site.

1.09 Work Included

- A. This section defines special construction scheduling/sequencing requirements and procedures necessary to assure achievement of designed Indoor Air Quality (IAQ) levels for the completed project required by the Construction IAQ Management Plan developed by the Contractor.
 - 1. Scheduling - Special construction scheduling involves defined and controlled sequencing of finishes applications to ensure dissipation of emissions from finishes that off-gas significant quantities of harmful material during curing, to separate these effects from the installation of adsorptive materials that would act as a "sink" for storage and subsequent release of these unwanted substances into building spaces and mechanical systems after project occupancy.

2.01 General

- A. Interior Construction and Finishing Products; in purchasing products, give preference to:
 - 1. Products designed and manufactured in manner to produce least harmful and irritating effects.
 - 2. Products certified by GREENGUARD Environmental Institute as Low Emitting. For products that are not GREENGUARD Certified, provide a test, which at maximum is performed one year prior to installation, to ensure conformance to GREENGUARD standard emission values.
 - 3. Products providing lowest practical yet technologically achievable emissions of particulates and chemical vapors, as defined in following paragraphs.
- B. Maximum Chemical Emission Values for Products In Commercial or Retail Buildings:
 - 1. Emission rate calculations: Assume 32 cubic meters as volume for determination of product loading.

2. Product emission rates and modeling for predicted exposure concentrations: As measured in milligrams/square meter per hour ($\text{mg}/\text{m}^2 \cdot \text{hr}$) at anticipated loading (square meter/cubic meter [m^2/m^3] within building. Predicted indoor concentrations shall be based on building modeling parameters of 0.72 air changes per hour (ACH). The product shall produce indoor air concentration levels less than the amounts specified for each substance within seven (7) days of installation.
 3. Total VOC emission rate: Maximum total volatile organic compounds (VOC) of 0.05 milligrams/cubic meter (mg/m^3).
 4. Total aldehydes: Maximum 0.1 parts per million (ppm).
 5. Formaldehyde: Maximum 0.05 parts per million (ppm).
 6. 4-Phenylcyclohexene (4-PC): Maximum 0.0065 milligrams/cubic meter (mg/m^3) or 0.1 parts per billion (ppb).
 7. Styrene: Maximum 0.07 milligrams/cubic meter (mg/m^3).
 8. For individual Volatile Organic Compounds (VOCs) not listed above: Shall produce an air concentration level less than 1/10th of the Threshold Limit Value (TLV) at the anticipated product loading in the building within seven (7) days of installation.
 9. Regulated pollutants: Maximum air concentration as promulgated by National Ambient Air Quality Standard for primary and secondary outdoor air pollutants.
 10. Identified carcinogens and reproductive toxins: Below levels of no significant risk according to evaluation protocols established by EPA or approved State and public health organizations.
- C. Maximum Chemical and Particle Emission Values for Products In Educational, Daycare, Healthcare, or Otherwise Sensitive Environments:
1. Emission rate calculations: Assume 231 cubic meters as volume for determination of product loading.
 2. Product emission rates and modeling for predicted exposure concentrations: As measured in milligrams/square meter per hour ($\text{mg}/\text{m}^2 \cdot \text{hr}$) at anticipated loading (square meter/cubic meter [m^2/m^3] within building. Predicted indoor concentrations shall be based on building modeling parameters of 0.9 air changes per hour (ACH) and a 0.9 ventilated volume fraction. The product shall produce indoor air concentration levels less than the amounts specified for each substance within seven (7) days of installation except for formaldehyde. Formaldehyde criteria are established so that emission levels reach 0.014 ppm (13.5 ppb) within 14 days of installation (meeting CA 1350 requirements).
 3. Total VOC emission rate: Maximum total volatile organic compounds (VOC) of 0.022 milligrams/cubic meter (mg/m^3).
 4. Total aldehydes: Maximum 0.043 parts per million (ppm).
 5. Formaldehyde: Maximum 0.0135 parts per million (ppm) within 14 days of installation.

6. Total Phthalates: Maximum 0.01 milligrams/cubic meter (mg/m³). Total phthalates are defined as the total response of a specific target list of phthalates including dibutyl (DBP), diethylhexyl (DEHD), diethyl (DEP), butylbenzyl (BBP), di-octyl (DOP), and dimethyl (DMP) phthalates (conducted using a modified phthalate specific analytical method, OSHA 104).
7. Total Particles: Maximum 0.02 milligrams/cubic meter (mg/m³). This is applicable only to fibrous, particle-releasing products with exposed surface area in air streams (determined using a “forced air” test with specific test method).
8. For individual Volatile Organic Compounds (VOCs) not listed above: Shall produce an air concentration level less than 1/100 of the Threshold Limit Value (TLV) and less than ½ of the California Chronic REL at the anticipated product loading in the building within seven (7) days of installation.

3.01 Preparation

- A. Certify in writing to the GT’s Representative that interior environmental control has been implemented as specified below and that required conditions are being maintained, and obtain the Owner’s Representative’s approval before starting installation of interior finishes.
- B. Coordination: The Contractor is responsible to schedule and coordinate the work of all finishes installers to assure compliance with the requirements of this specification section.

3.02 Cleaning During Construction

- A. Remove accumulated water as soon as possible. Keep work areas dry. Porous materials such as insulation shall be protected from moisture. Porous materials that get wet shall be dried out completely—immediately after moisture is observed. Porous items such as duct insulation that remain damp for more than a few hours shall be replaced. Equipment such as terminal units, which have duct insulation in the air stream, shall be stored on pallets (away from water) and shall be sealed with plastic prior to installation. Before installation, check for possible damage to equipment from high humidity. Repair or replace any damaged equipment.
- B. Suppress dust in the construction area with wetting agents or sweeping compounds. Regularly clean the dust from the site using a damp rag, wet mop or vacuum equipped with a high efficiency particulate filter or wet scrubber. Remove spills or excess applications of solvent- containing products as soon as possible.
- C. If weather or plumbing leaks result in interior of building becoming wet:
 1. Ensure that building is properly dried out prior to installation of any additional materials into the space.
 2. Inspect installed materials for mold and mildew.
 3. Affected materials less than 10 square feet in area: Remediate materials according to accepted industry practices.
 4. Affected materials 10 square feet or more in area: Employ certified remediation firm to remove materials from site.

- D. For projects incorporating new construction in an existing space, follow the procedures outlined in the Sheet Metal and Air Conditioning National Contractors Association (SMACNA) *IAQ Guidelines for Occupied Buildings Under Construction*, Chapter 3, ANSI/SMACNA 008- 2008 (Chapter 3).

3.03 Final Cleaning

- A. Complete the following cleaning operations before requesting inspection for certification of Substantial Completion:
 - B. Remove labels that are not permanent.
 - C. Clean transparent materials, including mirrors. Remove excess glazing compounds. Replace chipped or broken glass.
 - D. Clean exposed finishes to a dust-free condition, free of stains, films, and foreign substances. Sweep concrete floors with a broom to ensure cleanliness.
 - E. Vacuum carpeted surfaces and wax resilient flooring.
 - F. Wipe surfaces of mechanical and electrical equipment. Remove excess lubrication. Clean plumbing fixtures. Clean light fixtures, lamps, globes, and reflectors.
 - G. Clean Project site, yard, and grounds, in areas disturbed by construction activities. Sweep paved areas; remove stains, spills, and foreign deposits.

3.04 Interior Environmental Control

- A. If the HVAC system is utilized during construction, provide and maintain controlled interior environment in accordance with the following requirements before beginning installation of interior finish.
 - 1. The supply air system must have MERV 8 filters in place. Filters shall fit tightly together and shall have no gaps between filters. Damaged filters shall be replaced immediately. Integrity of the filters shall be checked daily from initial start-up until the final punch list is complete.
 - 2. Return air openings shall have MERV 8 filter media installed during construction.
 - 3. Replace construction air filters with clean MERV 8 air filters as needed until building flush-out. Clean exposed surfaces of diffusers, registers and grilles prior to occupancy.
 - 4. Install final filters at beginning of building flush-out.
- B. Schedule shipment and delivery of products based on actual construction progress to minimize time products are stored on site.
- C. Prepare and staff building site for delivery of products.
- D. Inspect products upon delivery for conformance to Final Construction Materials List and to ensure that they are free from water and moisture damage and properly stored.
- E. Use the least practical amount of wet materials.
- F. Do not install dry materials until wet materials have been installed and allowed to dry to greatest extent practical.
- G. Choose drying times so that specified pollutant emission rates are achieved prior to installation of dry materials.

- H. Install solvent containing materials during periods during which building is unoccupied. Schedule installation as early as possible during construction to allow for maximum off-gassing prior to building occupancy or re-occupancy.
- I. Install high-VOC emitting products prior to installation of porous and fibrous products, or protect with polyethylene sheeting, properly sealed.
- J. Complete installation of interior finishing materials two to four weeks prior to building occupancy. Continuously flush out building with fresh air for two to four weeks.
- K. Provide temporary ventilation during touch-up operations; extend building flush-out for minimum of four days after touch-up is complete.

3.05 Operation of HVAC Systems During Construction in Occupied Buildings

- A. Depressurize construction area at rate at least 10 percent greater than rate of supply or pressurize existing spaces, whichever is more feasible.
- B. Erect supplemental containment barriers if pressurization is not adequate to control construction dust and odors in occupied areas.
- C. Ensure that construction equipment and staging areas are away from air intakes for existing construction.
- D. Temporarily seal intake dampers for existing space when high-emitting construction activities are performed near outdoor air intakes for existing construction.
- E. During demolition or construction in existing spaces:
 - 1. Do not operate building HVAC systems in affected areas.
 - 2. Temporarily seal supply and return openings with plastic sheeting.
 - 3. If system must be operational during demolition or construction, install temporary MERV 8 filters in return openings in accordance with LEED Guidelines; maintain in clean condition.

3.06 Building Flush-Out

- A. If weather conditions permit, upon completion of construction, but prior to occupancy, contractor shall perform a flush-out of the building utilizing the HVAC system. The flush-out shall supply a minimum 14,000 CFM/ft² of outside air to the building prior to occupancy. Throughout flush-out period outside air shall maintain a temperature of at least 60°F and relative humidity no higher than 60%.
- B. If 14,000 CFM/ft² of outside air cannot be supplied to the building prior to occupancy, a minimum of 3,500 CFM/ft² of outside air shall be provided. Following occupancy, outside air shall be supplied constantly while occupied at a rate of no less than 0.3 CFM/ft² until the balance of the 14,000 CFM/ft² has been supplied. During each day of flush-out during occupancy, flush-out shall begin no less than 3 hours prior to occupancy and be continuous throughout occupied period.
- C. Following completion of interior finishes and installation of new furnishings, flush building with 100 percent clean outdoor air for two to four weeks prior to occupancy. If time does not permit a two to four week flush-out period, the design and construction team shall designate whatever time is available for building flush (even if it is as minimal as 24 hours).
- D. Install new MERV 8 filtration media prior to beginning the flush-out procedure. After flush-out, install new MERV 8 filtration media, except for those filters processing only outdoor air.

3.07 Indoor Air Quality Testing

- A. Perform testing after completion of construction and installation of new furnishings, but before Owner occupancy, using protocols established by reputable standard setting or method development organizations such as state and federal agencies and reputable nongovernmental organizations such as the GREENGUARD Environmental Institute or ASTM.
- B. Conduct testing prior to Owner occupancy but during normally occupied hours.
- C. Operate building HVAC system at normal daily start and stop times at minimum outside airflow for occupied mode for duration of testing.
- D. Number of Air Sampling Locations: Minimum of one per 25,000 square feet or for each contiguous floor area, and no less than two samples. Include areas with least ventilation and greatest presumed source strength.
- E. At each location, collect samples at to 6 feet above floor over minimum 4 hour period.
- F. Demonstrate that contaminant concentrations do not exceed following maximum concentration limits:

Contaminant	Maximum Concentration Limit
Carbon Dioxide *	10,300/ventilation rate
Carbon Monoxide	9 ppm and maximum 2 ppm above outdoor levels
Total Volatile Organic Compounds (TVOC)	Maximum 500 micrograms/cubic meter
Formaldehyde	Maximum 27 parts per billion
4-Phenylcyclohexene (4-PCH)	Maximum 6.5 micrograms/cubic meter
Other Individual VOC's	Below odor and/or sensory irritation threshold and maximum 1/10 TLV
Total Aldehydes	Maximum 100 parts per billion
Total Particles (PM 10)	Maximum 50 micrograms/cubic meter

* Carbon dioxide monitoring is required only if building is occupied during testing. Ventilation rate is outdoor air requirement per person. Carbon dioxide measurement is differential between indoor and outdoor conditions, based on occupancy type as defined by ANSI/ASHRAE 62.1 and 62.2 -2007.

- G. For each sampling location where maximum concentration limit is exceeded, conduct additional flush-out with outside air and retest specific contaminant until maximum concentration limit is achieved. Collect samples for retesting from original sampling location.

END OF SECTION

015721- INDOOR AIR QUALITY (IAQ) DESIGN AND PERFORMANCE REQUIREMENTS

1.01 GT IAQ Requirements

- A. Construction Indoor Air Quality, During Construction
- B. Construction Indoor Air Quality, Before Occupancy
- C. Low Emitting Materials

2.01 Reference Standards

- A. ASHRAE 52.2 – Method of Testing General Ventilation Air-Cleaning Devices for Removal Efficiency by Particle Size; 2007
- B. ASHRAE 62.1 – Ventilation for Acceptable Indoor Air Quality; 2007
- C. ASHRAE 129 – Measuring Air-Change Effectiveness; 1997
- D. ASTM E 779 – Standard Test Method for Determining Air Leakage Rate by Fan Pressurization; 2003
- E. SMACNA – IAQ Guideline for Occupied Buildings under Construction; 2007, ANSI/SMACNA 008-2008 (Chapter 3).
- F. South Coast Air Quality Management District (SCAQMD) Rule #1168
- G. Green Seal Standard 36

3.01 Definitions

- A. Absorptive Materials: Gypsum board, acoustical ceiling tile and panels, carpet and carpet tile, fabrics, fibrous insulation, and other similar products.
- B. Contaminates: Gases, vapors, regulated pollutants, airborne mold and mildew.
- C. Particulates: Dust, dirt and other airborne solid matter.
- D. Wet Work: Concrete, plaster, coatings and other products that emit water vapor or volatile organic compounds during installation, drying or curing.

4.01 Products

- A. VOC restricted products within weatherproofing of the building
- B. Adhesives, sealants, sealer coatings
 - 1. General adhesives and sealants should comply with SCAQMD Rule # 1168, architectural sealants have a VOC limit of 250 g/L.
 - 2. Aerosol adhesives should comply with Green Seal Standard 36, 55% VOC by weight.
- C. Carpet, carpet pad, carpet tile
 - 1. Products shall be certified by the Carpet and Rug Institute Green Label Plus program
- D. Paints and coatings
 - 1. General paints and coatings shall comply with Green Seal Standard 11, generally 50 g/L.
 - 2. Anti-corrosive paints and coatings shall comply with Green Seal Standard 03, generally 250 g/L.

3. Clear coatings should comply with SCAQMD Rule #1113, generally 27 ppb.
- E. Hard surface flooring
 1. Products shall be certified by FloorScore.
 2. Flooring adhesives and grouts shall comply with SCAQMD Rule #1113, generally 50 g/L.
- F. Composite wood and agrifiber products used either alone or as part of another product.
 1. No urea-added formaldehyde
- G. Auxiliary Air Filters: MERV 8 during construction; MERV 13 prior to occupancy

5.01 Procedures

- A. Follow Yellow Book Section 01 35 46 and develop an IAQ Management Plan that
 1. Identifies construction activities and other potential sources of odor and dust
 2. Identifies areas likely affected by odors and dust and methods of control
 3. Describes construction ventilation, including type and duration, use of permanent HVAC systems, types of filters, and replacement of filters
 4. Identifies interior finishes that generates odors, moisture, vapors or is susceptible to absorption of odors and vapors, indicate air handling zone, sequence of application, and curing times
 5. Before occupancy, follow one of these two options
- B. Follow Yellow Book Section 01 35 46 and perform a building flush out that provides 14,000 cubic feet of outdoor air per square foot at internal temperature of at least 60 degrees with a relative humidity of less than 60%
- C. Conduct baseline IAQ testing after construction ends and prior to occupancy using testing protocols consistent with the EPA Compendium of Methods for the Determination of Air Pollutants in Indoor Air or the ISO method listed in the table below. Testing must be done in accordance with one standard; project teams may not mix requirements from the EPA Compendium of Methods with ISO Methods.

Contaminant	Maximum Concentration	EPA Compendium method	ISO method
Formaldehyde	27 parts per billion	IP-6	ISO 16000-3
Particulates (PM10)	50 micrograms per cubic meter	IP-10	ISO 7708
Total volatile organic compounds (TVOCs)	500 micrograms per cubic meter	IP-1	ISO 16000-6
4-Phenylcyclohexene (4-PCH)*	6.5 micrograms per cubic meter	IP-1	ISO 16000-6
Carbon monoxide (CO)	9 part per million and no greater than 2 parts per million above outdoor levels	IP-3	ISO 4224
* This test is only required if carpets and fabrics with styrene butadiene rubber (SBR) latex backing are installed as part of the base building systems.			

- D. For each sampling point where the maximum concentration limits are exceeded, conduct an additional flush-out with outside air and retest the noncompliant concentrations. Repeat until all requirements are met. When retesting noncompliant building areas, take samples from the same locations as in the first test, although it is not required.
1. All measurements must be conducted prior to occupancy, but during normal occupied hours with the building ventilation system started at the normal daily start time and operated at the minimum outside air flow rate for the occupied mode throughout the test.
 2. All interior finishes must be installed, including but not limited to millwork, doors, paint, carpet and acoustic tiles. Movable furnishings such as workstations and partitions should be in place for the testing, although it is not required.
 3. The number of sampling locations will depend on the size of the building and number of ventilation systems. The number of sampling locations must include the entire building and all representative situations. Include areas with the least ventilation and greatest presumed source strength.
 4. Air samples must be collected between 3 and 6 feet (between 1 and 2 meters) from the floor to represent the breathing zone of occupants, and over a minimum 4-hour period.

END OF SECTION

017419- CONSTRUCTION WASTE MANAGEMENT AND DISPOSAL

1.01 Waste Management Requirements

- A. Georgia Tech requires Construction and Demolition (C&D) waste recycling, salvage, and disposal. Projects involving construction and demolition of buildings and other structures that generate waste associated with the construction phase shall generate the least amount of trash and waste economically feasible. Construction and Demolition waste includes construction products and material waste, construction product and materials packaging, and construction office waste. Hazardous wastes shall be disposed with in accordance with federal, state, and local laws and regulations as well as applicable construction codes; and that the most stringent requirements are followed.
- B. Designers shall provide specifications that establish clear direction to contractor's management of C&D for the recycling of all nonhazardous construction and demolition debris. Design specifications shall direct the construction team to develop a construction waste management plan for Designer and GT approval. The construction waste management plan must identify the materials (listed below in section C) that will be diverted from landfills. This plan must also address whether the recycled materials will be sorted on-site or leave the site commingled and provide a tracking methodology the General Contractor will implement to ensure C&D materials to be recycled reach the intended recycling centers, and specific reporting requirements that demonstrate achievement of GT goals of diverting eighty- five (85%) percent of the C&D waste stream away from landfills. C&D waste consisting of packaging (paper, cardboard, boxes, plastic sheet and film, wood crates, plastic pails, and polystyrene) shall be 100% recycled.
- C. Required Recycling, Salvage and Reuse: The following may not be disposed of in landfills or by incineration:
1. Aluminum and plastic beverage containers
 2. Corrugated cardboard
 3. Wood pallets
 4. Clean dimensional wood: may be used as blocking or furring
 5. Untreated wood studs, joists, plywood, oriented strand board, wood paneling and trim, land clearing debris, including brush, branches, logs and stumps
 6. Concrete: Crush, maximum size of $\frac{3}{4}$ " and use as aggregate, sub-base material or fill
 7. Bricks: Crush to a maximum size of $\frac{3}{4}$ " and use as landscape cover, sub-base material or fill.
 8. Concrete masonry units: May be used on project if whole, or crushed, maximum size of $\frac{3}{4}$ " and used as sub-base material or fill
 9. Asphalt paving: May be recycled for project or for other projects
 10. Metals, including packing banding, metal studs, sheet metal, structural steel, piping, reinforcing bars, door frames and other items made of steel, iron, galvanized steel, stainless steel, aluminum, copper zinc, lead, brass and bronze
 11. Glass

12. Gypsum drywall and plaster
13. Carpet, carpet cushion, carpet tile and carpet remnants, both new and removed
14. Rigid foam insulation
15. Windows, doors and door hardware
16. Plumbing fixtures
17. Mechanical and electrical equipment
18. Florescent lamps and light bulbs
19. Acoustical ceiling tile and panels
20. Roof ballast and membrane
21. Packaging

Georgia Tech C&D Recycling Report

Project Name	
Job Site	
Contractor Name	
Date	

C&D Activity Reporting

Material	Category	Quantity	Company Name	Cost (Revenue)/Ton	Total Cost

Total Waste:	% Salvaged:	% Recycled:
--------------	-------------	-------------

Total Percentage Diverted from Landfills
Please include copies of weight tickets and other supporting documentation.
Date Received:_____ Date Recorded:_____

Received by:_____ Recorded By:_____

END OF SECTION

017801 COMMISSIONING CLOSEOUT PROCEDURES

1.01 Introduction

- A. The correct documentation at the end of a project is critical to the operation and maintenance of the finished project. This section further defines the requirements of the project team to deliver to Georgia Institute of Technology (GT) the following documentation necessary for operation, maintenance and future modifications to the project.

1.02 Description

- A. Closeout includes completion of commissioning requirements in preparation for final completion and final payment. Completion of commissioning activities is directly related to final acceptance and documentation must be completed in accordance with contract documents.
- B. The section includes the following administrative and procedural requirements:
 - 1. O&M format
 - 2. O&M documentation
 - 3. Guidance in preparing and submitting information
 - 4. Development and delivery process
 - 5. Updating of changes
 - 6. System Manual documentation from Construction team.

1.03 Prerequisites to Final Acceptance

- A. All Test, Adjust, and Balance work and the commissioning requirements contained in the OPR/CFR and project contract document must be complete prior to final acceptance, unless approved in writing by GT. Exceptions to this are any required seasonal or approved deferred testing. This includes for all building systems and assemblies, but is not limited to:
 - 1. Completed and signed manufacturers start-up forms and Commissioning Construction Checklist documentation
 - 2. Receipt of requested trend log data
 - 3. Receipt of final approved TAB report
 - 4. Completion of commissioning testing
 - 5. Completion of training of Owner's personnel in accordance with Section 01 79 00 Demonstration and Training required and accepted by Owner.
 - 6. Submission of the approved O&M manuals
 - 7. All identified deficiencies have been corrected or are approved by the Owner to be accepted from this milestone. This includes resolution of deficiencies noted in the commissioning issues log.

- B. Single line drawing illustrating the following:
 - 1. HVAC water and air side of the complete system illustrating the path of an air or water molecule through the entire path including location of system components (filters, fans/pumps/ sensors, valves, dampers, etc. used to control, operate, and maintain the system on one sheet of paper or electronic graphic.
 - 2. Plumbing system domestic water system illustrating the distribution of water molecule through the entire path including location of system components of isolation and control valves, back flow preventers, sensors, water hammer arrestors, trap primers, cleanouts, pumps, expansion tanks, etc. required to control, operate, and maintain the system on one sheet of paper or electronic graphic.
 - 3. Fire suppression system illustrating the distribution of water molecule through the entire path including location of system components of isolation and control valves, back flow preventers, fire pump, fire department connection, and post valve indicator required to control, operate, and maintain the system on one sheet of paper or electronic graphic.
- C. The Owner will determine the date of final acceptance after reviewing the CxP's recommendation for final acceptance.
- D. Commissioning activities are non-compensable and cannot be a cause for delay claims.

1.04 Record Document Submittals

- A. Installation, O&M manuals: Submit three (3) complete sets of O&M manuals in printed and electronic media; two (2) printed and electronic media retained by the Owner and one (1) printed and electronic media retained by the Contractor. Electronic media will be on a CD-ROM or DVD-ROM disk. Electronic media shall be a searchable pdf document. The Table of Contents shall have links which will provide direct connection to the sections of the pdf.
- B. Submittals shall include, but not be limited to, the following information:
 - 1. Building Enclosure
 - a. Submittals (including all shop drawings) of the building enclosure elements shall be provided in accordance project contract documents for enclosure components and systems.
 - b. Description of enclosure components accompanied with easily read drawings illustrating each component and component name.
 - c. Completed as-built drawings of all enclosure components.
 - d. Recommended installation instructions (installation manuals) and maintenance procedures and their recommended frequency for this site-specific application.
 - e. Original purchase order number; date of purchase; name, address, and phone number of vendor; warranty information.
 - f. Technical data sheets for the materials used to construct the building enclosure (wind load limits, resistance to corrosion, permeability, etc.).

- g. Provide manufacturer's test results for components and assemblies illustrating compliance with design requirements including associated test protocols.
 - h. Completed field checklists for all building enclosure components and systems.
 - i. Detailed warranty documentation for all building enclosure components (roofs, wall cladding, fenestrations, doors, etc.).
2. HVAC Systems
- a. Submittals (including all shop drawings) in accordance project contract documents.
 - b. Completed as-built drawings of all HVAC systems and components.
 - c. Complete installation manuals and start up information for the type and model number for each system, equipment and component provided.
 - d. Additional information regarding function of the equipment, not already contained in the Operation and Maintenance, including functional parameters (input, output) at design load and part loads conditions, manufacturer's recommendations for calibration of sensors contained in equipment installed, and allowable operational parameters (operational minimums). Information shall be included the submittal table of contents.
 - e. Recommended maintenance procedures and their recommended frequency for this site- specific application.
 - f. Recommended list of spare parts, part numbers, and the place(s) from which they can be obtained.
 - g. Original purchase order number; date of purchase; name, address, and phone number of vendor; warranty information.
 - h. Any other information needed for the preparation of documents supporting the management of operation and maintenance programs.
 - i. As applicable: Provide manufacturer's test results for equipment supplied including test protocols.
 - j. Complete as-built control drawings with points list, valve schedules, schematics, control system architecture and full sequences of operation.
 - k. Seasonal start-up and shutdown, manual and restart operation procedures
3. Plumbing Systems
- a. Provide submittals (including all shop drawings) in accordance project construction documents.
 - b. Provide completed as-built drawings of all plumbing systems including location of isolation and control valves, sensors, water hammer arrestors, trap primers, cleanouts, pumps, expansion tanks, etc.
 - c. Installation, operation and maintenance manuals including start up information for the type and model number for each system, equipment and component provided.

- d. Provide detailed illustration, e.g. exploded diagram of components, fixtures, vales, etc. installed. Information shall be easily read drawings accompanied by a clear description of each component.
 - e. Description of function, manufacture recommended maintenance schedule, allowable operational parameters, relevant start-up, functional operating parameters (input, output). This information shall be included the submittal table of contents. Recommended list of spare parts, part numbers, and the place(s) from which they can be obtained.
 - f. Original purchase order number; date of purchase; name, address, and phone number of vendor; warranty information.
4. Fire Suppression System
- a. Building floor plan indicating location of fire sprinkler emergency shut off valve.
5. Electrical Systems
- a. Installation, operation and maintenance manuals, including start up, and programming information for the type and model number for each electrical system, equipment and component provided.
 - b. Completed as-built drawings of all electrical systems including location of junction/pull boxes, lighting controls, etc., modifications to distribution panel, updated distribution schedules, power distribution, lighting circuits, etc. Short circuit analysis and final breaker settings for electrical distribution system.
 - c. Recommended maintenance procedures and their recommended frequency for this site- specific application.
 - d. Recommended list of spare parts, part numbers, and the place(s) from which they can be obtained.
 - e. Original purchase order number; date of purchase; name, address, and phone number of vendor; warranty information.
 - f. As applicable: Provide manufacturer's test results for equipment supplied including test protocols.
 - g. Provide Fire Alarm System Documentation as required by NFPA 72 Inspection, Testing and Maintenance requirements including but not limited to record of completion or revision to the original record of completion.

2.01 Preparation

- A. The commissioning process requires detailed O&M documentation. Documentation required by this section and Yellow Section 019100 shall be provided in accordance with ASHRAE, a complete O&M documentation package shall include the following documents:
 1. O&M Documentation Directory
 2. Emergency Information
 3. Operating Manual
 4. Maintenance Manual

5. Test Reports
 6. Construction Documents
- B. All O&M submittals are to be developed in accordance with the detailed instructions provided in the ASHRAE Guideline 4-2008, Preparation of O&M Documentation for Building Systems.
- C. The GC shall compile O&M manuals for every piece of equipment and components of the commissioned building systems and assemblies including building enclosure documentation in the following format:
1. Quantity: 3 complete sets, each set containing a printed version and an electronic version of O&M manuals for every piece of equipment and building operating or electrical system.
 2. Format: 8 ½" x 11" loose leaf binders with electronic copy on electronic media. Each binder shall be clearly labeled on the spine. Use as many as required . Do not overload binders. There shall be dividers with permanently marked tabs of card stock separating each section and sub section. Tab labels shall not be handwritten. Electronic media will be on a CD-ROM or DVD-ROM disk. Electronic media shall be a searchable pdf document. The Table of Contents shall have links which will provide direct connection to the sections of the pdf.
 3. There shall be a title page and table of contents in the front of each binder noting the contents.
 4. There shall be a main tab for each specification section in each binder.
 5. Directly after the specification section number tab, there shall be the equipment or component ID sub-tab for each piece of major equipment (or group, if small or numerous) or a component tag sub-tab for each building enclosure system. These sub-tabs shall be similar to the specification section tabs but of a different color.
 6. Behind each equipment ID sub-tab or component tag sub-tab shall be the following sections, in the given order, divided by a double weight colored sheet labeled with the title of the section.
 - a. Contractor: The first page behind the equipment or building enclosure component sub- tab shall contain the name, address and telephone number of the manufacturer and installing contractor and the 24-hour number for emergency service for all equipment or components in this section, identified by equipment, type, or manufacturer's designation.
 - b. Submittal and Product Data: This section shall include all approved submittal data, cut sheets and appropriate shop drawings. If submittal was not required for approval, descriptive product data shall be included.
 - c. Project Manual Divisions 22, 23 and 26 O&M Instructions: These shall be the written manufacturer's data with the model and features of this installation clearly marked and edited to omit reference to products or data not applicable to this installation. This section shall include data on the following:

1. Installation, startup and break-in instructions.
 2. All starting, normal shutdown, emergency shutdown, manual operation, seasonal changeover and normal operating procedures and data, including any special limitations.
 3. O&M and installation instructions that were shipped with the unit.
 4. Preventative maintenance and service procedures and schedules.
 5. Troubleshooting procedures.
 6. A parts list, edited to omit reference to items which do not apply to this installation.
 7. A list of any special tools required to service or maintain the equipment.
 8. Performance data, ratings and curves.
 9. Warranty, which clearly lists conditions to be maintained to keep warranty in effect and conditions that would affect the validity of the warranty.
 10. Any service contracts issued.
- d. Project Manual Divisions 07 & 08 O&M Instructions: These shall be the written manufacturer's data with the model and features of this installation clearly marked and edited to omit reference to products or data not applicable to this installation. This section shall include data on the following:
1. O&M and installation instructions that were shipped with the unit.
 2. Preventative maintenance and service procedures and schedules.
 3. A parts list, edited to omit reference to items which do not apply to this installation.
 4. A list of any special tools required to service or maintain the components.
 5. Warranty, which clearly lists conditions to be maintained to keep warranty in effect and conditions that would affect the validity of the warranty.
- e. Supplemental Data: Prepare written text and/or special drawings to provide necessary information, where manufacturer's standard printed data is not available and information is necessary for a proper understanding of fenestration system maintenance or operation and maintenance of materials or systems installed, or where it is necessary to provide additional information to supplement data included in the manual or project documents.
- f. Divisions 23 and 26 Control Drawings: Include the control drawings for the piece of equipment and its components, including the sequence of operation. The security and CCs will provide this section. The drawings will be repeated in each contractor's O&M submittals.

- g. Specifications: This section is comprised of the component or system specification section copied and inserted complete with all addenda.
 - h. System Description: This section shall include the individual equipment portion of the overall system Design Documentation Narrative, if available. It will contain simplified professionally drawn single line system diagrams on 8 ½ x 11 or 11 x 17 sheets, unless the system's control drawing is deemed adequate by the CxP.
 - i. Preventive Maintenance Instructions: This section shall include condensed typewritten excerpts from the manufacturer's written instructions for weekly, monthly, quarterly, annual, etc. maintenance. The principle contractor responsible of the division shall prepare these summaries. For division 23, the HVAC MECHC with help from the equipment supplier shall prepare the mechanical summary. It shall be prepared for all items listed under condensed operating instructions (below), plus package, window or through the wall AC units and electric unitary heating equipment.
7. A/E's Contributions: The A/E's have special contributions to the O&M manuals as described in Yellow Book Section 019100.
8. Commissioning Record and Testing Data: There will be a separate manual dedicated to documenting the commissioning process which will include all certifications and testing data and some repeating of O&M data. Description of this manual is found in Yellow Book Section 019100 and shall be prepared by the CxP.
- D. The GC shall submit the O&M manuals for every piece of equipment and building enclosure system to the CxP for review 30 days prior to initial training.

END OF SECTION

017900 DEMONSTRATION AND TRAINING

1.01 Introduction

- A. In accordance with Yellow Book Section 019100 General Commissioning Requirements Georgia Institute of Technology (GT) requires their operation and maintenance (O&M) staff, assigned to the project shall be thoroughly trained in all aspects of the building enclosure, equipment and systems that serve the building. This section defines the required scope, responsibilities, format and stages to be employed by the design, construction, and commissioning teams needed to attain GT's Demonstration and Training requirements.
- B. Training shall be divided into three (3) stages:
 - 1. Training conducted during construction
 - 2. Initial training prior to final completion
 - 3. Final training approximately six (6) months after occupancy

1.02 Overview

- A. Training shall include a summary of building enclosure, mechanical, electrical, and plumbing systems, design, components and controls plus detailed instructions on the operation and maintenance of equipment, all to be presented by Design Professionals, Contractors, Manufacturers and/or equipment technical representatives as specified in this section.
- B. The General Contractor (GC) shall have the overall responsibility for training. The Mechanical, Electrical, Plumbing, Building Enclosure Contractors and other selected sub-contractors shall participate and be responsible for the training related to their respective disciplines and areas of work. For the requirements of this section, the word Contractor shall apply to all of the above referenced contractors. Appropriate and selected Manufacturers, Manufacturers Representatives, Factory Representatives, Vendors, Material Suppliers, etc. shall also participate and be responsible for the training related to their respective disciplines and areas of work. For the requirements of this section, the word Manufacturers/Vendor Group shall apply to all of the above referenced individuals.
- C. The Contractors and Manufacturers/Vendor Group shall be required to attend and participate in Owner's Staff Training, which, due to staged training events, may take a cumulative three (3) or more working days depending on the size and complexity of the building and O&M staff availability.

1.03 Prerequisites

- A. During the project the Contractors and Sub-contractors shall be in compliance with Yellow Book Section 019100 – General Commissioning Requirements, Section 017853 – Commissioning Closeout Procedures, and the project contract documents.

1.04 Submittals

- A. Training agendas developed by the CxP shall define the audience being trained and the general scope of the training including the specific levels of training the contractors and vendors shall provide.
 - 1. Levels can include:
 - a. Overview and purpose of components, equipment or assemblies and required interactions of the trainees, warranty requirements, etc.
 - b. Technical information regarding purpose, operation, and maintenance of the components, equipment or assemblies that are the focus of the training at an intermediate level expecting serious malfunctions will be addressed by factory representatives or installing contractor.
 - c. Technical information regarding purpose, troubleshooting, and maintenance of the components, equipment or assemblies that are the focus of the training at a very detailed level expecting that almost all operation, service, and repair will be provided by the trainees.
 - 2. Agenda defining the general subjects to be covered and the required duration of the training for each subject.
 - 3. Training methods to be included by the trainers and associated training material to be provided by the trainers to the trainees.
- B. Flowchart illustrating the training structure beginning with overview of all major systems, associated subsystems and components to the CxP and Owner for Owner approval.
- C. Completed training agendas, selected trainer and their qualifications to CxP and Owner for Owner approval.
- D. Copy of training material that will be provided to trainees by subject to CxP and Owner for Owner approval.
- E. Draft composite of professionally produced training videos to CxP and Owner for Owner approval.

2.01 Training Materials

- A. General: It shall be the Contractors responsibility to supply the following listed training materials for all Owner's Staff attending training sessions.
 - 1. A/V equipment as required for training
 - 2. Building Systems and Assemblies including but not limited to Fenestration, Roofing, and Equipment Installation, Operation and Maintenance (O&M) manuals
 - a. Manufacturer's current printed installation, operation, maintenance and service instructions for all building systems and assemblies.
 - b. Each trainee shall have ample access to each building system and assembly manual associated with the specific building system during training.

3. Equipment Operation and Maintenance (O&M) manuals
 - a. Manufacturer's current printed installation, operation, maintenance and service instructions for all commissioned equipment.
 - b. Each trainee shall have ample access to each Equipment O&M manual during training.
 4. Miscellaneous Training Material
 - a. Any printed training literature or other informational sheets as appropriate to cover emergency shutdown for non-technical and technical personnel, warranty requirements, and contractor's contact information.
 5. Training manuals: The standard O&M manuals for the facility systems and any special training manuals will be provided for each trainee
 - a. Training Manuals shall include detail descriptions of the subject matter for each session. The manuals will cover all control sequences and have a definitions section that fully describes all relevant words used in the manuals and in all software displays.
- C. Project O&M Manuals
1. Approved Project O&M Manuals shall be complete and made available at the Initial Training session
- D. CDs and/or DVDs of previously recorded on-site training.
- E. Equipment manufacturer's technician training videos.

3.01 Training Responsibilities

- A. General Contractor
1. The GC shall be responsible for training coordination, scheduling and ensuring completion of training in accordance with this section.
 2. The GC shall be responsible for the professional video filming, editing, and production, of both the initial and final systems training sessions. Videotaping shall be conducted by a professional video production company with a minimum of 4 years' experience. Each training as outlined in Table 1 shall be a separate segment which shall be reachable from the opening screen of the training video. The opening screen shall divide each trade (e.g. Building Enclosure, HVAC, electrical, etc.) as separate trainings segments which can be view in their entirety or by individual subsection comprising the subsystems, equipment, and components associated with more complex building systems. Submit one (1) copy to both the A/E and CxP for review and comment. Update/modify video training in response to comments received and re-submit for approval. Provide four (4) copies of the A/E and CxP approved DVD to the Owner. All video must be organized and separated by topic and each topic must be available within the home screen/chapter menu/scene selection menu on all DVDs.
 3. Manage the distribution and return of training agenda forms, provided by the CxP, documenting all training materials and instructors for each training session and return forms to CxP a minimum of four (4) weeks prior to scheduled date of training. Referenced forms are to be completed by Contractor(s), Design Professional and pertinent vendors.

- B. Building Enclosure, Roofing, & Fenestration Contractor, including all related sub-contractors shall:
 - 1. Work with the GC to coordinate, schedule and complete training in accordance with this section.
 - 2. Provide training including, but not limited to, the following topics:
 - a. Overview of system, assembly, and components that provides a general understanding of how the systems, their elements interface with other systems, general assembly, and as a composite keep moisture and air from entering the building's dry zone.
 - b. Critical maintenance requirements needed to maintain the performance of the system, assembly, or specific components (sealants, weeps, flashing, etc.).
 - c. Description and strategies to resolve typical issues encountered by owners with like installed enclosure system, assemblies and components.
 - d. Ensure that the training provided provides detailed trouble-shooting and maintenance guidance at the component level.
 - e. Provide the General Contractor with completed training agenda forms provided by CxP.
- C. Mechanical, Plumbing and Electrical Contractor including all related sub-contractor
 - 1. Provide the CxP with a training plan two (2) weeks before the planned training.
 - 2. Provide designated Owner's personnel with comprehensive orientation and training in the understanding of the mechanical and electrical systems and the operation and maintenance of each piece of mechanical and electrical hardware including, but not limited to, panel boards, switchboards, transformers, lighting controls, HVAC systems and equipment, etc.
 - 3. Start training with classroom sessions followed by hands-on training on each piece of mechanical and electrical hardware, which shall illustrate the various nodes of operation, including startup, shutdown, etc.
 - 4. Ensure that during any demonstration, should the system fail to perform in accordance with the requirements of the O&M manual or sequence of operation, the system will be repaired or adjusted as necessary and the demonstration repeated.
 - 5. Ensure that the appropriate trade or manufacturer's representative shall provide the instructions on each major piece of mechanical and electrical hardware. Practical building operating expertise as well as in-depth knowledge of all modes of operation of the specific piece of hardware is required. More than one party may be required to execute the training
 - 6. Fully explain and demonstrate the operation, function and overrides of any local packaged controls not controlled by the building automation system.
 - 7. Furnish training videos used by equipment vendors/manufacturers to train their representatives
- D. Manufacturers, Manufacturer's Representatives, Factory Representatives, Vendors, Material Suppliers, etc.

1. Provide the respective MECHC and ELECC with a training plan three (3) weeks before the planned training.
 2. The Manufacturer's Group shall provide the designated Owner's personnel training by qualified and knowledgeable (on the system and its use in the facility (representatives who shall present overviews of equipment, controls, function, operation and maintenance, normal use, etc. and shall be prepared to respond to questions and concerns from GT O&M staff and A/E representatives on their respective systems.
 3. Provide O&M literature
- E. Controls Contractor
1. Provide the General Contractor with completed training agenda forms from the CxP.
 2. Provide the designated Owner's personnel training on the control system including power transfer, monitoring condition, HVAC control, BAS, etc. The intent is to clearly and completely instruct the Owner on all the capabilities of the electrical, fire, security, and HVAC control systems.
 3. Attend sessions other than the controls training, as requested, to discuss and explain the interaction of the control system as it relates to operation of the equipment being discussed.
- F. Testing and Balancing Contractor
1. Go over the final TAB report, explaining the layout and meanings of each data type.
 - a. Discuss any outstanding deficient items in control, ducting or design that may affect the proper delivery of air or water
 - b. Identify and discuss any terminal units, duct runs, diffusers, coils, fans and pumps that are close to or are not meeting their design capacity.
 - c. Discuss any temporary settings and steps to finalize them for any areas that are not finished.
 - d. Provide any salient information that may be useful for facility operation relative to TAB.
- G. Fire Suppression and Alarm Contractors.
1. Provide the General Contractor with completed training agenda forms from the CxP.
 2. Fully explain the operation, function and overrides of fire panel and fire protection systems including detailed instructions on emergency shut down procedures.
- H. Electronic Security Contractors (CCTV / Card Access).
1. Provide the General Contractor with completed training agenda forms from the CxP.
 2. Fully explain the operation, function and overrides of closed circuit television monitoring and card access systems including detailed instructions on emergency operation procedures as specified in the project contract documents.

3. Training format and duration requirements specified in the project contract documents and those described within this section. The CxP shall attend and document that training for all systems has been accomplished per the aforementioned division 28 sections.
- I. Design Professionals
 1. Complete the appropriate portion of the training forms, provided by the CxP, and distributed by the GC and return forms to GC a minimum of three (3) weeks prior to the schedule date of training.
 2. Provide the designated Owner’s personnel training including an overview and outline of the design intent of each system.
 3. Observe and comment as appropriate at training sessions.

3.02 Training Format

- A. The training sessions shall follow the outline in the Table of Contents of the O&M manual and illustrate, whenever possible, the use of the O&M manuals for reference.
- B. The format and training agenda will be provided by the CxP and generally follows The Commissioning Process, ASHRAE Standard 202 - 2013. In general, the following training methods shall be used:
 1. Walk-through: On site tours of the facility designed to familiarize the trainee with the location of equipment and the inter relationship with support systems, power, controls, shut-off, etc.
 2. Hands-on Instruction: At selected pieces of equipment or systems with hands-on demonstration and instruction of the operation, maintenance and service of that equipment.
 3. Classroom instruction: Typical classroom/lecture setting.
 - a. Manufacturer training video presentation of equipment and system
 - b. Demonstrate the use of the Manufacturer’s O&M manuals and illustrate where the verbal training information is found within the manual.
 - c. Distribution and presentation of additional written training information, handouts, etc.
 - d. Classroom lecture/sessions shall include the use of computer presentations, still pictures and video/audio-taped material as appropriate
 - e. Classroom session shall include discussion of control drawing schematic and sequence of operation
 - f. Classroom hands-on demonstration of equipment including testing and service equipment.
 4. The trainings will be tailored to the needs and skill level of the trainees. This includes providing an overview of the system down to the most technical information.
 5. During any demonstration, should the system fail to perform in accordance with the requirements of the O&M manual or sequence of operation, the system will be repaired or adjusted as necessary and the demonstration repeated.

3.03 Training Requirements

- A. Training shall include but is not limited to the following:
1. Hands-on training
 - a. MEP: shall include start-up, operation in all modes possible, including manual, shut- down and any emergency procedures and preventative maintenance for all pieces of equipment and controls including BAS. Include the location of valves, mechanical and electrical infrastructures and other operational components. Provide comprehensive training of the pertinent O&M requirements.
 - b. Enclosure: shall include proper function and operation of components within the system (Fenestration, Roofing, etc.), installation of typical replacement parts, typical cleaning procedures.
 - c. Electronic Security: shall include start-up/shut-down and operation in all modes including loss of power, various failure modes, and emergency procedures defined in the OPR or CFR, and preventative maintenance for all pieces of equipment and controls. Contractor will show O&M staff the physical location of monitoring devices, card readers, data collection systems, and other operational components as part of a comprehensive training of the O&M staff.
 2. Classroom training
 - a. A review of the written O&M instructions emphasizing safe and proper operation requirement, service, maintenance, preventative maintenance, special tools needed and spare parts inventory suggestions (sources).
 - b. General purpose of systems or equipment (design intent).
 - c. Review of control drawings and schematic (have copies for attendees).
 - d. Start-up, loading, normal operation, unloading, shutdown, occupied operation, seasonal changeover, emergency procedures, etc. as applicable
 - e. Integral controls (packaged): programming, troubleshooting, alarms, manual operation
 - f. Building automation controls (BAS): programming, troubleshooting, alarms, manual operation
 - g. Interactions with other systems, operation during power outage and fire
 - h. Discussion of relevant health/safety issues and concerns and safety features
 - i. Energy conserving operation and strategies
 - j. Discussion of warranties and guarantees
 - k. Common troubleshooting problems and solutions, control system warnings and error messages, including using the control system for diagnostics, as applicable
 - l. Discussion of special requirements of tenants for equipment functions as applicable.

- m. Explanatory information included in the O&M manuals and the location of all plans and manuals in the facility
 - n. Discussion of any peculiarities of equipment installation or operation
3. Question and answer period

3.04 Staged Progressive Training Sessions

- A. Walk-through & Familiarization: During construction, the contractors will provide a partial walk-through with the owner's personnel to familiarize them with the locations of equipment, valves, junction boxes, piping, ductwork, etc. before they are covered with interior finishes
- 1. Format / Completed training agendas must be submitted to the CxP 30 days prior to the scheduled training date.
- B. Initial Systems Training: Initial training will be held on-site and will occur prior to final completion. This initial training will discuss and explain an overview of all equipment and systems specified in the project contract documents. Detailed Initial System Training shall be provided by electrical, mechanical, lighting, fire alarm, building automation controls, security (CCTV and Card Access) and other relevant contractors involved with the project. Training sessions will include classroom or on-site lectures as well as hands-on training and demonstration of equipment and systems. Upon completion, each trainee, using appropriate documentation, should be able to perform operations and describe hardware and functionality of the system. The training will include instruction on:
- 1. Specific hardware configuration of installed systems in the building and specific instruction of operating the installed system, including HVAC systems, lighting controls and any interface with security and communication systems.
 - 2. Security levels, alarms, system start-up, shut-down, power outage and restart routines, changing setpoints and alarms and other typically changed parameters, overrides, freeze protection, manual operation of equipment, optional control strategies that can be considered, energy savings strategies and setpoints that is change will adversely affect energy consumption, energy accounting, procedures for obtaining vendor assistance, etc.
 - 3. All trending and monitoring features (values, change of state, totalization, etc.) including setting up, executing, downloading, viewing both tabular and graphically and printing trends shall be taught to students. Trainees will actually set-up trends in the presence of the trainer. The following will be discussed:
 - a. Every screen
 - b. Use of keypad or plug-in laptop computer at the zone level
 - c. Use of remote access to the system via phone lines or networks.
 - d. Graphics generation

4. The initial training shall consist of:
 - a. Training on interior lighting controls and all other electrical and life safety equipment system (see OPR/CFR project contract documents for minimum training period).
 - b. Training on HVAC control system/BAS and other HVAC/mechanical equipment and systems (see OPR/CFR project contract documents for minimum training period).
 - c. Training on CCTV and card access systems (see OPR/CFR project contract documents for minimum training period).
 5. Format / Completed training agendas must be submitted to the CxP 30 days prior to the scheduled training date.
- C. Final Training: Final training will be conducted on-site six months after occupancy and will discuss the overall/general functions of all mechanical, electrical, security, and fire protection systems. The session(s) will also be structured to address specific topics that trainees need to discuss and to answer questions concerning operation of the system.
1. Format / Completed training agendas must be submitted to the CxP 30 days prior to the scheduled training date.

END OF SECTION

018113 Sustainable Design Requirements

1.01 GENERAL: SUSTAINABILITY AND STEWARDSHIP IN DESIGN AND OPERATION

- A. Georgia Institute of Technology (GT) commitment to a comprehensive 'green' building program and our emergence as a national leader in this growing trend reflects our intention to develop an environmentally sustainable campus. Major institutions simply must take the lead in responsible planning to address the challenges of declining air quality, depletion of natural resources and traffic congestion.
- B. GT utilizes The State of Georgia Energy Efficiency and Sustainable Construction Standards for State Buildings (also known as Peach Green Building Rating System) as a benchmark to gauge their efforts in energy and water efficiency, and use of Georgia-based building materials. GT utilizes various guiding principle in the development of all the Institution's construction and renovation projects defined within the Yellow Book. GT evaluates the environmental sustainability of building design, construction and operation, and focuses on building site selection and erosion control, water efficiency, energy and atmosphere, materials and resources, and indoor environmental quality. Sustainability and stewardship practiced by GT makes good business sense. By building 'green' we are reducing long-term operating costs for the university and our impact and footprint on the environment around us. GT's green building program is one of the Institution's many environmental initiatives, including an extensive alternative transportation program, the creation and continued development of a core walking campus, and a nationally recognized recycling program.
- C. All new building projects and major renovations are required to be designed to provide easily- accessible, dedicated areas for the collection and storage of recycled materials generated from the building and their removal to the central recycling center. At a minimum, these materials must include paper, corrugated cardboard, glass, plastics, and metals.

2.01 SUSTAINABILITY AND STEWARDSHIP IMPLEMENTATION PROCESS

- A. GT wishes to follow the Peach Green Building Rating System as a benchmarking tool for all new buildings and major renovations planned at GT. GT feels that in lieu of expending funds for extensive documentation that those funds be used to implement Sustainable practices and good stewardship through the requirements contained within the Yellow Book.
- B. The Project Architect is required to implement the project under the Peach Green Building Rating System and Yellow Book requirements. Projects are required to meet the mandatory requirements of Peach and achieve a minimum of 31 points or two peaches. This requirement may be waived on a case by case basis by Design and Construction for small capital projects such as minor renovation building.

3.01 DESIGN REQUIREMENTS

- A. Provide an easily accessible dedicated area for the collection and storage for recycling for the entire building.
- B. Provide products with recycled content such that the sum of post-consumer recycled content plus one-half of the post-industrial recycled content constitutes at least 10 percent of the total value of all products installed, except mechanical and electrical components.

- C. Some materials that can contain levels of recycled content that can help achieve the recycled content goal include structural steel, rebar, carpet /carpet tile, gypsum board, ceiling tiles, concrete/CMU, and aluminum products.
- D. Provide materials amounting to a minimum of 70 percent of the total value of all materials (excluding plumbing, HVAC, electrical, elevators, and other equipment) that have been extracted, harvested, or recovered, as well as manufactured, within The State of Georgia. GT encourages projects to purchase the remaining materials with a radius of 500 miles from the project site. Some products that can help achieve Peach Green Building Rating System Regional Materials credits include wood construction materials, tile, and carpet/carpet tile, landscaping, concrete/CMU/precast, and glass/windows/storefront.
- E. Demonstrate through computer simulations that 75% or more of all regularly occupied spaces achieve daylight illuminance levels of a minimum 25 and a maximum of 500 foot-candles in clear sky conditions on 9/21 at 9:00 am and 3:00 pm.
- F. In an effort to obtain the actual performance characteristics and abide by the sustainability goals of GT designers shall implement enhanced sub-metering on all new and renovated buildings. Enhanced sub-metering design shall include but not limited to the trending and logging of all principle electrical (lighting, plug and mechanical) and mechanical (utilities: steam and chilled water) building loads. Enhanced sub-metering design shall adhere to sections 230519: J through L and 262713: 3.01 through 6.01. Scope and limitations of the enhanced sub-metering design will be at GT’s discretion.
- G. In accordance with section E, a detailed energy simulation, abiding by section 230002: 8.01, shall be developed to show the as-designed construction of the new or renovated building projects. The proposed design shall indicate the predicted Energy Use Intensity (EUI) the design will be delivering when the building is occupied. Designers shall provide Life Cycle Cost analysis for energy and water efficiency as required in Yellow Book Section 010001 “General Requirements.” Designers are responsible for accurate estimates of expected operation, control and use as specified by Georgia Tech Facilities departments. Further comparisons of said model will be used to evaluate actual performance and performance over a monitored period as described in the measurement and verification report.

4.01 Sustainable Design and Construction Submittal Form

Identification Project Name _____

Project Number _____

Architect _____

Product Name (name, model #, etc) _____

Manufacturer _____

Supplier/Sub _____

Applicable Specification Section Number(s) _____

Cost of product _____

This form applies the amount of Recycled Content and Regional Materials in the project.

Percentage of Post-Consumer Recycled Content _____

Percentage of Post-Industrial Recycled Content _____

Regional Materials

The following percentages of this product were processed in the locations indicated. (Indicate N/A in the first column if the process is not applicable.)

Product/Material	Manufacturing Location	Harvesting Location	Percentage Manufactured or Harvested	Retail Value

Calculations

Equation 1:
*Percentage of Georgia Materials= Total Cost of Georgia Materials (\$)/Total Cost of Materials (\$)*100*

END OF SECTION

018800 - OTHER REQUIREMENTS

1.01 General

- A. Trucks and service vehicles associated with any building project on the Georgia Tech campus must turn off their engines while making deliveries. The General Contractor must place “No Idle Zone” signs in the areas where service and delivery vehicles frequently operate while on campus for the duration of the Project. The new policy excludes safety and emergency vehicles, electric vehicles, and trailer engines used solely to control freight temperatures. The “No Idle” policy is created to reduce wasted fuel; improve air quality on campus and in the region; and to protect campus workers, students, and visitors from potentially harmful emissions.
- B. Dead Week and Finals Week – No construction activities will be permitted during these (2) week long periods without prior Approval from Facilities Design and Construction.

END OF SECTION

019100 COMMISSIONING GENERAL REQUIREMENTS

1.01 Description

- A. Commissioning is a mandatory requirement of Department of Community Affairs (DCA), Georgia State Finance and Investment Commission (GSFIC), and Georgia Institute of Technology (GT) for all new construction and/or alternate delivery methods such as CM at Risk, Design/Build or other developed project delivery methods. The ownership of the project or finance method, including leasing/renting does not offset, sidestep or allow for deletion of this Commissioning requirement. The basic purpose of commissioning is "to provide documented confirmation that building systems and assemblies function in compliance with criteria set forth in the Owner's Project Requirements (OPR) for new projects and Current Facility Requirements (CFR) for modifications to existing buildings". All projects equal or greater to ten thousand GSF or having budgets of one million dollars or more are considered major renovations and require commissioning in accordance with the Yellow Book. The need to commission smaller renovation projects shall be evaluated by GT based on the complexity of the project and the systems within the project scope.
- B. The Commissioning Team consists of the Owner (GT, and DCA or GSFIC if involved with the project), Commissioning Provider (CxP), and Design and Construction team members. The Owner is responsible to see that the OPR or CFR are developed prior to the start of the design of the project.
- C. The Design Team is responsible for integrating GT goals and objectives documented in the OPR or CFR and the commissioning requirements provided by the CxP into the Project Documents, and providing clear direction for the Construction Team to follow. The design team shall attend the OPR/CFR development workshop to collect information preferable prior to the start of architectural programming. The design team shall provide a Basis of Design documents at each design submission to GT, other identified stakeholders and The CxP. Each design discipline shall provide:
1. Narratives describing the systems, cut sheets of products, components, equipment used as the basis of design
 2. Copies of all studies conducted as part of developing a design solution relevant to the stage of design submission.
 3. All calculations performed in development of the design solution, selection of products, components, and equipment.
 4. All assumptions used in selection of products, components, and equipment.
- D. The Commissioning Provider (CxP) shall, at a minimum, commission the following systems; mechanical systems (heating, ventilating, air conditioning, and refrigeration equipment and controls, heat recovery and renewable energy systems, laboratory systems, test and balance verification), electrical systems (lighting and daylighting controls and renewable energy systems), and plumbing systems (plumbing fixtures, landscaping irrigation controls, potable water pump stations, sump pumps, domestic hot water systems, rainwater collection systems, and onsite waste water treatment systems). Other systems that may be considered in the commissioning process include the building enclosure, dangerous gas monitoring; normal, standby and emergency power systems, voice data, fire alarm; metering and submetering of utilities serving the building, mechanical conveyances. The commissioning authority shall evaluate the installation and performance of all commissioned systems to

- ensure that the building and systems perform in accordance with the Owner's Project Requirements (OPR) for new construction and major renovations or the Current Facility Requirements (CFR) for existing buildings not being substantially renovated.
1. The Commissioning Process is a quality-focused process for enhancing the delivery of a project. The process focuses upon evaluating verifying and documenting that all of the commissioned systems and assemblies are planned, designed, installed, tested, operated, and maintained to meet the Owner's Project Requirements. GT expects CxP to identify opportunities to improve building performance throughout the commissioning process and provide the data needed for GT to make informed decisions.
 2. The Commissioning Process assumes that owners, programmers, designers, contractors, and operations and maintenance entities are fully accountable for the quality of their work. The Commissioning Team uses methods and tools to evaluate that the project is achieving the Owner's Project Requirements throughout the delivery of the project.
- E. The Commissioning Process shall begin in the pre-design phase and, if directed by GT, conduct the OPR/CRF workshop and document the OPR or CFR results setting the foundation for integrated design and project delivery. The commissioning shall continue through construction, acceptance and the warranty period.
- F. Circumstances may cause owners to adopt the Commissioning Process during the Design or Construction Phase of a project, such later implementation must capture the information that would have been developed had the Commissioning Process begun at project inception.
- G. The commissioning process shall:
1. Evaluate that building systems and assemblies included in the commissioning scope meet the Owner's objectives and criteria documented in the OPR or CFR.
 2. Assemble documentation from the project team that provides the Owner's operational staff with the documentation required to operate, maintain and facilitate future modifications in accordance with the OPR.
 3. Conduct, direct, witness, and document testing for the purpose of evaluating building systems and assemblies perform in accordance with the OPR or CFR.
 4. Develop training and demonstration requirements based on OPR or CFR, schedule and witness required training was provided and document who was trained.
- H. The commissioning process does not take away from or reduce the responsibility of the system designers or installing contractors to provide a finished and fully functioning product. Based on the Commissioning Scope, CxP shall develop commission specifications including general requirements defined in Division O I and specific commissioning requirements for each Division contained in the commissioning scope in accordance with CSI 2004 format.

2.01 Coordination

A. Commissioning Team

Abbreviation	Subject	Abbreviation	Subject
A/E	Architect/Engineer (Design Professional Team) One or a multiple professional firms that provide the design disciplines required for this project	CxP	Commissioning Provider
GC	General Contractor	ELECC	Electrical Contractor
MECHC	Mechanical Contractor	PLMBC	Plumbing Contractor
TABC	Testing and Balancing Contractor	C/IC	Controls and Instrumentation Contractor
BIC	Building Insulation Contractor	CFMFC	Cold Formed Metal Framing Contractor
CONCC	Cast in Place Concrete Contractor	CWC	Curtain Wall Contractor
DPC	Dampproofing Contractor	D/WC	Door and Window Contractor
EIFSC	Exterior Insulation Finish System Contractor	EMFC	Exterior Metal Finishes Contractor
FSMC	Flashing and Sheet Metal Contractor	GLC	Glazing Contractor
GYPC	Gypsum Wall Systems Contractor	MSC	Masonry Contractor
MDC	Metal Decking Contractor	PCONC	Precast Concrete Contractor
RFC	Roofing Contractor	SC	Sealant Contractor
STNC	Stone (and cast stone) Contractor	STC	Stucco System Contractor
WPC	Waterproofing Contractor	ETC	Electronic Technology Contractors (Security, IT/Noise, etc.)
Const-CK	Construction Check List	CxP-PM	Commissioning Provider Project Manager
HVAC	Heating, Ventilation and Air Conditioning	O&M	Operations & Maintenance
O-REP	Owners Representative	TP	Test Procedure
GC-SUPER	General Contractor's Field Superintendent	GC-PM	General Contractors Project Manager

QPR	Owner's Project Requirements (and Performance Requirements)	CFR	Current Facility Requirements (Performance Requirements)
-----	---	-----	--

- B. Management. The CxP is hired by the Owner directly as part of the project team and is an integral part of the design/delivery team. In certain contact delivery methods, the ownership of the commissioning contact will be transferred to the project delivery team to ensure continuity. The CxP directs and coordinates the commissioning activities and the reports to the GS FIC and GT project manager. All members work to get her to fulfill their contracted responsibilities and meet the objectives of the OPR or CFR and Contract Documents. The CxP's responsibilities are the same regardless of who hired the CxP. All of the CxP identified issues .log shall be integrated in to the projects official record maintained by the project team. These reports are instruments for the owner/architect/project manager to demand contactor corrections.

3.01 Commissioning Process

- A. The Commissioning Process is a quality-focused process for enhancing the delivery of a project. The process focuses upon evaluating verifying and documenting that all of the commissioned systems and assemblies are planned, designed, installed, tested, operated, and maintained to meet the OPR or CFR.
- B. At the initiation of the Commissioning Process, the Owner is responsible for determining the scope of the Cx Plan (that is, the systems and assemblies to be included), selecting the Cx Process team leader, selecting the Cx process team for the project, incorporating Cx activities into project team roles and responsibilities, and the establishment of Cx budget. The selected CxP directs the commissioning process and shall be an objective advocate of the Owner.
- C. The Owner shall provide direction, reviews and acceptance as required throughout the project and the Cx process.
- D. The selected Commissioning Team (CxT) shall provide the following if included in the commiss10nmg scope:
 - 1. Pre-design Phase:
 - a. CxP shall assist the Owner with the development of the Owner's Project Requirements or Current Facility requirements. The Owner shall ensure the development of the project's OPR or CFR. The OPR or CFR shall include at a minimum:
 - 1. Facility objectives, size, location, user requirements, and owner directives.
 - 2. Environmental, sustainability, and efficiency goals and benchmarks (EUI minimum target, percentage better than ASHRAE 90.1, etc.).
 - 3. Indoor environment requirements, including temperature, humidity, and ventilation.
 - 4. Space usage, occupancy, and operation schedules.
 - 5. Commissioning process scope and requirements, listing of equipment, systems and assemblies requiring commissioning.

6. Equipment, systems and assembly requirements, expectations, and warranty provisions.
 7. Maintainability, access, and operational performance requirements.
 8. Installation evaluation and testing requirements.
 9. Project documentation and Systems Manual requirements and formats.
 10. Training requirements for owner's operation and maintenance personnel and occupants.
 11. Applicable codes and standards in addition to local building codes.
 12. Project schedules.
 13. Special project requirements.
 14. The content, organization, and milestones of BOD submittals for the design and construction process.
 15. The number, format and scheduling of design and submittal reviews.
 16. Sampling procedures, if permitted, for all reviews, evaluations and testing.
 17. Commissioning Progress Report formats and distributed intervals.
- b. During the Pre-Design Phase the Design Team shall participate in the Owner's Project (OPR) Workshop (Typically a 4 hour event) and conduct a review of the OPR developed by the CxP and provide comments to Owner and CxP. Key participants shall include GT stakeholders including end user groups, CPSM and Facilities Management teams. Design Team participation prior to development of architectural program can benefit the design team and reduce some of the programming effort.
 - c. Utilizing the OPR or CFR the CxP shall develop a design phase Cx Plan that includes, commissioning scope, overview of the commissioning process during design, roles and responsibilities of the design phase project team, communication protocols, and tentative schedule of commissioning activities.
2. Design Phase:
 - a. The project architect/engineer shall include the commissioning authority as part of the project team and shall consider all commissioning review comments, technical memos, specifications, submittal review reports, field reports, issues and benefit log, and commissioning progress reports when developing directions to the construction team. All commissioning documents sent to the Owner's team with copies to the design team, and construction team only during the construction period.

- b. Design Team participates in the commissioning process in accordance with the requirements contained in the Yellow Book and the Owner approved design and construction phases commissioning plan, which shall contain at a minimum the following:
 1. Development of the Basis of Design: As the design progresses the design team shall issue Basis of Design (BOD) documentation at each design submission. The BOD is a written document that shall provide detailed information on the design team approach to meeting the OPR. The BOD provides the Owner with a better understanding of design issues, and information GT requires to make informed decisions. The BOD shall be developed by the design team in accordance with the OPR. The BOD shall be updated and expanded during design and construction as the project evolves. The function of the BOD shall be to:
 - a. Describe in detail the design team's technical approach to each of the Owner's requirements including providing copies of cut sheets of materials, components, assemblies and equipment the design is based on. Associated studies and analysis used by the design team to make design decisions including but not limited to material compatibility, daylighting models, energy and water efficiency simulation models or calculations, assumed population density and activity levels by space type, interior lighting levels, exterior lighting photometric, etc.
 2. If during the Design Phase the Owner requests the CxP to perform a commissioning design review the design team shall respond to comments in writing and participate in a project team meeting to review select comments requiring discussion. Project team meeting to review commissioning comments shall follow receipt of designer responses to Commissioning Team (CxT) comments. Each discipline will participate for their section of commissioning comments, except for the lead architect, who as the design team lead, will be present during all design related discussions. Each design discipline included in the commissioning scope shall allow one hour per design submission for the project team commissioning design review meeting to focus specifically on commissioning comments related to their discipline. GSFIC and GT designated representatives shall review the Cx Process design review comments, participate in an issue resolution process, and provide direction to the team when needed to meet the OPR.
 3. The CxP shall, through GT and GSFIC project manager schedule the collaborative design discussion of commissioning comments, provide a schedule for each discipline's participation in consensus with Architect Design Manager.

4. At the Design Development design submission the design team shall issue a preliminary project specifications that represent systems and assemblies contained in the basis of design. A minimum of one weeks prior to the construction document submission by the design team the CxP shall submit draft commissioning specifications to the design architect for inclusion in the mid Construction Document (CD) submittal.
 - a. The CxP shall submit specifications in compliance with the OPR and Yellow Book requirements. At a minimum the CxP shall submit the following specifications and commissioning documents to the design team and owner for review, comment, and approval:
 1. Section 01 33 01 Commissioning Submittal Procedures
 2. Section 01 78 01 Commissioning Closeout Procedures
 3. Section 01 79 00 Demonstration and Training
 4. Section 01 91 00 Commissioning Requirements
 5. Section 22 80 00 Commissioning of Plumbing Systems
 6. Section 23 80 00 Commissioning of HVAC Systems
 7. Section 26 80 00 Commissioning of Electrical systems
 8. Draft Construction Phase Commissioning Plan, Sample Construction Checklists and Test Procedures (See Cx Plan content requirements below).
 - b. The CxP shall submit final commissioning specifications, updated draft construction phase commissioning plan, project specific draft commissioning construction checklists and test procedures a minimum of one week prior to 100% Construction Document submission by the design team.
5. Construction Phase:
 - a. Design and construction teams participates in the commissioning process in accordance with the requirements contained in the Yellow Book and the Owner approved construction phase commissioning plan (Cx Plan).
 - b. The Cx Plan is developed by the CxT and approved by the Owner. The Cx Plan shall contain at a minimum the following:
 1. Overview of the Cx Process developed specifically for the project.
 2. Roles and responsibilities for the Cx Team throughout the project.
 3. Documentation of general communication channels including the distribution of the Cx Plan and subsequent commissioning reports during the construction process.
 4. Detailed description of Cx Process activities and a schedule of activities.
 5. General description of Cx Process activities that will occur during Construction, and Occupancy and Operations.

6. Summary of format that will be used by project team in providing Cx Process documentation, including Systems Manual and Training Plans.
 7. Draft commissioning evaluation checklists and testing forms, issues and resolution log form with instructions on how it is used, and Cx Progress Reports that will be used during the project to communicate and track critical Cx Process information.
 8. List of project commissioned systems and assemblies and summary of evaluation procedures contained in the specifications including Draft Commissioning Construction Checklists and Draft Commissioning Test Procedures.
- c. The CxP shall conduct a commissioning kick-off and scoping meeting with the Commissioning team (including relevant design and construction team members) at the beginning of the project to explain Cx procedures, coordinate commissioning activities including review of construction submittal procedures, project team deliverables, and schedule of commissioning activities. Based on project team input the Cx Plan will be updated, submitted to owner for approval, and distributed to the project team.
 - d. Commissioning activity coordination and scheduling shall occur throughout the project including reviewing issues at OAC and GC progress meetings, preconstruction meetings contained, and issues resolution meetings.
 - e. Submittal Review is performed concurrent with the design team. CxT comments are provided to the design team for their consideration prior to responding to contractors. After designer approval of the construction submittals for commissioned systems and assemblies the CxT will finalize the Commissioning Construction Checklists and Test procedures and issue the documents to the Construction team.
 1. Project-specific Construction Checklists and Cx testing procedures shall be established for review by Owner and appropriate team members.
 2. The test procedures shall list the entities responsible for executing each of the tests.
 3. Whenever a test data result is required for a specific system or assembly, there shall be an item in the associated Construction Checklist for the test data to be submitted to the CxP.
 - f. Evaluation of the systems and assemblies by the Cx team shall include the following:
 1. Vital information on the system, assembly, equipment or materials being supplied. Information shall detail what system, assembly, equipment/material was specified and submitted.
 2. What was actually delivered on the site shall be documented and verified. The condition of the equipment at the time it is delivered at the site and prior to its installation.

3. Proper installation of the systems and assemblies. Evaluation shall focus on the physical installation of the systems and assemblies, on their ability to meet the contract documents requirements, and on accessibility for Cx, testing, and maintenance operations.
4. Successful Cx testing results of systems and assemblies.
- g. Executing Test Procedures
 1. Once Construction Checklists and test procedures are established, the responsible entities shall execute relevant test protocols and repeat testing as necessary until equipment, systems, or assemblies being tested pass all tests.
 2. The CxP directs, witnesses, and documents the tests conducted by the Cx Team as required by the Cx Plan.
 3. Completed test reports shall be submitted to the project team for review.
 4. Any commissioned system or assembly that fails to meet requirements and that cannot be resolved in a timely manner shall be given an issue number and recorded in the Issue and Resolution Log to facilitate follow up.
 5. All checklists and test procedure results shall be compiled into the Final Commissioning Report.
6. Post Occupancy Operation
 - a. Post occupancy operation commissioning, including delayed and seasonal testing and warranty issues, shall be provided to deliver buildings and construction projects that meet the Owner's needs, prior to the time of warranty completion. The Post Occupancy Operations Activities of the Commissioning Process begin at substantial completion.
 1. The Cx Process activities shall continue through the end of the contractual warranty period.
 2. The seasonal, delayed, and incomplete testing of facility systems and assemblies shall be completed. The CxP shall determine when the Cx testing shall be performed based on weather conditions, load conditions, or occupant interactions that are required to complete the activities for all systems and assemblies being commissioned.
 3. The general contractor shall coordinate contractor call-backs to resolve issues identified during the Cx Process and provide written documentation to the CxP that the issues have been resolved and/or the Owner has accepted the final conditions.
 4. Additional training shall be performed during the Post Occupancy and Operations activities in accordance with the Training and Cx Plans.
 5. During the Post Occupancy Operations activities, the operation, maintenance, and modification of the facility systems and assemblies, and their associated documentation, shall be evaluated to comply with the updated OPR and BOD.

- 6. By the conclusion of the Post Occupancy Operation commissioning activities, the Systems Manual, testing documentation, issue and Resolution Logs, training report, and a final Cx Report shall be updated and submitted for acceptance.
- E. Construction Phase Commissioning Plan. The Construction Phase Commissioning Plan, provided as part of the bid documents, is binding on the Contractor. The commissioning plan provides guidance in the execution of the commissioning process. Just after the initial commissioning scoping meeting the CxP will update the plan which is then considered the final plan, though it will continue to evolve and expand as the project progresses. The Design criteria will take precedence over the Commissioning Plan.

4.01 Related Work

- D. Specific commissioning requirements are given in the following sections of these design criteria. All of the following sections apply to the Work of this section.

01 33 01 Commissioning Submittal Procedures	Alerts all parties that additional detail in submittals is required for commissioning and directs to Division O1
01 78 01 Commissioning Close-out Procedures	Alerts all parties that additional detail in submittals is required to meet commissioning documentation requirements and directs to Division 01
01 79 00 Demonstration and Training	Alerts all parties of training requirements for each building system and assembly to be provided by the construction team-and directs to Division O1.
01 91 00 Commissioning Requirements	Alerts all parties of commissioning requirements and associated roles and responsibilities.
07 08 00 Commissioning of Thermal and Moisture Protection	Alerts building enclosure contractors of Cx requirements in Division 07
08 08 00 Commissioning of Openings and Fenestration Systems	Alerts building enclosure contractors of Cx requirements in Division 08
13 08 00 Commissioning of Special Construction	Alerts special construction contractors of Cx requirements in Division 13
22 08 00 Commissioning of Plumbing Systems	Alerts Plumbing Contractor and their Subcontractors of Cx requirements in Division 22
23 08 00 Commissioning of HVAC Systems	Alerts HVAC Contractor and their Subcontractors of Cx requirements in Division 23
26 08 00 Commissioning of Electrical Systems	Alerts Electrical Contractor and their Subcontractors of Cx requirements in Division 26
33 08 00 Commissioning of Utilities	Alerts Utility Infrastructure Contractors and their Subcontractors of Cx requirements in Division 33

5.01 Responsibilities

- A. The responsibilities of select parties in the commissioning process are summarized in the following articles of this Section 5.01 Responsibilities.
- B. The Contractor is not responsible for providing the services of the Engineer, Designer and CxP. Their responsibilities are listed here to clarify the commissioning process. Responsibilities of Contractor have been broken up by discipline to increase clarity only and are not intended to specify the manner which Contractor shall follow to meet these requirements.
- C. The responsibilities of the Designer, Engineer and CxP shown here are not intended to alter their contractual responsibilities to the Owner. These responsibilities have been established by separate contracts of the said parties with the Owner. Their responsibilities are listed here only to clarify the commissioning process.
- D. All Participating Parties
 - 1. Follow the Commissioning Plan.
 - 2. Attend commissioning scoping meeting and additional meetings, as necessary.
- E. Architect (of A/E)
 - 5. Design Phase
 - a. Follow OPR or CFR, and GT approved commissioning plans for design and construction. See Section 3.01 for general expected participation in the commissioning process.
 - 6. Construction and Acceptance Phase
 - a. Does not manage the CxP's contract; said contract managed directly by owner.
 - b. Attend and participate in the Commissioning Kickoff and Scoping meetings and selected commissioning team meetings.
 - c. Perform normal submittal review, construction observation, as-built drawing preparation, O&M manual, etc., as contracted.
 - d. Complete the Basis of Design (BOD) form furnished by the CxP and provide the design narrative documentation requested as a part of the BOD.
 - e. Coordinate resolution of issues identified during the (3) three Design Reviews (DD, SD and CD phases of the drawings and specifications) in according with the contract documents.
 - f. Coordinate resolution of system deficiencies identified during commissioning, according to the contract documents.
 - g. Prepare and submit record drawings and documentation for inclusion in the O&M manuals. Review and accept the O&M manuals.
 - 7. Warranty Phase
 - a. Coordinate resolution of design non-conformance and design deficiencies identified during warranty-period commissioning.

F. Mechanical and Electrical Designers/Engineers

1. Construction and Acceptance Phase

- a. Perform normal submittal review, construction observation, as-built drawing preparation, etc., as contracted with Owner. Conduct one site observation just prior to system start-up.
- b. Provide design narrative and sequence of operation documentation requested by the CxP. The designers shall assist (along with the contractors) in clarifying the operation and control of commissioned equipment in areas where the Specifications, control drawings or equipment documentation is not sufficient for writing detailed testing procedures.
- c. Attend commissioning kickoff and scoping meetings and other selected commissioning team meetings as contracted with the Owner.
- d. Participate in the resolution of system deficiencies identified during commissioning, according to the contract documents.
- e. Coordinate resolution of issues identified during the (3) three Design Reviews (DD, SD and CD phases of the drawings and specifications) in according with the contract documents.
- f. Prepare and submit record drawings and documentation for inclusion in the O&M manuals. Review and accept the O&M manuals.
- g. Provide a presentation in accordance with Section 017900 at the final training session for the Owner's personnel. The final training will discuss the overall/general functions of mechanical and electrical systems. The session will also be structured to address specific topics that trainees need to discuss and to answer questions concerning operation of system.
- h. Review the Const-CK (equipment or system specific checklist's prepared by CxP) for major pieces of equipment for sufficiency prior to their use.
- i. Review the test procedure forms for major pieces of equipment for sufficiency prior to their use.
- j. Final single line drawings for the water and air side of the entire HYAC system. Drawings should contain location of all dampers, coils, fans, sensors, etc. Drawings should be provided to CxP for review at same time as O&M Manuals (thirty (30) days prior to initial training).

2. Warranty Phase

- a. Participate in the resolution of non-compliance, non-conformance and design deficiencies identified during construction on warranty-period through the commissioning process.

- G. Commissioning Provider (CxP): The CxP is not responsible for design concept, design criteria, compliance with codes, design or general construction scheduling, cost estimating, or construction management. The CxP may assist with problem-solving, non-conformance or deficiencies, but ultimately that responsibility resides with the GC and the A/E. The primary role of the CxP is to develop and coordinate the execution of a commissioning testing plan, observe and document performance that systems are functioning in accordance with the documented Owner's Project Requirements and Performance Criteria and in accordance with the Contract Documents. The contractors will provide all tools or the use of tools to start, access equipment, check-out and performance test equipment and systems, except for specified testing with portable data-loggers, which shall be supplied and installed by the CxP.
1. Design Phase
 - a. Follow the commission in scope defined in the OPR and CFR.
 2. Construction and Acceptance Phase
 - a. Coordinates and directs the commissioning activities in a logical, sequential and efficient manner using consistent protocols and forms, centralized documentation, clear and regular communications and consultations with the necessary parties, frequently updated timelines and schedules and technical expertise.
 - b. Coordinate the commissioning work and, with the GC and Owner and/or O-REP, ensure that commissioning activities are being scheduled into the master schedule.
 - c. Revise, as necessary, Commissioning Plan - Construction Phase.
 - d. Plan and conduct a Commissioning Kickoff and Scoping meetings.
 - e. Request and review additional information required to perform commissioning tasks, including O&M materials, contractor start-up and checkout procedures. Before start-up review current control sequences and interlocks and work with contractors and design engineers until sufficient clarity has been obtained, in writing, to be able to write detailed testing procedures.
 - f. Develop the format for, and coordinate the completion of the emergency power and fire alarm response matrix as defined in this section.
 - g. Review normal contractor submittals applicable to equipment, systems and assemblies being commissioned concurrent with the A/E reviews for compliance with commissioning, O & M needs, and coordination issues.
 - h. Write and distribute construction checklists (Const-CK) for commissioned equipment and components of the building enclosure.
 - i. Reviews the enhanced start-up and initial systems checkout plan developed for selected equipment by the contractors.
 - j. Perform site visits, as necessary, to observe equipment, component and systems and assembly installations. Attend selected planning and job-site meetings to obtain information on construction progress. Review construction meeting minutes for revisions/substitutions relating to the commissioning process. Assist in resolving discrepancies.

- k. Document construction checklist completion by reviewing completed construction checklists and by selected site observation.
- l. Witness the HVAC piping test and flushing procedure, sufficient to be confident that proper procedures were followed. Document this testing and include the documentation in O&M manuals. Notify Owner and/or the O-REP of any deficiencies in results or procedures.
- m. Witness ductwork testing and cleaning procedures, sufficient to be confident that proper procedures were followed. Document this testing and include the documentation in O&M manuals. Notify Owner and/or the O-REP of any deficiencies in results or procedures.
- n. Document systems start-up by reviewing start-up reports and by selected site observation.
- o. Write commissioning test procedures for equipment and systems. This will include manual testing, energy management control system trending and may include stand- alone data-logger monitoring. The CxP will write detailed test procedures for commissioned equipment, systems and assemblies, and submit to O-REP, contractors' and A/E for review and approval unless noted otherwise in the specifications.
- p. Review TAB execution plan.
- q. Witness sufficient commissioning testing of the control system to verify it may be used for TAB, before TAB is executed.
- r. Verify air and water systems balancing by spot testing, by reviewing completed reports and by selected site observation.
- s. Analyze performance trend logs and monitoring data to verify performance.
- t. Coordinate through GC and Owner and/or the O-REP, witness and verify manual PTs performed by installing Contractors. Coordinate re-testing as necessary until satisfactory performances achieved.
- u. Maintain a master deficiency and resolution log (Issues Log) and a separate testing record. Provide the O-REP and A/E with written progress reports and test results with recommended actions.
- v. Review equipment warranties to ensure that the Owner's responsibilities are clearly defined.
- w. Oversee and verify the training of the Owner's operating personnel.
- x. Compile and maintain a Commissioning Record and Building Systems book(s).
- y. Review and verify the preparation of the O&M manuals.
- z. Provide a Final Commissioning Report.

3. Warranty Phase
 - a. Coordinate and supervise required seasonal or deferred testing and deficiency corrections.
 - b. Return to the site at 10 months into the 12-month warranty period and review with facility staff the current building operation and the condition of outstanding issues related to the original and seasonal commissioning. Also interview facility staff and identify problems or concerns they have operating the building as originally intended. Make suggestions for improvements and for recording these changes in the O&M manuals. Identify areas that may come under warranty or under the original construction contract. Assist facility staff in developing reports, documents and requests for services to remedy outstanding problems.
- H. Owner and/or the O-REP
 1. Design Phase
 - a. In predesign, develop the Owner's Project Requirements (OPR) or Current Facility Requirements documenting:
 1. High level project goals and objectives and the benchmarks that will be used to evaluate achievement of stated goals and objectives.
 2. Commissioning provider scope appropriate for the project.
 3. Design team participation in the commissioning process including OPR/CFR workshop, responses to design review comments and meeting to resolve design issues, incorporation of commissioning specifications into project manual, development and delivery of basis of design documentation, training of O&M staff, etc.
 - b. Intervals within the design schedule design documents will be submitted for review.
 2. Construction and Acceptance Phase
 - a. Facilitate the coordination of the commissioning work by the CxP, and with the GC and CxP, ensure that commissioning activities are being scheduled into the master schedule.
 - b. Review and Accept and/or Reject the final Commissioning Plan - Construction Phase.
 - c. Attend a Commissioning Kickoff and Scoping meetings and other commissioning team meetings.
 - d. Perform the normal review of contractor submittals.
 - e. Authorize the GC to furnish a copy of all construction documents, addenda, change orders, approved submittals, shop drawings, etc. related to the project to the CxP.
 - f. Review and accept and/or reject the test procedures submitted by the CxP, prior to commissioning testing.
 - g. When necessary, observe and witness Const-CK, start-up and Commissioning Testing of selected equipment.
 - h. Review commissioning progress and deficiency reports.

- i. Coordinate the resolution of non-compliance and design deficiencies identified in all phases of commissioning.
- j. Sign-off (final approval) on individual commissioning tests as completed and passing.
- k. Assist the GC in coordinating the training of Owner personnel.
- l. Manage the contract of the A/E and of the GC.

3. Warranty Phase

- a. Assist the CxP as necessary in the seasonal or deferred testing and deficiency corrections required by the Specifications.

I. Contractor - General

1. Construction and Acceptance Phase

- a. Facilitate the coordination of the commissioning work by the CxP with the Subs to ensure that commissioning activities are scheduled per project scheduling requirements and updated in the project specifications.
- b. Include the cost of commissioning incurred by the Contractor in the contract price.
- c. Forward completed Const-CKs to CxP weekly or monthly as specified.
- d. In each purchase order or subcontract written, include requirements for submittal data, O&M data, commissioning tasks and training.
- e. Ensure that Subcontractors and equipment or material suppliers execute their commissioning responsibilities according to the bidding documents and schedule.
- f. Schedule and attend a Commissioning Kickoff and Scoping meeting and other necessary meetings requested by the CxP to facilitate the commissioning process.
- g. Address current punch list items before scheduling commissioning testing.
- h. Verify completion of Const-CK and Coordinate test schedule with CxP and required contractors.
- i. Provide skilled technicians to execute starting of equipment and execution of commissioning tests. Ensure that required personnel are available and present, during the agreed-upon schedule, and to complete test procedure adjustments and problem solving unidentified issues. Correct deficiencies (differences between specified and observed performance) as interpreted by the CxP, Designer and Engineer and retest the equipment as necessary.
- j. Prepare red-line as-built drawings that properly identify field conditions from contractor-generated coordination drawings.
- k. Provide and coordinate training of the Owner's operating personnel as specified and as outlined in the Commissioning Plan.
- l. Provide a complete summary of manufacturers to determine requirements to maintain the validity of the materials, equipment, system and warranty.

- m. Prepare O&M manuals, according to the bidding documents, including clarifying and updating the original sequences of operation to as-built conditions and sent to CxP for review thirty (30) days prior to initial training.
 - n. Provide additional requested documentation, prior to normal O&M manual submittals, as outlined in Para. 1.07 of this section.
2. Warranty Phase
- a. Ensure seasonal, post occupancy and deferred testing (if required) is executed and witnessed by the CxP, according to the Project Manual.
 - b. Ensure that deficiencies are corrected and necessary adjustments made to O&M manuals and as-built drawings for applicable issues identified in any seasonal or deferred testing.
- J. Contractor - Mechanical, Controls, and HVAC Test & Balance
1. Construction and Acceptance Phase
- a. Contractor shall assist (along with the Designer) in clarifying the operation and control of commissioned equipment in areas where the Specifications, control drawings or equipment documentation is not sufficient for writing detailed testing procedures.
 - b. Provide limited assistance to the CxP in preparing the Test Procedures. Contractor shall review test procedures to ensure feasibility, safety and equipment protection and provide necessary written alarm limits to be used during the tests.
 - c. Develop a full start-up and initial checkout plan using manufacturer's start-up procedures and the Const-CK from the CxP for commissioned equipment. Submit to CxP for review and approval prior to start-up. Refer to Section 3.02 for further details on start-up plan preparation.
 - d. Perform and clearly document the start-up and system operational checkout procedures, providing a completed copy to the CxP.
 - e. Air and water TAB shall be completed with discrepancies and problems remedied before commissioning testing of the respective air- or water-related systems.
- K. Contractor- Mechanical: The responsibilities of the Contractor, during construction and acceptance phases in addition to those listed in J. above are:
1. Assist and cooperate with Testing and Balancing and CxP by:
- a. Putting all HVAC equipment and systems into operation and continuing the operation during each working day of TAB and commissioning, as required.
 - b. Including cost of sheaves and belts changes that may be required by TAB.
 - c. Providing test holes in ducts and plenums where directed by TAB to allow air measurements and air balancing. Provide an approved plug.
 - d. Providing temperature and pressure taps according to the Construction Documents for TAB and commissioning testing.

2. Install a Pressure/Temperature (P/T) plug within 4" of water sensors that are input points to the control system.
 3. List and clearly identify on the as-built drawings and system manual drawings the locations of air-flow stations.
 4. Prepare a preliminary schedule for Divisions 22 and 23 pipe and duct system testing, flushing and cleaning, equipment start-up for use by the CxP. Update the schedule as appropriate.
 5. Notify the CxP when pipe and duct system testing, flushing, cleaning, start-up of each piece of equipment. Notify the CxP, ahead of time, when commissioning activities not yet performed or not yet scheduled will delay construction. Be proactive in seeing that commissioning processes are executed and that the CxP has the scheduling information needed to efficiently execute the commissioning process.
- L. Contractor - Controls and Instrumentation: The commissioning responsibilities of the Contractor, during construction and acceptance phases in addition to those listed in J above are:
1. Sequences of Operation Submittals: The Contractor's submittals of control drawings shall include complete detailed sequences of operation for each piece of equipment, regardless of the completeness and clarity of the sequences in the Specifications. They shall include:
 - a. An overview narrative of the system (1 or 2 paragraphs) generally describing its purpose, components and function.
 - b. Interactions and interlocks with other systems.
 - c. Written sequences of control for packaged controlled equipment. (Equipment manufacturers' stock sequences may be included, but will generally require additional narrative).
 - d. Start-up sequences.
 - e. Warm-up mode sequences.
 - f. Normal operating mode sequences.
 - g. Unoccupied mode sequences.
 - h. Shutdown sequences.
 - i. Capacity control sequences and equipment staging.
 - j. Temperature and pressure control: setbacks, setups, resets, etc.
 - k. Detailed sequences for all control strategies, e.g., economizer control, optimum start/stop, staging, optimization, demand limiting, etc.
 - l. Effects of power or equipment failure with standby component functions.
 - m. Schedules of alarms and trigger setpoints.
 - n. Emergency shutdown procedures.
 - o. Schedule of original setpoints, parameters, and other control settings or fixed values, delays, etc. that will be useful during testing of equipment.
 - p. Seasonal operational differences and recommendations.

- q. Schedule of final setpoints and parameters that are typically set or adjusted by operating staff; and any other control settings or fixed values, delays, etc. that will be useful during operation of the equipment.
 - r. To facilitate referencing in testing procedures, sequences shall be written in small statements, each with a number for reference. For a given system, numbers will not repeat for different sequence sections, unless the sections are numbered or provide ladder logic diagrams illustrating the control programming.
2. Control Drawings Submittal
- a. The control drawings shall have a key to all abbreviations.
 - b. The control drawings shall contain graphic schematic depictions of the systems and each component.
 - c. The schematics will include the system and component layout of any equipment that the control system monitors, enables or controls, even if the equipment is primarily controlled by packaged or integral controls.
 - d. Provide a full points list with at least the following included for each point:
 - 1. Controlled system
 - 2. Point abbreviation/label
 - 3. Point description - DB temp, airflow, etc.
 - 4. Display unit
 - 5. Control or set point - point that controls equipment and can have its set point changed (OSA, SAT, etc.)
 - 6. Monitoring point - Point that does not control or contribute to the control of equipment, but is used for operation, maintenance, or performance verification.
 - 7. Intermediate point - point whose value is used to make a calculation which then controls equipment (space temperatures that are averaged to a virtual point to control reset).
 - 8. Calculated point - virtual point generated from calculations of other point values. The Contractor shall keep the CxP informed of all changes to this list during programming and setup.
3. An updated as-built version of the control drawings and sequences of operation shall be included in the final controls O&M manual submittal and a copy furnished to the CxP.
4. Assist and cooperate with the CxP in the following manner:
- a. Using a skilled technician who is familiar with this building, execute the testing of the controls system as specified for Contractor project Contract Documents. Assist in the testing of equipment specified in project Contract Documents.
 - b. Execute control system trend logs specified in project Contract Documents.

5. The Contractor shall prepare a written plan, indicating in a step-by-step manner, the procedures that will be followed to verify the control system. At minimum, the plan shall include for each type of equipment controlled by the automatic controls:
 - a. Test System name
 - b. List of devices
 - c. Step-by-step procedures for testing each controller after installation, including:
 1. Process of checking proper hardware and wiring installation.
 2. Process of downloading programs to local controllers and checking that they are addressed correctly.
 3. Process of performing operational checks of each controlled component.
 4. Plan and process for calibrating valve and damper actuators and all sensors.
 5. A description of the expected field adjustments for transmitters, controllers and control actuators which can be used in the event that control responses fall outside of expected values.
 6. Provide a signed and dated certification to the CxP upon completion of the checkout of each controlled device, equipment and system prior to testing for each piece of equipment or system, that system programming is complete as to respects of the Bidding Documents, except testing requirements.
 7. Beyond the control points necessary to execute documented control sequences, provide monitoring, control and virtual points as specified.
 8. List and clearly identify on the as-built duct and piping drawings the locations of static and differential pressure sensors (air, water and building pressure).
 9. Provide fittings, operations, and connections necessary for testing CO₂, CO, VOC, particulate, etc. sensors installed as part of the building automation system. CxP will provide test gas as appropriate for each sensor.
- M. Contractor - Testing, Adjusting & Balancing (TAB): The duties of the Contractor, in addition to those listed in K & L above are:
1. Submit the outline of the TAB plan and approach for each system and component to the CxP six (6) weeks prior to starting the TAB. This plan will be developed after the Contractor has some familiarity with the control system and general construction schedule.
 2. The submitted plan will include:
 - a. Certification that the Contractor has reviewed the construction documents and the systems with the design engineers and contractors to sufficiently understand the design intent for each system.

- b. An explanation of the intended use of the building control system. The Contractor will comment on feasibility of the plan.
- c. Field checkout sheets and logs to be used that list each piece of equipment to be tested, adjusted and balanced with the data cells to be gathered for each.
- d. Discussion of what notations and markings will be made on the installed duct and piping and their associated drawings during the process.
- e. Final test report forms to be used.
- f. Detailed step-by-step procedures for TAB work for each system and issue: terminal flow calibration (for each terminal type), diffuser proportioning, branch/ sub-main proportioning, total flow calculations, rechecking, diversity issues, expected problems and solutions, etc. Criteria for using air flow straighteners or relocating flow stations and sensors will be discussed. Provide the analogous explanations for the water side.
- g. List of all air flow, water flow, sound level, electrical data, system capacity and efficiency measurements to be performed and a description of specific test procedures, parameters, formulas to be used.
- h. Details of how total flow will be determined (Air: sum of terminal flows via BAS calibrated readings or via hood readings of terminals, supply (SA) and return air (RA) pitot traverse, SA or RA flow stations. Water: pump curves, circuit setter, flow station, ultrasonic, etc.).
- i. The identification and types of measurement instruments to be used, their serial numbers and most recent calibration date.
- j. Specific procedures that will ensure that both air and water side are operating at the lowest possible pressures and methods that will be used to check this.
- k. Confirmation that TAB understands the outside air ventilation criteria under all conditions.
- l. Details of how minimum outside air cfm will be verified and set and minimum/maximum setpoints with summation of the difference between exhaust and make-up air at minimum OSA setpoints (total building, zone, etc.).
- m. Details of how building static and exhaust fan/ relief damper capacity will be checked.
- n. Proposed selection points for sound measurements and sound measurement methods.
- o. Details of methods for making any specified coil or other system plant capacity measurements.
- p. Details of any TAB work to be done in phases (by floor, etc.) or of areas to be built out later.
- q. Details regarding specified deferred or seasonal TAB work.
- r. Details of all exhaust fan balancing and capacity verifications, including any required room pressure differentials.

3. A running log of events and issues shall be kept by the Contractor. Submit hand-written reports of discrepancies, deficient or uncompleted work by others at completion of each site visit, contract interpretation requests and lists of completed tests to the CxP.
 4. Communicate in writing to the Contractor and CxP all set point and parameter changes made or problems and discrepancies identified during TAB which affect the control system setup and operation.
 5. Provide a draft TAB report within two weeks of completion to CxP with a copy to the Engineer. The report will contain a full explanation of the methodology, assumptions and the results in a clear format with designations of uncommon abbreviations and column headings. The report should follow the latest and most rigorous reporting recommendations by AABC, NEBB or ASHRAE Standard 111.
 6. Provide the CxP and Engineer with any requested data gathered, but not shown on the draft reports.
 7. Provide a final TAB report to the CxP and the Engineer with details, as in the draft.
 8. Conduct Tests and checks as necessary to demonstrate the accuracy of the report to the CxP as specified for TAB in project Contract Documents.
- N. Contractor - Electrical: The commissioning responsibilities applicable to the Contractor for electrical systems are as follows (all references apply to commissioned equipment only):
1. Construction and Acceptance Phase
 - a. Contractor shall assist (along with the design engineers) in clarifying the operation and control of commissioned equipment in areas where the Specifications, control drawings or equipment documentation are not sufficient for writing detailed testing procedures.
 - b. The contractor shall review test procedures to ensure feasibility, safety and equipment protection and provide necessary written alarm limits to be used during the tests.
 - c. Perform and clearly document completed pre-energizing construction checklists (Const-CK) and system operational checkout procedures, providing a copy to the CxP for review.
 2. Warranty Phase
 - a. Remove electrical distribution covers for CxP to conduct thermographic imaging scans when electrical system is electrically loaded and reinstall covers at completion of thermography. This test is anticipated to occur within 90 days of building occupancy.

- O. Material Suppliers
 - 1. Provide all requested submittal data, including detailed start-up procedures and specific responsibilities of the Owner to keep warranties in force.
 - 2. Assist in equipment testing per agreements with Subcontractors.
 - 3. Include all special tools and instruments (only available from vendor, specific to a piece of equipment) required for testing equipment according to these bidding documents in the base bid price to the contractor, except for stand-alone data-logging equipment that may be used by the CxP.
 - 4. Provide information requested by CxP regarding equipment sequence of operation and testing procedures.
 - 5. Review test procedures for equipment installed by factory representatives.
 - 6. Provide and assist contractors in training of owner's operating personnel in accordance with Section 01 79 00.

- P. Contractors - Building Enclosure: The commissioning responsibilities applicable to the Contractor for building enclosure systems are as follows:
 - 1. Construction and Acceptance Phases
 - a. Attend a Commissioning Kickoff and Scoping meeting and other meetings necessary to facilitate the commissioning process.
 - b. Contractors shall provide the CxP with normal cut sheets and shop drawing submittals of commissioned components and composite assemblies.
 - c. Provide additional requested documentation, prior to completion of mock-up assemblies, to the CxP for finalizing commissioning testing procedures.
 - 1. Typically, this will include detailed manufacturer installation instructions, testing laboratory certifications/reports, and maintenance procedures, full details of any Owner-contracted tests, full factory testing reports, and full warranty information, including responsibilities of the Owner to keep the warranty in force clearly identified. In addition, the installation materials that are actually shipped with the building enclosure exterior wall components and the actual field checkout sheet forms to be used by the factory or field technicians shall be submitted to the CxP.
 - 2. The CxP may request further documentation necessary for the commissioning process.
 - 3. This data request may be made prior to normal submittals.
 - d. Provide a copy of the submittals of commissioned building enclosure components, through normal channels, to the CxP for review and comment. Provide sufficient O&M data necessary to understand, operate, and maintain the system and/or assemblies and to inform those not involved in the design and construction process about the systems and assemblies. O&M data shall be provided in accordance with Section 01 78 01.

- e. Contractors shall assist (along with the design professionals) in clarifying the installation and operation of commissioned assemblies in areas where the Specifications or component/assembly documentation is not sufficient for writing detailed commissioning testing procedures.
- f. Provide limited assistance to the CxP in preparing the specific performance test procedures required. Subs shall review test procedures to ensure feasibility, safety and material protection during tests.
- g. Develop initial and full checkout plan using manufacturer's procedures and the Const-CK for commissioned assemblies. Submit to CxP for review and approval prior to proceeding with installation of building enclosure.
- h. During the initial checkout process, execute the Const-CKs as provided via the GC by the CxP for components of the exterior wall and roof assembly to be commissioned.
- i. Perform and clearly document completed checkout procedures as required and/or listed on the Const-CK providing a signed and dated certification copy to the CxP.
- j. At applicable wall locations, conduct performance testing before installation of insulation and interior closure of the wall. Address current A/E punch list items before performance testing. Exterior Wall Contractors will provide installation foreman to assist with execution of the TPs conducted on the mock-up assemblies to resolve installation issues and establish future installation practices necessary to correct deficiencies observed prior to commencing with installation of the exterior wall systems.
- k. Exterior Wall Contractors will ensure that the installation foreman and sufficient labor assistance are available and present during the scheduled tests, adjustments and problem solving events.
- l. At exterior wall, window, curtain wall, roof, roof drains, back-up drains, scuppers, skylights, etc., provide access to the test area for both the CxP representative and the contractor's work force, via ladders, scaffolding, man-lifts, etc. If the subcontractor does not have access equipment, the GC is to provide the necessary equipment for access required for commissioning.
- m. Provide labor necessary to execute test procedure under direction of the CxP.
- n. Correct deficiencies as interpreted by the CxP, GC, Owner and/or O-REP and A/E and retest as required.
- o. Prepare redline as-built mark-ups for all applicable drawing sheets.
- p. Provide training of the Owner's operating personnel in accordance to Yellow Book criteria and project contract documents.

6.01 Systems to be Commissioned

- A. The following systems shall be commissioned in this project.
1. Building Enclosure:
 - a. Roofing system - water-proofing, insulation, roof membrane, rain and ice shield, pitch, coping, flashing, curbs for mechanical equipment, downspouts, drains, scuppers
 - b. Exterior skin - curtain wall, storefront, masonry, brick/ stone veneers, precast panels, metal panels, stucco, siding, sun shades, expansion joint cover assemblies.
 - c. Walls - vapor barriers, insulation, mortar nets, weeps, joints, sealants, masonry ties, damp proofing, composite sheet waterproofing, flashing
 - d. Slab on grade - vapor barriers, waterproofing, drainage, foundation drains, crystalline waterproofing
 - e. Doors and windows - sealants, mechanical operation, sills, flashing, end dams, hardware
 - f. Water tests, mockups, wind loads, thermal infiltration
 - g. Special design features --cornice, canopy, skylights, etc.
 - h. Potential special roof conditions - green roof; roof terrace/roof garden
 2. Mechanical Systems:
 - a. Thermometers & gauges
 - b. Vibration isolation
 - c. Steam and condensate system
 - d. Hot water heating systems
 - e. Dedicated split system air conditioners and heat pumps
 - f. Chemical water treatment systems
 - g. Air terminal unit systems, VAV, AHU, chilled beams, etc.
 - h. Humidifiers and controls
 - i. Duct silencers
 - j. Dampers
 - k. Variable frequency drives & motors
 - l. Air distribution systems
 - m. Exhaust air systems and building pressurization controls
 - n. Test and balance verification
 - o. Refrigeration equipment and controls
 - p. Chilled water system
 - q. Boilers

3. HVAC Control Systems
 - a. Component FPT and calibration
 - b. Control air supply
 - c. Air terminal units (non-lab)
 - d. Sequence controls to include:
 - e. AHU, 100% OSA
 - f. EAHU, HVAC equipment
 - g. AHU,H&V
 - h. Exhaust air fans
 - i. Differential bypass valve
 - j. Air terminal units, CV
 - k. Air terminal units, VAV / CV
 - l. Air terminal units, VAV
 - m. Heat exchanger
 - n. Variable speed pumps
 - o. Cabinet unit heaters
 - p. Humidifiers
 - q. Water heaters
 - r. Heating coils / radiant panels
 - s. Operation of equipment during switchover from normal to emergency power and vice versa.
 - t. Equipment failure modes and recovery
 - u. Graphic display
 - v. Trend logs (CxP to define and review required trend logs over extended period)
 - w. Status review screens, checks and alarming
 - x. Network communication
 - y. Dashboard
 - z. Metering (to include verification of communication to Ion database)
4. Plumbing
 - a. Cleaning / flushing water systems
 - b. Water filtration (general use)
 - c. Domestic hot water systems
 - d. Tempered water systems

5. Electrical Systems:
 - a. Service switchgear
 - b. Emergency power system
 - c. Generators
 - d. Lighting controls (scheduled activators and occupancy sensors)
 - e. Daylight dimming controls
 - f. Switchboards
 - g. Distribution panel boards
 - h. Motor control centers
 - i. Power monitoring and metering
 - j. Transient voltage surge suppressors
 - k. Variable frequency and speed drives
 - l. Grounding and ground fault systems
 - m. Over-current protective devices
 - n. ATS auto transfer switches
 - o. Buss duct and tap devices
 - p. Fire alarm and smoke detectors
 - q. Standby and emergency power systems
 - r. Emergency lighting
 - s. Electrical primary voltage system
 - t. Security systems
6. Renewable Energy Systems:
 - a. Heat recovery systems
 - b. Controls and thermostats
 - c. Photovoltaic cell panels (solar power systems)
 - d. Solar hot water systems
 - e. Geothermal systems
 - f. Cistern pumps & filtration

7.01 Meetings

- A. Scoping Meeting. Within 60 to 90 days of commencement of construction, the CA will schedule, plan and conduct a commissioning scoping meeting with the entire commissioning team in attendance. Meeting minutes will be distributed to all parties by the CA. Information gathered from this meeting will allow the CA to revise the Draft 2 *Commissioning Plan* to its final version, which will also be distributed to all parties.
- B. Miscellaneous Meetings Other meetings will be planned and conducted by the CA as construction progresses. These meetings will cover coordination, deficiency resolution and planning issues with particular Subs. The CA will plan these meetings and will minimize unnecessary time being spent by Subs. For large projects, these meetings may be held monthly, until the final 3 months of construction when they may be held as frequently as one per week.

8.01 Reporting

- A. The CxP will provide regular reports to the CM or PM, depending on the management structure with increasing frequency as construction and commissioning Standard forms are provided and referenced in the Commissioning Plan.

END OF SECTION

022100 – SURVEYS

1.01 General

- A. The following specifications and standards are to be followed in the performance of topographic, utility and boundary surveying on the Georgia Tech campus.
1. A complete survey is to be performed for each building/project site by a registered land surveyor who is duly licensed in the State of Georgia. Survey shall include property boundaries, topography, plan metrics and underground utilities.
 2. Surveyor must have Errors and Omission Insurance of not less than \$1,000,000.
 3. Survey is to include information for, but not necessary limited to, topography, buildings, roads, sidewalks, etc., subsurface and above and below ground utilities, including closest point of utility system tie-in if not on site, easements, significant vegetation, and any zoning or covenant requirements, such as setbacks, etc. Surveyor is to allow Georgia Tech Office of Facilities to review and comment on survey before submission of final hard copy and electronic deliverables.
 4. All work is to be performed in accordance with the Minimum Technical Standards for land surveying in the State of Georgia, the requirements of this document, and with the current requirements of the Board of Regents of the University System of Georgia, the Georgia State Financing and Investment Commission, and the Georgia Institute of Technology, as identified in the following manuals:
 - a. Building Project Procedure 2000
 - b. Board of Regents of the University System of Georgia
 - c. Georgia State Financing and Investment Commission
 - d. Form No. G.A.-5, Memorandum of Policy
 5. Surveyor is responsible to obtain full copies of the current project requirements.
 6. Vertical datum shall be NAVD (North American Vertical Datum) of 1988. The use of assumed elevations for benchmarks is not acceptable.
 7. Horizontal datum shall be NAD 83/ (HARN96), Georgia West Zone. The use of local or assumed coordinate systems is not acceptable.
 8. Survey shall state whether the property or topographic area being surveyed does or does not lie within a flood zone, and shall identify the map number for the FEMA F.I.R.M. referenced. Survey shall show the limits of each flood zone as it affects the property or topographic area being surveyed. If the flood zone is studied and has BFE survey shall show the correct location of the flood limits. If the flood zone is unstudied and the location shown on the survey is scaled, survey shall show the line as approximate location scaled from the flood map. Label on the survey the correct flood zone designations with the respective information on the correct side of the line.
 9. The following functional requirements of a survey for Georgia Institute of Technology:

- a. To provide an accurate representation of all surface and subsurface objects and features in the project boundary.
- b. To provide an electronic document to the designers of the project which represents the existing conditions on the surface and subsurface. Because all of the design efforts for Georgia Institute of Technology will be in BIM design systems it is a fundamental requirement that all supporting design work be in 3D modeling. Thus the beginning of a project is the survey. Therefore all surface features/objects shall be 3D AutoCAD Civil 2010 or later, all subsurface pressurized systems shall be in AutoCad MEP 2010 or later. All underground utilities and structures shall be 3D objects in a separate file that is XREF.

2.01 Drawing Guidelines

- A. All survey plat and drawings shall show the following:
 - B. North arrow - North shall be oriented toward the top of the sheet.
 - C. Scale - numeric and graphic.
 - D. Title block
 - E. The name of the project.
 - F. The name and address of the surveyor.
 - G. The date.
 - H. The address of the property.
 - I. Not less than three permanent monuments shall be established for sites of 3 acres and larger. Monuments to be 3" brass disk set with concrete cylinder, 18" deep with 12" iron spike in bottom. Monuments shall be established outside of the area that will be disturbed by construction of the project. Survey drawings and plats shall indicate horizontal and vertical datum for survey monuments and control points.
 - J. One property corner on each site shall be referenced by survey to the horizontal and vertical control.
 - K. A complete legend is to be shown, including all abbreviations, symbols and line types.
 - L. Georgia Tech has existing control points at various locations across the campus. Any of these points that fall within the area of the survey are to be shown on the survey drawing.
 - M. Create survey a drawing file with all surface features/objects shall be in 3D AutoCAD Civil 2010 or later, all subsurface pressurized systems shall be in AutoCad MEP 2010 or later. All underground utilities and structures shall be 3D objects and supply on CD-ROM. Survey information will be separated with the layer system established by the AIA CAD Layer Guidelines as published in the United States National Cad Standards Manual. CAD data shall be in engineering units (decimal feet) and CAD files shall include all external reference files. AutoCad drawing files shall be produced at a scale of 1 to 1 in model space i.e. drawing measurements between two objects to be equal to the actual physical distance measured in the field in decimal feet. All symbols, lettering, fonts, shapes, and blocks shall be saved with each drawing.

- N. Existing records and survey will be provided, if available, by the Georgia Tech Office of Facilities, 955 Fowler St., NW, Atlanta, GA. Georgia Tech is not responsible for errors or omissions in these records.

3.01 Boundary Survey

- A. Boundary surveys shall meet the minimum technical standards for the State of Georgia, along with ALTA/ACSM Land Title Survey requirements, if an ALTA survey is requested by Georgia Tech.
- B. At minimum, surveyor shall:
 - 1. Locate all property corners and set permanent markers for any missing corners.
 - 2. Provide a survey plat drawn to a scale of 1-inch equals 20-feet or as otherwise requested by Georgia Tech Office of Facilities which illustrates:
 - a. Bearing, distance, and appropriate curve data for all property lines.
 - b. Type and size of all survey markers set.
 - c. Improvements within 25 feet outside of property lines, if surveyor can obtain permission from the adjoining land owner or tenant.
 - d. All possible encroachments, overlaps or gaps between adjoining properties.
 - 3. Provide a legal description for the property surveyed.
 - 4. Locate alleys, right of ways, streets, easements, and other items of similar nature on or adjoining the property with property identification of each. In the case of an easement, indicate underground, surface, or overhead improvements for which the easement was established. Surveyor shall not be required to run title searches.

4.01 Topographic and Utilities Surveys:

- A. Survey shall meet the following minimum requirements: Contours:
 - 1. Establish permanent base reference elevation point from which contours are established and elevation of building floors can be determined.
 - 2. Include entire site, extending contours to the survey limits, to 25 feet beyond property lines and to the far side of adjacent streets.
 - 3. Standard contour interval shall be 1-foot for sites with majority of slopes under 10% (atypical site).
 - 4. Contour interval of 2-feet may be acceptable for sites with majority of slopes over 10% if approved in advance by Georgia Tech's designated project manager. Otherwise contour interval of 1-foot shall be used for area where slopes are less than 10%.
 - 5. Provide spot elevations of existing structures, curbs, crown of roads, drainage rims/covers, top and bottom of retaining walls, etc. Provide spot elevations as necessary to adequately define tops and bottoms of slopes, drainage swales, and drainage patterns.
 - 6. Show any rapid changes in grade on adjacent property.

7. At minimum, provide spot elevations across site at approximately 50 foot grid intervals.
 8. Contours and street and/or landscape shall be provided in an AutoCad drawing file and shall be continuous elevated polylines and shall be in 3D with each elevation line located in the Z axis at the noted elevation.
 9. Survey work shall include removal of silt and debris materials to establish true depths, invert elevations, sections and elevations for roadway pavements, curb and Gutter, culverts, storm drainage structures and pipes, sanitary sewer manholes and pipes, etc.
 10. Surveyor to coordinate with Georgia Tech Plant Operations personnel in the event that utility structures or pipes are obstructed with more than a minimal amount of debris.
 11. Footprints and finished floor elevations for all building structures.
 12. Finished floor elevations shall be provided at all building entrances.
 13. All deciduous and coniferous trees 6-inches in caliper and larger.
 14. Show botanical name, common name and caliper measured at approximately 48-inches above ground surface.
 15. Show road and street markings including: stop bars, cross walks, white stripes, yellow stripes, dashed lines, directional arrows, and painted islands. Show all parking lot markings including, cross walks, parking strips, handicap markings and signs, and painted islands/gores.
- B. Surveyor shall engage a private utility locator to mark underground utilities in accordance with CI/ASCE 38-02 Standard of Quality Level C using GPR (ground penetrating radar) and/or other similar utility locating devices. Utility locator must have a minimum of 5 years' experience in marking underground utilities, and must have Errors and Omission Insurance of not less than \$1,000,000.
- C. Utility locator shall locate and mark all traceable underground utilities within the survey area as follows:
1. Research public utility records, private utility company records, and facility utility records to determine the existence of all underground utilities within the survey area.
 2. Mark all underground utilities within the survey area. Determine and record depths to within plus or minus 1-foot in accuracy.
 3. Provide all utilities found consisting of size, type, material, in 3D see "DRAWING GUIDELINES" and identify controlling entity in the LEDGND.
 4. Provide horizontal and vertical location of the all the underground utilities marked within the survey area.
 5. Utility locator is to review the final survey and certify that utilities shown are correct.
 6. Utilities locating service is not intended to include tracing of sanitary sewer service lines, roof drain leaders and other non-traceable sanitary sewer and storm drain connections that are not evidenced by above ground features or shown on available utility maps.

7. Utilities on the Georgia Tech campus typically include the following. Water mains, services and appurtenances including fire hydrants, valves, PIV's, FDC's, meters and BFP vaults; survey to indicate sizes and materials.
8. Gas mains, services CAD in 3D pipe sizes, and meters; survey to indicate sizes and materials.
9. Sanitary sewer manholes, mains and services CAD in 3D pipe sizes; survey to indicate manhole top and invert elevations, pipe sizes and materials.
10. Storm drainage inlets, manholes, pipes, trench drains, and paved ditches; survey to indicate structure top elevations, grate elevations, pipe sizes and materials.
11. Combined sewer manholes, junction boxes, inlets and pipes CAD in 3D pipe sizes.
12. Overhead and underground electric power lines; survey shall indicate actual size of underground electric power manholes, duct bank widths and vaults top, bottom inside spot elevations and outside edges of manhole structures.
13. Overhead and underground duct bank widths telephone and data-com lines.
14. Cable T.V. lines and devices.
15. Steam and condensate return lines, CAD in 3D pipe sizes with insulation, and vaults top, bottom inside spot elevations and outside edges of manhole structures.
16. Chilled water supply and return lines CAD in 3D pipe sizes with insulation and vaults top, bottom inside spot elevations and outside edges of manhole structures.
17. Septic tanks, grease traps, oil grit separators, and fuel tanks.
18. All utilities marked by the utilities locator will be field located and shown on the survey. All other information shown and reported by the utilities locator will be shown on the survey in 3D solid objects. Each utility shall be located on a separate layer. All pressure type utility systems shall be drawn in AutoCAD MEP 2010 or later. In AutoCad MEP for each utility use the appropriate system and layer for the specific utility. The Utility 3D object shall be drawn in the measured/detected elevation in the Z cad plane and the top of pipe/structure shall be noted along the line every 100ft. The specific utility pipe or structure size shall be researched as required above. All pipe and structure labels shall be at Elevation Zero (0). Note: Many subsurface systems are not single pipes, such electrical duct banks, chill water systems and steam distribution systems. The subsurface system usually are 2 ft to 6 ft wide. Note pipes and ductbanks are not laid out in a wave they are in straight lines with designed bends and turns.

19. The surveyor/utility locator shall request public utility location and the surveyor/utility locator shall visit contact/visit each public utility and research their records to obtain public underground utility sizes and shapes. The surveyor/utility locator shall locate and show on the survey in 3D object utilities but not limited to:
 - a. All public utilities and All Georgia Tech owned utilities.
 - b. All structures depth of top and bottom and the outside boundaries of all structures.
 - c. Structures are not limited to but shall include:
 - d. All manholes for electrical, telecommunications, public natural gas, GT-Fiber, GT- Gas (GT owns its own gas distribution system in the northern part of campus), steam and chill water.
 - e. Note steam systems have two lines a steam supply and a condensate return line. Chill water always has a supply and return line. All other information shown and reported by the utilities locator will be shown on the survey as 3D objects.
 - f. This information is to include sizes and types of the underground utilities and information as to why any particular utility whose known presence within the survey area was not marked or not completely marked.
20. In addition, survey shall show any other apparent characteristics that would include but not necessarily be limited to the following:
 - a. Wells
 - b. Ditches, canals, springs, seeps, etc.
 - c. Bodies of water including lakes, ponds, wetlands, floodplains, creeks, and streams. Stream data to include spot elevations adequate to define flow channel and top of bank. Stream buffers.
21. Pothole Services: The surveyor may be asked as an additional task to provide Pothole investigation services and to record these finding on the survey.
 - a. Provide a subcontractor to perform vacuum excavation at designated locations.
 - b. The subcontractor shall have contractor's general liability with limits no less than \$1,000,000 per occurrence. The sub-contractor shall if necessary when working in City of Atlanta streets shall provide all required bonds and insurance to the City of Atlanta to obtain an excavation permit. The excavation contractor shall pay all City of Atlanta fees necessary for the permit.
 - c. The vacuum excavation contractor shall remove hard surface materials in clean cuts using straight lines. The surveyor shall record the elevation of the surface and the elevation of the top of pipe or structure being excavated. The vacuum excavation sub-contractor shall fill the hole with suitable materials and compact to 95% compaction and patch the surface with suitable materials that match the original hard surface materials to provide a non-disturbed appearance.

5.01 Services

- A. New building surveying services shall include quotes to provide the following special plots as additional services:
1. Boundary survey for recording: maximum size 17" x 21" with a legal description of the boundary.
 2. 2D utility plots without topographical and spot elevation.
 3. Signed survey to include all surface features, as described above in "Topographic and Utilities Surveys", without spot elevations of non-structures, underground structures and gravity and pressurized systems.
 4. Provide a CD or Flash Drive with AutoCad files in 3D AutoCAD Civil 2010 or later and all subsurface pressurized systems shall be in AutoCad MEP 2010 or later. All 3D underground utilities and structures shall be 3D objects in a separate file that is XREF into the Topo survey file.

END OF SECTION

030000 CONCRETE

1.01 General:

- A. The Board of Regents Building Project Procedure and their Guidelines require that new construction conform to International Building Code Type IA or IB, NFPA Type 1(443) or 1(332), formerly SBC Type I or II. Modifications to an existing structure should be consistent with the original. Our best experience has been with concrete frame structure including concrete exit stair ways. We strongly favor structural work in reinforced concrete as opposed to steel systems.
- B. Concrete foundation systems are preferred among the alternatives that may be as recommended by the geotechnical engineer. Our best experience with local soil conditions has been with augured cast piling, aka caisson piers, bearing on bed rock. Matt foundations and spread footings are suitable for lower scale structures. Driven steel pilings or geo-pier foundations should not be used.
- C. Exposed poured in place (PIP) concrete should be considered a structural material and finished with a surface coating. Experience with vertical formed surfaces has been unsatisfactory, providing an inferior appearance; and then requiring a coating for restoration of the appearance. Therefore, exterior or interior exposed concrete must be specified to receive a finish material, such as cement stucco or a specification grade concrete coating.
- D. Roof decks of new construction must be designed in concrete unless otherwise submitted and approved by Georgia Tech Design and Construction. Long span steel structure may qualify for a variance. Any request for variance to this requirement should be made to the Campus Architect at the schematic design phase.
- E. Parking garage structures should be concrete. A finish coating is not required on the interior exposed surfaces; however, a white coating in the overhead provides improved lighting reflectance to offset the amount of lighting required. The facade must have an architectural finish material consistent with the character of the campus district, requiring little maintenance over the life of the structure.
- F. Concrete is a structural material. Therefore, either exterior or interior exposed concrete must be coated with a finish material, such as plaster, stucco, e.i.f.s., etc.
- G. Georgia Tech strongly favors the use of light colored concrete (gray or white) because of its high reflectance which assists in reduction of heat island effect.
- H. To the maximum extent feasible and practicable, the construction bid documents are to specify that no less than 90% of materials (in terms of materials and products cost) for concrete construction be harvested, extracted, or manufactured in the State of Georgia. It is Georgia Techs strong preference to begin with the closest local (Atlanta Metropolitan Area) region first, and then move outward within the state, and finally up to the 500 mile region beyond.
- I. Steel rebar shall have a recycled content of at least 80%.

END OF SECTION

040000- MASONRY

1.01 General

- A. Brick masonry to be designed and constructed per the standards set by the Brick Institute of America.
- B. Brick color standard is red range per the palette of the campus. An excellent example of this range can be seen on the Ford Environmental Science and Technology building.
- C. Select mortar tinted in light values of “natural range” colors. Utility grade mortar is not appropriate for architectural brickwork.
- D. Brick selections and mortar colors to be reviewed and approved by Facilities Design and Construction, Campus Architect.
- E. Retaining walls should be constructed of granite with stone caps or structural concrete walls with brick veneer and precast concrete caps. Walls should conform to the Georgia Institute of Technology Campus Landscaping Standards and Master Plan (see Section 01100).
- F. Images of recommended campus rock wall construction are available for reference.
- G. For retaining walls, please refer to Georgia Tech Landscape Standards:
<http://www.facilities.gatech.edu/dc/standards/LANDSCAPE.pdf>

END OF SECTION

050000- METALS

1.01 General

- A. In order to achieve the Fire Rating as required by the Building Code, structural steel and steel decking may be protected with gypsum board sheathing, as well as by sprayed fireproofing systems.
- B. Where gypsum board sheathing protection is not practical, use sprayed fireproofing systems. Where this material is exposed to the interior, a sealer overcoat of acrylic polymer is recommended.
- C. Where conditions require, sprayed thermal insulation can be used in conjunction with sprayed fireproofing. See Division 07.
- D. All structural steel in exterior locations (such as cornices, parapets or canopies) must be steel components that are shop coated and assembled on-site.
- E. Wherever dissimilar metals may come in contact with each other in exterior conditions, they must be separated with an approved layer of bituminous coating. In areas exposed to exterior conditions, galvanized metal or zinc plated fasteners shall not be used to anchor aluminum or copper; use stainless steel, aluminum or copper fasteners.
- F. See also Section 099000 Paints and Coatings.

END OF SECTION

061000- ROUGH CARPENTRY

1.01 General:

- A. Use fire treated 3/4" plywood for backboards in electrical, voice and data rooms.
- B. Use pressure treated wood for blocking where moisture may be encountered, such as below grade locations and roof locations. Recycled composite materials are also acceptable.

END OF SECTION

064000- ARCHITECTURAL WOODWORK

1.01 General:

- A. Comply with Architectural Woodwork Quality Standards, Guide Specifications and Quality Certification Program last adopted Edition.
- B. In food service areas and other areas where wet conditions are present, the preferred material for countertops is solid surfacing material, 2" thick and are expected to have a minimum 10-year lifespan.
- C. Drawer sides and backs to be solid hardwood lumber. Drawer bottoms and rear panels to be 1/4" plywood or tempered hardboard.
- D. Refer to Section 015721 for VOC requirements.
- E. See Section 123000 for Laboratory Casework requirements.

END OF SECTION

071000- DAMPPROOFING AND WATERPROOFING

1.01 General

- A. Sheet membrane waterproofing systems such as Grace Products systems are preferred over troweled mastic systems. Include geotextile drainage fabric and protection board. Provide positive drainage at the base of building foundation walls below grade.
- B. Extend waterproofing 6 inches above finish grade.
- C. To retard efflorescence, install dampproofing and cap flashing on retaining walls and exterior walls with masonry or stone veneers.
- D. Flexible membrane flashing products as used in masonry construction should be modified asphalt such as Grace Products Vycor Plus or high performance flexible membrane such as Firestone Enverge FlashGard Thru Wall Flashing.

END OF SECTION

072100- THERMAL INSULATION

1.01 General

- A. Levels of insulation should comply with the latest ASHRAE 90.1 requirements.
- B. Minimum R-values are as follows
 1. Roofs
 - a. Low slope roofs: Insulation entirely above deck: LTTR -20 (minimum). Re-roofing may dictate a lower LTTR as appropriate for site and structure. Insulation R values proposed below LTTR-20 requires approval by Georgia Tech Facilities- Design and Construction.
 - b. Metal building roof: R-19
 2. Attic and other: R-38
 3. Walls
 - a. Mass: R-7.6 ci
 - b. Metal Building: R-13
 - c. Steel-Framed: R-13 + R-3.8 ci
 - d. Wood Framed/Other: R-13
 4. Floors
 - a. Mass: R-6.3 ci
 - b. Steel-Joist: R-19
 - c. Wood-Framed/ Other: R-19
 5. Slab on Grade Floors
 - a. Heated: R-10 for 24 in
 6. Opaque Doors
 - a. Swinging U-.0700
 - b. Non-swinging: U-1.450
 7. Vertical Glazing 0-40% of Wall
 - a. Nonmetal framing: U-.065, SHGC 0.25
 - b. Metal framing: U-.060, SHGC 0.25
 - c. Metal framing entrance door: U-.090, SHGC 0.25
 - d. All other metal framing: U-.065, SHGC 0.25
 8. Skylights (assemblies)
 - a. Glass, Class 3 with curb: U-1.17
 - b. Acrylic, Class 3, with curb: U-0.6
 - c. Without curb: U-0.69

- C. The following areas of the building envelope should be sealed, caulked, gasketed or weather- stripped to minimize air leakage:
1. Joints around fenestration and door frames
 2. Junctions between walls and foundations, between walls at building corners, between walls and structural floor or roofs and between walls and roof or wall panels.
 3. Openings at penetrations of utility services through roofs, walls and floors
 4. Site built fenestration and doors
 5. Building assemblies used as ducts or plenums
 6. Joints, seams and penetrations of vapor retarders
 7. All other openings in the building envelope

END OF SECTION

072700 FIRESTOPPING AND SMOKE BARRIER CAULKING

1.01 General

- A. The firestopping caulk shall be a one-part, intumescent, latex elastomer. The caulk shall be capable of expanding a minimum of 3 times at 1000°F. The material shall be thixotropic and be applicable to overhead, vertical and horizontal firestops. The caulk shall be listed by independent test agencies such as UL or FM and be tested to, and pass the criteria of, ASTM E 814 Fire Test, tested under positive pressure. It shall comply with the requirements of the NEC (NFPA-70), BOCA, ICBO, SBCCI and NFPA Code #101.

END OF SECTION

075000 MEMBRANE ROOFING & FLASHING

1.01 General

- A. Low-sloped roofing systems: A premium high temperature TPO roofing system. Adhered systems are required. Firestone Platinum .080 UltraPly TPO over cover board and polyisocyanurate insulation is the basis of design. Consult the Facilities Design & Construction Department at the schematic design phase for design of roofing system and related roof accessories.
- B. The Board of Regents Building Project Procedure Manual, Appendix 6 A, under Roofing Systems indicates that use of single ply roofing requires the approval by the Board of Regents Vice Chancellor for Facilities. Georgia Tech Facilities - Design & Construction may administer the approval process on behalf of the project.
- C. Warranty: Specify that the manufacturer must provide a thirty (30) year “no dollar limit (NDL)” warranty for the installed roofing system upon completion of manufacturer’s printed warranty procedures by the installing contractor. Warranty shall include unlimited coverage for accidental and incidental puncture, is not limited to temperature or U.V. exposure and includes membranes, edge metals and copings, flashings, insulations, attachment products and workmanship to install all of the system including workmanship regardless of applicator’s adherence to manufacturer’s details and specifications.
- D. Insulation Board: Polyisocyanurate insulation. The manufacturer of the roofing system must also supply the insulation and include the insulation in the warranty. Cover boards are required in all modified roofing systems and in adhered, non-fleece backed applications. The minimum acceptable density of the cover board is 120 psi and the cover board must be supplied by, and included in the warranty of, the roofing system manufacturer. Basis of design: ½” IsoGard HD by Firestone Building Products and/or ¼” Georgia Pacific DensDeck Prime.
- E. Stone, precast concrete or metal coping systems require a complete flashing system protecting the wall beneath them. Flash the roof side of parapet walls full height.
- F. Roof mounted equipment should comply with recommended details of the National Roofing Contractors Association “Handbook of Accepted Roofing Knowledge”. Equipment shall be installed in a manner as to comply with, and not void, the roofing manufacturer’s warranty requirements. Roofs with consideration for planned installations of garden roofing or photovoltaic roofing within 7 years shall be installed as to accept those installations without voiding the roofing warranty. Basis of design: Firestone Red Shield EnviroReady Roofing Warranty.
- G. Fume hood fans, motor starters and other roof mounted equipment should be installed on fully flashed raised curbs without the use of pitch pans. When roof mounted equipment cannot be set on curbs, allow 18 inches clearance minimum to facilitate repairs and reroofing. Insulated lines shall always come through a hood or a sleeve. Avoid the use of pitch pans.
- H. Where the existing stone or precast concrete is to remain for aesthetic (architectural) compliance, water-proofing is acceptable with a solvent-free, fleece-reinforced and liquid- applied waterproofing system, based on polyurethane resin. The recommended product is Kemper 2K PUR non-VOC system.

- I. All roof hatches (new or existing) shall incorporate safety rail systems and shall be installed at time of roofing or re-roofing by the installing roofing contractor. Basis of design: SafePro.
- J. All new roof systems shall include a plaque that identifies the roof system manufacturer for warranty information including company name, street address, warranty email address and telephone number. The plaque shall encourage the building manager to contact the roof system manufacturer upon discovery of roof problems to meet warranty notification requirements. (Typically, the roof system manufacturer will contact the roof installer with a work order for repairs.) The length of the warranty shall be expressed in years and start/ end date. The installing contractor's company name, street address, and telephone number shall be identified. The plaque shall be .080 GA aluminum sheet with UV Fade-Resistant Ink. Provide one placard (full size- approx. 16" x 16") for exterior mounting near roof hatch and one half size version for mounting inside roof hatch on curb.
- K. For projects in the Historic District where the existing roofing is slate, an acceptable alternative is CertainTeed Grand Manor Shingle (or equal) fiberglass asphalt shingles. Color to be either Colonial Slate, Gatehouse Slate or Stonegate Gray, whichever best accommodates the project palette.
- L. Use roofing materials with a solar reflectance index (SRI) equal to or greater than 78 for roofs with a slope less than or equal to 2:12 and 29 for roofs with a slope greater than 2:12 for 75% of the roof. Tan membrane may be used where aesthetics deem it necessary. (Prior approval from Georgia Tech Facilities- Design & Construction is required for membrane installations that are not white in color.) Alternatively, install a vegetative roof that covers 50% or more of the roof area and is included in the roofing system manufacturer's warranty, or a combination of the two.
- M. See Section 072100 for thermal protection requirements.

END OF SECTION

081000 DOORS

1.01 General

- A. Doors and door hardware should be considered as a system and are to provide security and comply with life safety and ADA requirements.
 - 1. All exterior doors to have electric strikes, and the main entrances doors to have card readers. All strikes shall be in the locked mode during a power failure. All doors equipped with card readers shall be programmed to be unlocked during business hours from 7:00 AM to 6:00 PM, and locked all other times. For electric strike and card reader specifications see Section 16740 of the Engineering Design Standards of this manual. Review function of all building entrance doors for security, accessibility code and life safety application. All exterior doors shall also be equipped with fire exit hardware as required by the Building Code. Under no cases shall magnetic holding devices be used.
- B. Building perimeter security access costs are incorporated and funded centrally within any facility construction budget or remodeling budget as appropriate for programs/units to be housed in the facility. Some systems may be zoned as necessary for end users.
- C. Review and verify all lock function types with Facilities Office. In general, provide office lock function for offices and laboratories, classroom lock function for classrooms and storeroom lock function for custodial, data, mechanical and electrical rooms.
- D. All building entrance doors to close against a full-length jamb at the strike. Double doors to have a center post mullion. Doors in gang sets are preferred and should swing in parallel. Provide well designed, strong metal pull handles for exterior entrance doors. Do not provide lever handles at entrance doors as they are prone to sagging and are subject to abuse and vandalism.
- E. Aluminum entrance doors such as Kawneer 500 Series Doors or equal must have 5 inch styles (minimum) to receive door mounted closer. Rails containing strikes that adjoin sidelights must be horizontally braced with an intermediate horizontal style. Width should be scaled according to height.
- F. Doors to receive electric strikes and card readers to be pre-wired from strike/reader to ceiling plenum at each public entrance door group. Provide complete card reader system when required in program.
- G. Wood corridor exit doors to be fitted with half mortise hinges to sustain heavy use.
- H. Door sealing gaskets are required on mechanical room doors opening off of public corridors.
- I. Stair doors leading to roofs are to be secured. Provide double cylinder deadbolt locks. Code variances may be a consideration especially in cases of buildings exceeding three stories. Consider code safety, building security and restricted access to roof areas.
- J. Wood doors to receive transparent or solid stain grade finish are preferred to be red or white oak with plain sliced veneers. This assures that matching doors will be available for alterations. Premium Birch and Maple are acceptable stain grade veneers.

- K. Primary entrance doors should be greater than 36 inches wide up to 42 inches but not greater than 8' - 0" tall. Interior door sizes are typically 3' - 0" x 7' - 0" or match existing building standard. Interior door heights over 8 ft. are discouraged.
- L. Laboratory door entrances require specific design criteria, and must be reviewed and approved by the Office of Facilities. A single door of width greater than 36 inches is preferred to paired or unequal paired doors.
- M. See Section 072100 for thermal protection requirements.
- N. See Section 015721 for Indoor Air Quality requirements.
- O. In order to ensure compatibility of the existing campus-wide electronic door control system, all new entrance doors shall be configured to that system. Coordinate requirements and installation with Facilities-Design and Construction.

END OF SECTION

085000 WINDOWS

1.01 General

- A. Consult with Facilities-Design and Construction regarding window design and specification. Vision glass with Low-E coating is preferred. Exterior wall offices should have operable windows to comply with 2010 ADA standards, chapter 2 – section 229, or a mix of fixed and operable panels. Laboratory windows are normally fixed. Double hung, hopper and casement operating windows are acceptable.
- B. To complement the building design, metal windows may be finished with baked on enamel paint or other durable coating system.
- C. See Section 072100 for thermal protection requirements.

END OF SECTION

087000 DOOR HARDWARE

1.01 General:

- A. Hardware to comply with 2010 ADA Standards, chapter 3 – section 309.4 and Georgia Accessibility Code.
- B. Mortise locksets to have all metal components.
- C. Hardware finish to be US 32D Satin Stainless Steel or US 4 Brass for traditional jobs. Other finishes require prior approval. Renovation work to match existing building standard, except upgrade to ADA standards.
- D. Cylinders for all locks to be equal to Best 1E74 X PAT as provided by lock hardware manufacturer. Cylinders for office, classroom and laboratory doors must accept best patented 7-pin cores, the standard established by the Georgia Tech Facilities Lockshop. Cylinders for custodial, data, mechanical and electrical rooms must accept Best standard cores.
- E. Best Access Systems to develop the initial key schedule in coordination with the Georgia Tech Facilities Lockshop and building occupant representative, and to give the final key schedule to the Georgia Tech Facilities Lockshop.
- F. Best Access Systems to cut keys, inscribe each key and permanent core with code of lock that identifies cylinder manufacturer's key symbol, and inscribe each key with sequential key number and the notation A "DO NOT DUPLICATE." Provide 3 keys per lock and turn over all keys, permanent cores, and permanent core control keys to the Georgia Tech Facilities Lockshop.
- G. For renovations, the Georgia Tech Facilities Lockshop will install a maximum of five permanent cores. For more than five and for new construction, Best Access Systems will install the permanent cores.
- H. Exit hardware to be equivalent to Von Duprin, series 99, Dorma series 9000 or Precision series 1100. Surface mount rim set devices latching into center post mullion. Avoid surface or flush bolts on double doors. Renovation work to match manufacturer of existing building standard.
- I. Center post mullion to be equivalent to Von Duprin with stabilizer. Where removable mullions are used, provide locks.
- J. All entrance doors to have a continuous hinge with matching finish and color.
- K. Door closers to be equivalent to LCN #4041, Ryobi # D-3550 or D-3551 or Dorma # 8900. Mount closers on the door, not on the frame. Aluminum entrance doors to be wide stile to receive the closer. Closers for wood doors must be through-bolted.
- L. For doors required to be accessible to the disabled, provide power operators by LCN, Dor- O-Matic or Horton. Automatic and power-assisted doors to comply with 2010 ADA standards, chapter 4 – section 404:
 - 1. Full-powered automatic doors to comply with ANSI/BHMA A156.10.
 - 2. Low-energy and power-assisted doors to comply with ANSI/BHMA A156.19 (1997 or 2002 editions).
- M. Contractor is to save all loose hardware parts and return these to the Georgia Tech Facilities Lockshop at project closeout.

END OF SECTION

092000 GYPSUM BOARD ASSEMBLIES

1.01 General:

- A. Interior Wall Partitions: Specify wall types on drawings to be 20 gage metals studs 3 5/8" o.c. or at 16" o.c. with 5/8" gypsum board both sides. The gage of metal on noted drawings must supersede ASTM C754 for metal gage criteria. Specify the maximum deflection criterial to be L/240 at 5 psi.
- B. Interior Wall Partitions – Acceptable: 25 gage metal studs 3 5/8" at 16" o.c. with 5/8" gypsum board both sides.
- C. Wall Blocking: 20 gage Metal strap across face of metal studs with detail elevations to dimension locations. Wood blocking using solid FR lumber as well as FR plywood is also acceptable.
- D. Gypsum walls enclosing a CMU or solid exterior wall surface should be detailed as framed construction, not furring, using 3 5/8" metal studs, to facilitate power, data communication and future rewiring. Brace studs to primary wall structure for stiffness. Detail concrete column enclosures to accommodate power and data communications systems.
- E. In new construction, extend room partitions at minimum 6" above the reference ceiling line. Stud framing extended to structure is usually appropriate for stability. Provide sound insulation batts for sound control within walls around offices, conference rooms, rest rooms and all sound sensitive areas.
- F. Renovations with infill walls of limited scope may allow for the grid to remain and new walls to extend to the underside of the grid. In these examples, trip the top edge of gypsum board partition with ceiling system "L" trim, white finish.
- G. Design and specify wall types to comply with the International Building Code (IBC) NFPA and UL Fire Resistance Directory. Specify applicable ASTM, Gypsum Association requirements to the best practices and these guidelines.

END OF SECTION

094000 CEILINGS

1.01 Acoustical Ceilings

- A. Lay-in Acoustical Tile Ceiling System
 - 1. Renovation Work: New acoustical tile ceiling systems installed in existing buildings shall match adjacent acoustical tile ceiling system. Verify grid and tile types with Project Manager.
 - 2. Suspension Systems: Standard suspension is 24" x 24" x 15/16" wide intermediate duty standard white finish. In new building construction a 24" x 24" x 9/16" wide intermediate duty standard white finish may be used.
 - 3. Ceiling Tile: Standard ceiling tile shall be 24" x 24" x 3/4" thick, white tegular edge design equal to Armstrong Ultima.
 - 4. Special Conditions: If higher NRC and CAC requirements are required, review ceiling tile options with Design & Construction.
- B. General Guidelines
 - 1. Do not specify concealed grid systems or similar products that are difficult to access.
 - 2. For unconditioned spaces use hot dipped galvanized or aluminum grid suspension systems. Ceiling tile to be equal to Armstrong Fine Fissured Ceramaguard with hold down clips.
 - 3. Provide grid starting points to establish ceiling tile layout.
 - 4. Provide dimensions for light fixtures and other critical ceiling components not centered on the ceiling tile in both directions.

END OF SECTION

096000 FLOORING

1.01 General:

- A. Flooring to comply with 2010 ADA standards, chapter 3.
- B. Corridors, offices and classrooms to be finished with the following carpet, which should comply with the VOC standards in Section 015721 and 2010 ADA standards, chapter 3 – Section 302.2. A palette of materials must be presented to the campus interior designer before presenting to the client.
 - 1. Broadloom Carpet Products:
 - a. Level loop or multi-level loop
 - b. Solution-dyed nylon fiber type 6 or 6.6 is preferred
 - c. Install carpet direct glue down
 - 2. Carpet Tile Products:
 - a. Level loop or multi-level loop
 - b. Solution-dyed nylon fiber type 6 or 6.6 is preferred
 - c. Releasable glue system should be specified. Direct glue down not acceptable.
- C. Rubber wall base to be continuous roll 4" cove base or straight base is preferred. Selection must be approved by the campus interior designer in Facilities.
- D. Transition strips to be rubber. Do not specify metal.
- E. Kitchens and wet utility (custodial) areas to be finished with quarry tile, heavy duty seamless flooring or high performance architectural coating (epoxy resin).
- F. Mechanical, electrical and data communication rooms to be finished with high performance architectural coating, and may be a lower cost alternative for some wet utility areas where quarry tile flooring is specified.
- G. Toilet and rest rooms to be finished with porcelain or ceramic tile on the floor, base and full height on wet walls (showers, etc.). Provide one floor drain in each room.
- H. Laboratories to be finished with heavy duty high quality seamless flooring, integral base is preferred if applicable. Base to be continuous roll 4" cove base.
- I. Dry utility areas (closets, store rooms, file rooms, etc.) to be finished with sealed Concrete. Base to be continuous roll 4" cove base.
- J. Hard flooring systems (such as terrazzo) or high quality seamless flooring may be considered for main lobbies, atriums or where appropriate. Prior approval by the Facilities-Design and Construction is required.
- K. Stairs, including fire exit stairs, may be finished with premium grade rubber treads. Compatible sheet rubber flooring may be used on landings. Risers may be painted. Product should be easily maintained with a dry cloth/mop.
- L. Raised computer room access floors must be clean and dust free under the access floor system. Specify a clear concrete sealer on concrete floors under access floors.
- M. See Section 015721 for VOC requirements.

END OF SECTION

096900 ACCESS FLOORING

1.01 General

- A. Design Loads
 - 1. Concentrated Load: 1250 lbs.
 - 2. Uniform Load: 300 lbs.
 - 3. Ultimate Load: 3850 lbs.
- B. Rolling Loads:
 - 1. 10 passes: 1000 lbs.
 - 2. 100 passes 800 lbs.
 - 3. Impact Load: 150 lbs.
- C. Permanent deflection: 0.010" at design load.
- D. System
 - 1. Floor panels:
 - a. 24" by 24" fully welded steel panels with die formed domes/embossments (60 count minimum) and filled with concrete.
 - b. Edge trim shall top set rigid vinyl trim mechanically locked and glued to the panel top.
 - c. Panel covering: High Pressure Laminate (HPL), Grade HW, 1/16" thick.
 - 2. Pedestals:
 - a. Welded steel with die-formed steel or aluminum cap, designed to receive bolted stringers.
 - b. Adjustability: Vertically adjustable pedestals, adjustment range of 2" minimum. Provide vibration proof mechanism for making and holding fine adjustments in height
 - c. Base: Steel or aluminum base plate providing minimum 16 sq. in. bearing surface.
 - d. Pedestal adhesive: Manufacturer's standard product.
 - 3. Stringers:
 - a. Provide bolted stringers utilizing four bolts per pedestal
 - b. Modular galvanized steel system with 4'-0" stringers.
 - c. Stringers to be set in basket weave pattern.
 - d. Stringers shall be capable of supporting a 550 lb. point load at center span with a permanent deflection of no more than 0.010".
 - 4. Perforated panels: Load-bearing, perforated panels, meeting design requirements
 - a. No less than 25% free area for air flow

5. Accessories:
 - a. Ramps/Stair Units: Access flooring manufacturer's standard components intended for use with the access floor system specified.
 - b. Handrail System: Access flooring manufacturer's standard handrail/guardrail assemblies to comply with 2010 ADA standards for Accessible Design.
 - c. Fascia Assembly: Access flooring manufacturer's standard, designed so that open areas of the access floor system are enclosed.
 - d. Cutouts: Panel manufacturer's standard trim
 - e. Panel lifting device: Provide one (1) suction cup type device for Owner's use.
6. Fabrication
 - a. Acceptable tolerances:
 1. Panel flatness: ± 0.020 " in diagonal measurement.
 2. Panel length: ± 0.020 ".
 3. Panel squareness: ± 0.020 " in length.

END OF SECTION

099000 PAINTS AND COATINGS

1.01 General:

- A. The coating for all exterior metal for Georgia Tech buildings (window frames, door frames, storefront framing, curtain wall framing, coping, gutters, down spouts, etc.) to be equivalent to Sherwin-Williams/Duron Industrial Coating, Satin Bronzestone color. Primer to be equivalent to Sherwin-Williams/Duron Pro Cryl Universal Primer.
- B. All paint color selections to be reviewed and approved by the Office of Facilities. Limit the number of different colors to facilitate future maintenance.
- C. Interior walls to have light value colors and have a latex eggshell or satin finish. Flat finishes are discouraged, particularly in high traffic areas. Special coating systems (Zolatone, etc.) are not preferred and will require prior approval from the Office of Facilities.
- D. Special coating systems for high traffic walls is preferred over vinyl wall covering.
- E. Wood substrates to be finished with Sherwin-Williams/Duron Exterior Oil Based Primer and 2 coats of Resilience Gloss or corresponding equivalents.
- F. Metal substrates to be finished with Sherwin-Williams Pro Cryl Universal Primer and a top coat of Pro Industrial Urethane, Pro Industrial Performance Acrylic Gloss, Sher Cryl Gloss or corresponding equivalents.
- G. Previously painted masonry substrates to be finished with Sherwin-Williams/Duron Loxon Masonry primer and two top coats of Resilience Gloss, or corresponding equivalent.
- H. New masonry substrates to be finished with Sherwin-Williams/Duron Loxon XP Waterproofing Coating or corresponding equivalent.
- I. Per the Building Code requirements, all wall covering to be Type II fabrics and must meet all smoke and flame speed requirements.
- J. All paints and coatings shall comply with the VOC requirements set forth in Section 015721.

END OF SECTION

101100 VISUAL DISPLAY BOARDS

1.01 Visual Display Boards:

- A. Material – PolyVision’s *e³ environmental ceramicsteel* with Forever Warranty™.
 - 1. Forever Warranty warrants ceramicsteel surfaces for as long as they are installed and in use, or forever, whichever occurs first.
 - 2. Certified Cradle to CradleSM Silver certification, a global eco-effective designation, awarded by McDonough Braungart Design Chemistry (MBDC); and SCS Indoor Advantage Gold™ certification, stringent indoor air quality standards of Scientific Certification Systems.
 - 3. Writing surface: *e³ environmental ceramicsteel* 99% recyclable content.
- B. Acceptable manufacturers:
 - 1. Steelcase, Inc.
 - 2. Substitutions requests are to be submitted to the Georgia Tech Facilities Management Design and Construction office for approval.

END OF SECTION

102113 TOILET PARTITIONS

1.01 Toilet Partitions:

- A. Material - High-density Polyethylene (HDPE), 1" minimum in thickness.
- B. Style - Floor mounted overhead braced.
- C. Acceptable manufacturers:
 - 1. Santana Plastic Products
 - 2. Global Products, Inc.
 - 3. Comtec Industries
 - 4. Capitol Partitions, Inc.

END OF SECTION

102116 SHOWER AND DRESSING COMPARTMENTS

1.01 Shower and Dressing Compartments

- A. Comply with the 2010 ADA standards, chapter 6 – section 608
- B. Provide shower and changing facilities in the building or within 200 yards of the building entrance for .05% of FTE (Full Time Employees).

END OF SECTION

102813 TOILET ACCESSORIES

1.01 Toilet Accessories

- A. All toilet accessories including soap dispensers, paper towel dispensers, toilet seat cover dispensers, toilet tissue dispensers and sanitary napkin receptacles will be provided by Georgia Tech Custodial Services and space for installation shall be provided to comply with 2010 ADA standards, chapter 3 – section 309.
1. Soap Dispensers
 - a. Manufacturer: GOJO
 - b. Model No.: FMX-12, Black, 1250ml
 - c. Dimensions: 10”H x 6.25”W x 5”D
 2. Paper Towel Dispensers
 - a. Manufacturer: Tork Elevation Matic
 - b. Model No.: 5510282, Black
 - c. Dimensions: 19.125”H x 13.825W x 8.625”D
 3. Toilet Seat Cover Dispensers
 - a. Manufacturer: Grainger Tough Guy
 - b. Model No. 2VEX8
 - c. 11.5H x 16.25”W x 2.5”D
 4. Toilet Tissue Dispensers
 - a. Manufacturer: Tork Matic
 - b. Model No.: 56TR
 - c. Dimensions: 12”Hx 19.5”W x 5.5”D
 5. Sanitary Napkin Receptacles
 - a. Manufacturer: Grainger Tough Guy
 - b. Model No.: 1ECK9
 - c. Dimensions: 11”H x 9”W x 4 ¼”D

END OF SECTION

104100 INTERIOR SIGNAGE

1.00 General

- A. Refer to Interior Wayfinding Signage Standards at:
<http://www.facilities.gatech.edu/standards-forms>
- B. Refer to Fire Marshal’s Signage Standards at:
<http://www.facilities.gatech.edu/standards-forms>

END OF SECTION

122413 ROLLER SHADES

1.01 General:

- A. Specify roller shades equal to Mecho Shade manual system.
- B. The preferred color will be similar to 0812 charcoal.

END OF SECTION

123000 LABORATORY CASEWORK

1.00 General:

- A. Laboratory casework and fixtures to meet the guidelines of SEFA (Scientific Equipment and Furniture Association)
- B. Casework
 - 1. Quality reference manufacturers:
 - a. Fischer-Hamilton
 - b. Kewanee
- C. Materials:
 - 1. New buildings: Wood Cabinets
- D. Renovations:
 - 1. Typically wood (match the existing cabinets in the building)
 - 2. Face species: White or red oak, plain sliced
 - 3. Fume hood base cabinets:
 - a. Material: Metal (Typically provide 2 base cabinets)
 - b. One acid storage
 - c. One flammable liquids storage vented through fume hood
- E. Glass:
 - 1. Framed sliding and swinging doors: 1/8" float glass.
 - 2. Unframed sliding doors: 7/32" float glass.
 - 3. Fume hoods or other hazardous locations: 7/32" laminated safety float glass
 - 4. Glass shielding for fluorescent lights in fume hoods: tempered glass
 - 5. Provide removable backs for base cabinet cupboards and sink base cabinets
- F. Cabinet Hardware:
 - 1. Pulls: loop style with 4" centers
 - 2. Pulls are mounted horizontally on drawers and vertically on doors
 - 3. Manufacture from brushed or anodized aluminum, or satin finish stainless steel
- G. Hinges: Five knuckle institutional hinges, satin finish stainless steel
- H. Drawer slides
 - 1. Drawer slides shall be rated at 100 pounds minimum.
 - 2. They shall consist of two steel epoxy coated sections providing a quiet, smooth operation on nylon rollers. Case channels shall maintain alignment of drawer.
 - 3. Slides shall wrap under drawer sides for additional support.
 - 4. The drawer shall be removable without the use of tools.
 - 5. Provide 150 lb. capacity drawer slides for file drawers.

- I. Catches:
 - 1. Provide roller catches on swinging doors.
 - 2. Spring-loaded polyethylene roller with a steel strike plate
 - 3. Provide elbow catches and strike plates on left hand doors of double door cases.
 - 4. Steel, spring type
- J. Locks and Number Plates:
 - 1. Provide locks for cabinets only as required by individual project
 - a. Provide National Lock Remove-A-Core 5-disc tumbler, heavy duty cylinder type. Exposed lock noses shall be dull nickel (satin) plated and stamped with identifying numbers.
 - 2. Provide number plates only as required by individual project
 - a. Number plates shall be aluminum or stainless steel, screw attached type with satin finish and indented black lettering.
- K. Lab Tops:
 - 1. Chemical labs:
 - a. Epoxy resin, 1"thick.
- L. Quality reference manufacturers:
 - 1. Epoxyn Products
 - 2. Durcon
 - 3. Color: Black
- M. Biology & clinical labs:
 - 1. Trespa, 1"thick
 - 2. Quality reference manufacturer: Trespa North America, Limited
- N. Provide marine edge tops at sinks
- O. Provide 4" tall matching side and back splashes
- P. Lab Shelving
 - 1. Shelves: 1"thick AA plywood Oak veneer with hardwood edge banding
 - a. Typically make shelves 12" deep
 - 2. Standards: Unistrut P3300 channel, 1 5/8" X 7/8"
 - 3. Brackets: Unistrut P2491 through P2503
 - a. Typically P2493 bracket 10" long
 - b. Size brackets 2" less than shelf depth
 - 4. Screw shelves to standards

Q. Sinks:

1. The term sinks refers to all sinks, except cup sinks
2. Sinks: Under counter epoxy resin sinks with supports
3. Cup sinks: Polyolefin oval cup sink
4. Where dictated by the individual application, provide drop-in stainless steel sinks
5. Provide polyolefin outlets, tailpieces, traps, etc.
 - a. Provide similar item in stainless steel when used with stainless steel sinks
6. Provide overflow accessory for sinks

R. Laboratory Pegboards: (Drainboards)

1. Provide pegboards at all sinks
2. Board: Epoxy resin board finished on face and edges. Where exposed, finish back with slightly different surface texture and bevel bottom edges.
3. Pegs: Polypropylene pegs in 4 3/4" (+/- 1/2") length, with glassware protector base. Base of pegs shall be two prong style for mechanical attachment. Do not bond pegs to board.
4. Drip Trough: Provide stainless steel drip trough with integral drain outlet that are the same width as the pegboards with which they are associated. Provide 36" (min) PVC draw hose.

S. Fixtures:

1. Manufacturer for quality reference: Watersaver
2. Sink faucets:
 - a. Mixing valve swivel gooseneck with vacuum breaker
 - b. Provide aerator and serrated tip for all faucets
3. Cup sink faucets:
 - a. Single valve facet with fixed gooseneck and vacuum breaker
 - b. Provide CW service at cup sinks
 - c. Provide serrated tip for cup sink faucets

4. Emergency fixtures to comply with 2010 ADA standards, chapter 3 – section 309.
 - a. Eye wash units:
 1. Provide hand held eye wash units. Watersaver or Guardian brands are acceptable.
 2. Provide eye wash units at all sinks
 3. Provide one emergency shower per lab
 4. Finish: Provide chrome plated fixtures
 5. Provide other materials and standard finish where by the nature of the service being delivered, such as deionized water, steel or brass fixtures are not acceptable.

2.01 Service Fittings and Accessories

- A. General: Service fittings to be metal.
 1. Provide laboratory grade service fittings.
- B. Provide removable screw-on type colored plastic discs with letter stamped on disc in contrasting color as scheduled below:

<u>Service</u>	<u>Disc/Letter Colors</u>	<u>Letters</u>
Gas	Blue/White	Gas
Vacuum	Yellow/Black	Vac.
Compressed Air	Orange/White	C-Air
Cold Water	Green/White	CW
Hot Water	Red/White	HW
Steam	Black/White	Stm
Chilled Water	Brown/White	CH
Distilled Water	White/Black	DW

1. Disc color for special services as determined by Owner.
- C. Performance
 1. Maximum Line Pressures:

Ball Valve Cocks (Gas and Air)	75 PSI
Ground Key Cocks (Gas and Air)	40 PSI
Needle Point Cocks (Gas and Air)	65 PSI
Vacuum	28.5" Mercury
Hot and Cold Water	80 PSI
Steam	30 PSI

- D. Electrical fixtures and fittings:
 - 1. Pedestal type meeting the provisions of the current edition of the National Electric Code.
 - 2. Materials: Heavy "Iustrebrite" corrosion resistant aluminum alloy polished to a chrome like color.
- E. Finishes
 - 1. Provide factory finished casework and shelving.
 - 2. Wood: Highly chemical-resistant modified acrylic urethane finish with built in U.V. blocker over stain of selected color. Finish must meet performance characteristics of TR- 5, Section 1500, AWI Architectural Woodwork Quality Standards.
 - 3. Metal: Highly chemical resistant electrostatically applied urethane powder coat, baked in controlled high temperature oven.
 - a. Exterior and interior exposed surfaces: 1.5 mil average and 1.2 mil min.
 - 4. Backs of cabinets and other surfaces not exposed to view: 1.2 mil average.
 - 5. Liquid dipped, solvent based finishes are not acceptable.
 - 6. Finish front and both sides of cabinets
 - 7. All finishes, adhesives, and sealants must comply with the VOC requirements in Section 015721.

END OF SECTION

124800 RUGS AND MATS

1.01 General:

- A. Comply with 2010 ADA Standards, Chapter 3 – section 302.
- B. The preferred entrance mat to be equal to Collins and Aikman Triad Mat System and should be 10 feet long in the primary direction of travel
- C. Prior approval by the Office of Facilities is required.

END OF SECTION

129313 BICYCLE RACKS

1.01 General

- A. Provide secure bicycle racks and/or storage within 200 yards of the building entrance for 5% or more of building users, measured at peak periods.
- B. See Georgia Tech Landscape Design Standards for design requirements
<http://space.gatech.edu/landscape-master-plan>

END OF SECTION

142000 ELEVATORS

1.01 Code Compliance:

- A. ASME A17.1
- B. ADA / ADAG- Latest Edition
- C. Georgia Department of Labor

2.01 General Requirements:

- A. Comply with Georgia Department of Labor laws that regulate elevators. Specify that Contractor is to pay all fees and to coordinate the inspection of the elevator system with the State Elevator Inspector. City of Atlanta is not involved in elevator regulation on the Georgia Tech Campus.
- B. Provide automatic fireman's recall system to meet the current elevator code. If one elevator is modernized or added to a building, all elevators need to have FEOK1 keys installed for Phase 1 and Phase 2 fire service
- C. Provide wiring for telephone communications. Provide ADA compliant GAI Tronics telephone unit and locate incorporated in car station. Georgia Tech Utilities Maintenance (404- 385-6000) will provide model number and specification (see section 273013).
- D. Coordinate floor name convention with approved Floor Plan Conventions, i.e. "GROUND FLOOR".
- E. Provide for administrative building key access to elevator equipment rooms. Program requirements will usually apply and restrict access to equipment rooms. Must be group 2 security by the Elevator Code
- F. Provide sump pump rated at 3000 GPH per elevator with flush mounted metal grate cover plate, 19 Ftc light from 2 fixtures in elevator pit and a fixed access ladder. Provide duplex GFIC utility outlet and single non GFIC outlet for sump pump. Light switch to be located at pit ladder so accessible prior to entering pit.
- G. Provide soft start reduced voltage starting system for hydraulic elevators. Provide AC, VVVF on all new traction elevators and modernized geared machines. Provide DC/SCR drives on modernized gearless machines
- H. Provide Battery Lowering system for all hydraulic elevators on loss of power
- I. Provide Battery Drift function for all traction elevators on loss of power
- J. Size car capacity and door for research activities and building equipment. Consider C1 Class loading on service elevators on a case by case basis.
- K. Provide vandal proof fixtures for pushbuttons on hall stations and lanterns and car stations
- L. Provide LED lighting for all push buttons and elevator cab light assemblies
- M. Provide vegetable oil for all new and modernized hydraulic elevators
- N. Provide steel hoist ropes for all traction elevators
- O. Provide full screen non-contact door detector on all elevators

- P. Direction arrow fixtures at all hall landings, incorporate position indicator on main fire recall floor.
- Q. Locate hoist way access key switch in jamb at top and bottom floor as required or specified.
- R. Provide three sets of neatly bound written information necessary for proper maintenance and adjustment for equipment of within 30 days following final acceptance. Final retention will be withheld until data is received by Purchaser and reviewed. Include the following as minimums:
 - 1. Straight-line wiring diagrams of “as-installed” elevator circuits, with index of location and function of components. Provide one set reproducible master. Mount one set wiring diagrams on panels, racked, or similarly protected, in elevator machine room. Provide remaining set rolled and in a protective drawing tube. Maintain all drawing sets with addition of all subsequent changes. These diagrams are Purchaser’s property. A legend sheet shall be furnished with each set of drawings to provide the following information:
 - 2. Name and symbol of each relay, switch, or other apparatus.
 - a. Location on drawings, drawing sheet number and area, and location of all contacts.
 - b. Location of apparatus, whether on controller or on car.
 - 3. Written Maintenance Control Program (MCP) specifically designed for the equipment included under this contract. Include any unique or product specific procedures or methods required to inspect or test the equipment. In addition, identify weekly, bi- weekly, monthly, quarterly, and annual maintenance procedures, including statutory and other required equipment tests.
 - 4. Printed instructions explaining all operating features.
 - 5. Complete software documentation for all installed equipment.
 - 6. Lubrication instructions, including recommended grade of lubricants.
 - 7. Parts catalogs listing all replaceable parts including Contractor’s identifying numbers and ordering instructions.
 - 8. Four sets of keys for all switches and control features properly tagged and marked.
 - 9. Diagnostic test devices together with all supporting information necessary for interpretation of test data and troubleshooting of elevator system, and performance of routine safety tests.

- S. The elevator installation shall be a design which can be maintained by any licensed elevator maintenance company employing journeymen mechanics, without the need to purchase or lease additional diagnostic devices, special tools, or instructions from the original equipment Manufacturer.
1. Provide onsite capability to diagnose faults to the level of individual circuit boards and individual discreet components for the solid state elevator controller.
 2. Provide a separate, detachable device, or software as required to the Purchaser as part of this installation if the equipment for fault diagnosis is not completely self-contained within the controller. Such device shall be in possession of and become property of the Purchaser. The software or device shall be made available to the Customer in the case of misplacement or loss of the original.
 3. Provide the tools or software for, service, repair and parts replacement.
 4. Installed equipment not meeting this requirement shall be removed and replaced with conforming equipment at no cost to the Purchaser.
 5. Provide upgrades and/or revisions of software during the progress of the work, warranty period and the life of the elevator.
- T. Elevator Cab Finishes: Facilities personnel shall review and approve all proposed finishes. Finishes shall vary by Elevator Use designation. Typical Elevator Use designations are: Administrative Use, Freight Elevator, General Student Use, Lab Use, Special Use (Athletics or Commercial).
1. Cab Entry: The existing front return and transom shall be re-clad with #4 Finished Brushed Stainless Steel. This applies to all Elevator Use designations.
 2. Entrance Sill: Clean and polish existing car door entrance sill. Replace with new aluminum sill if existing sill is warped or damaged. This applies to all Elevator Use designations.
 3. Cab Interiors:
 - a. Administrative Use Elevator: Provide vertical mounted wall panels that are constructed of $\frac{3}{4}$ " thick marine grade plywood. Each panel section shall be faced with 24 gauge/.024"/.61mm #4 Brushed Stainless Steel Finish and framed in 1/16" thick stainless steel. Frame Members shall be separated by $\frac{1}{2}$ " thick #8 Mirrored Stainless Steel metal reveals and fitted with 3 $\frac{1}{2}$ " wide #8 Mirrored Stainless Steel metal plates at corners.
 - b. Freight Elevator: Provide vertical mounted wall panels that are constructed of $\frac{3}{4}$ " thick marine grade plywood. Each panel section shall be faced with 14 Gauge /.075" /1.91mm #5WL Steel Finish and framed in 1/16" thick stainless steel. Frame Members shall be separated by $\frac{1}{2}$ " wide #4 Brushed Stainless Steel metal reveals and fitted with 3 $\frac{1}{2}$ " wide #4 Brushed Stainless Steel metal plates at corners.

- c. General Student Use Elevator: Provide vertical mounted wall panels that are constructed of $\frac{3}{4}$ " thick marine grade plywood. Each panel section shall be faced with 24 gauge/.024"/.61mm #4 Brushed Stainless Steel Finish and framed in 1/16" thick stainless steel. Frame Members shall be separated by $\frac{1}{2}$ " thick #8 Mirrored Stainless Steel metal reveals and fitted with 3 $\frac{1}{2}$ " wide #8 Mirrored Stainless Steel metal plates at corners.
 - d. Lab Use Elevator: Provide vertical mounted wall panels that are constructed of $\frac{3}{4}$ " thick marine grade plywood. Each panel section shall be faced with 18 Gauge /.048" #5WL Steel Finish and framed in 1/16" thick stainless steel. Frame Members shall be separated by $\frac{1}{2}$ " wide #4 Brushed Stainless Steel metal reveals and fitted with 3 $\frac{1}{2}$ " wide #4 Brushed Stainless Steel metal plates at corners.
 - e. Special Use Elevator: Provide vertical mounted wall panels that are constructed of $\frac{3}{4}$ " thick marine grade plywood. Each panel section shall be faced per Design documents.
4. Lighting: Provide low voltage, high efficiency recessed LED down lighting with finished reflector, trim and cover shields. Provide 6 lights minimum per can. Ceiling panels will be mounted in #8 Mirrored Stainless Steel panels. This applies to all Elevator Use designations.
 5. Handrail: Provide standard $\frac{1}{2}$ " x 2" polished #4 Stainless Steel flat stock handrail on rear and side walls with the top of the rail located at 32 inches above the finished floor elevation. Use three (3) points of attachment designed for interior access servicing with exterior support plates. This applies to all Elevator Use designations.
 6. Bumpers: Provide standard $\frac{1}{2}$ " x 4" polished #4 Stainless Steel flat stock bumper rail on rear and side walls with top rail located 6 inches above the finished floor. Use three (3) points of attachment designed for interior access servicing with exterior support plates. This applies to all Elevator Use designations.
 7. Base:
 - a. Administrative Use Elevator: Provide a #8 Mirrored Stainless Steel finished metal base with a $\frac{1}{4}$ " wide continuous vent slot above the base to allow for the proper amount of air to infiltrate the cab based on the CFM of the exhaust fan and the car interior size. Prepare base to accept finished floor material (Tile or Carpet) selected by owner.
 - b. Freight Elevator: Provide a #8 Mirrored Stainless Steel finished metal base with a $\frac{1}{4}$ " wide continuous vent slot above the base to allow for the proper amount of air to infiltrate the cab based on the CFM of the exhaust fan and the car interior size. Prepare base to accept finished floor material - Diamond Plate Steel Matte Finish.

- c. General Student Use Elevator: Provide a #8 Mirrored Stainless Steel finished metal base with a ¼” wide continuous vent slot above the base to allow for the proper amount of air to infiltrate the cab based on the CFM of the exhaust fan and the car interior size. Prepare base to accept finished floor material (LVT, Rubber, or Carpet) selected by owner.
 - d. Lab Use Elevator: Provide a finished metal base with a ¼” wide continuous vent slot above the base to allow for the proper amount of air to infiltrate the cab based on the CFM of the exhaust fan and the car interior size. Prepare base to accept finished floor material – LVT or Diamond Plate Steel Matte Finish selected by owner.
 - e. Special Use Elevator: Provide a finished metal base with a ¼” wide continuous vent slot above the base to allow for the proper amount of air to infiltrate the cab based on the CFM of the exhaust fan and the car interior size. Prepare base to accept finished floor material (Tile, LVT or Carpet) selected by owner.
8. Flooring: Provide finish floor covering selected by owner.
- a. Administrative Use Elevator: Tile or Carpet
 - b. Freight Elevator: Diamond Plate Steel Matte Finish
 - c. General Student Use Elevator: LVT, Rubber, or Carpet
 - d. Lab Use Elevator: LVT or Diamond Plate Steel Matte Finish
 - e. Special Use Elevator: Per Design
9. Cab Exterior: Apply furniture steel (primed or finished steel) to shaft side of panels to prevent warping or other deformations. This applies to all Elevator Use designations.
10. Cab Door: Standard 1” thick, 14 gauge/.075”/ 1.91mm hollow metal flush construction, reinforced for power operation and insulated for sound deadening. Paint shaft side of doors black and face of cab side with 16 gauge/.060”/1.52mm #4 Brushed Stainless Steel. The doors shall have no binder angles. All welds to be continuous, ground smooth and invisible. Drill and reinforce doors for installation of door operator hardware, door protective device, door gibs, etc. This applies to all Elevator Use designations.

END OF SECTION

221116 PLUMBING PIPING

1.01 General

- A. Building domestic water supply lines shall have a pressure regulating device.
- B. All underground hot and cold water supply (including all risers) shall be type “K” copper pipe. Domestic water piping above ground may be type “L”.
- C. Where domestic water system provides intake water to other systems, these systems shall have a positive anti-back-flow device. Provide a backflow preventer for each make-up water supply as per the Georgia State Minimum Standard Plumbing Code. Main building service shall be separated from the city service by an RPZ type backflow preventer.
- D. A cut-off valve is required on every branch that leads from a main or major piping system in the building. Cut-off valve shall be located where it can be easily reached and serviced.
- E. In Chemistry or related buildings, main concealed drain lines should be chemical resistant. Under concrete slabs and through foundations, hub and spigot DURIRON should be used.
- F. Lead for any drain lines is not acceptable.
- G. For laboratory casework, chemical resistant joints, heat fusion polypropylene, PVDF or glass is acceptable. The compatibility of the selected materials should be reviewed with the chemicals and concentrations that are intend to be carried. Lead is unacceptable. For troughs, sinks, etc., in laboratory casework, chemical resistant polypropylene is preferred.
- H. All outside spigots should have Ano-freeze@valves. Outside spigots should be spaced every 200 feet and on all sides of buildings.
- I. Valves should have removable seats and washers if at all possible, including those on laboratory casework.
- J. Provide floor drains with trap primers in all mechanical rooms located to allow easy access for cleaning. Do not locate drains under any mechanical equipment.
- K. Water supply lines and connection for fire service shall be separate from the domestic water supply and connections.
- L. An instantaneous heat exchanger (steam/hot water) shall be used in dormitory application for domestic hot water in lieu of storage tank. Provide a recirculating pump.
- M. In a large 24-hour facility that has its own chiller, consider heat recovery from the condenser side for preheating hot water.
- N. When renovating existing sprinkler piping in a building, remove all existing exposed piping that will be abandoned, if any, and cap all underground piping that will be abandoned, if any.
- O. When new piping is installed in a building with finished spaces, the piping shall be leak tested first with air at no greater than 40psig. Once passing the air test, a subsequent hydrostatic test shall be used to further validate the system. Hydrostatic testing shall be at 1 ½ times working pressure for at least four hours.

END OF SECTION

224000 PLUMBING FIXTURES

1.01 General

BUILDING TYPE	TYPE of FIXTURE or EQUIPMENT	WATER USAGE (GALLONS/USE)
Academic, Other research, Athletics, Non-residential Buildings	Public bathroom faucets	0.5 gpm aerator, sensor operated
Student Dorm, residential, Academic, Other research, Athletics	Residential faucets	0.5 gpm aerator, sensor operated
Café, Cafeteria, Large & Small Kitchens,	Kitchen faucets	2.2 gpm
Student Dorm, residential, Academic, Other Research, Athletics	Toilets	1.28 gallon per flush, sensor operated
Student Dorm, Academic Other Research, Athletics	Urinals	0.125 gpf, sensor operated
Student Dorm, Residential, Academic, Other Research, Athletics	Showerheads	1.0 gpm (need to specify building water pressure before ordering; tamper resistant, e.g., BriCor)
Student Dorm, Residential, Academic, Other Research, Athletics	Clothes Washing Machines	15 gals/load
Student Dorm, Residential, Academic, Other Research, Athletics	Dishwashers	4-8 gals/load
Café, Cafeteria, large kitchen	Pre-rinse nozzles need to pass Food Service Tech Center certification (FSTC)	1.15 gpm (must be tested by FSTC)
Café, Cafeteria, large kitchen	Food Steamers need to pass Food Service Tech Center certification (FSTC)	Use recirculating steam to heat steamers, also called "boilerless steamers". Steamers must be tested by FSTC, use < 2 gals/hr
Café, Cafeteria, large kitchen , Ice machines	Café, Cafeteria, large kitchen Ice machines; need to pass Food Service Tech Center certification (FSTC)	Once-through tap water cooling prohibited; Use re-circulating closed-loop chilled water or air

Café, Cafeteria, large kitchen	Commercial, industrial dishwashers	Maximum of 1 gallon per rack. Retrofit of nozzles to be efficient - Use Optirinse (Hobart) or comparable
Academic, Other Research	House vacuum system: liquid ring (wet) vs. dry vacuum pumps	Use dry vacuum pumps
Academic, Other Research	Glass ware washers	Purchase efficient units, such as HAMO brand
Academic, Other Research	Lasers, electron microscopes, or other research equipment needing cooling	Use re-circulating closed-loop condenser water for cooling. Once-through tap or chilled water cooling prohibited.
Academic, Other Research	Autoclaves, sterilizers: without mizers vs. with mizers	Install water mizers. Quench water runs only when >140 F wash wastewater detected (typically <6 hrs per day). If available, use recycled water for quenching.
Academic, Other Research	Reverse Osmosis/water treatment system standard 50% efficiency vs.with reuse of reject water	Capture RO reject water for non-potable re-use. RO reject water could be used for non-potable uses, e.g., quenching, toilet flushing, sewer trap priming

END OF SECTION

224700 DRINKING FOUNTAINS AND WATER COOLERS

1.01 General

- A. The basis of design for filtered bottle filling stations with bi-level ADA compliant design will be Elkay LZSTL8WSSK.

END OF SECTION

230001 Mechanical - General and Design

1.01 Mechanical Codes:

- A. All mechanical installation shall be designed and installed in compliance with State of Georgia Construction Codes. Those Georgia Codes governing mechanical installations are:
1. Georgia State Minimum Standard Building Code
 2. Georgia State Minimum Standard Gas Code
 3. Georgia State Minimum Standard Plumbing Code
 4. Georgia State Minimum Standard Mechanical Code
 5. Georgia State Minimum Standard Energy Code
 6. Georgia State Minimum Electrical Code
 7. City of Atlanta, Water Bureau
 8. Georgia SB 130 – Energy Efficiency and Sustainable Construction Act of 2008
- B. Explicit reference to the date of the most recent edition of a code should be made in the project design criteria. Most current requirements can be found at:
<http://www.dca.state.ga.us/development/constructioncodes/program/codes2.asp>
- C. Standards for design and installation of mechanical system components established by various societies, councils, and associations should be used for additional guidance. Among those to be considered are:
1. SMACNA
 2. ASHRAE
 3. American Council of Governmental Industrial Hygienist
 4. ANSI
 5. ASTM
 6. N.F.P.A.
- D. Design heating, ventilating, and air conditioning (HVAC) systems to meet the requirements of ASHRAE Standard 55-2010, Thermal Environmental Conditions for Human Occupancy. Agree to conduct a thermal comfort survey of building occupants within 6 to 18 months after occupancy. Agree to develop a plan of corrective action if the survey results indicate that more than 20% of occupants are dissatisfied with thermal comfort in the building.
- E. Design HVAC systems to meet the requirements of ASHRAE 90.1 2010. Provide demand controlled ventilation strategies in compliance with current Energy Codes and for any space with an occupancy of 10 or more people.
- F. The state of Georgia currently requires that buildings be designed in compliance with ASHRAE 90.1 2007, It is Georgia Tech's desire to exceed these minimum requirements. As such, designers shall make every effort to comply with ASHRAE 90.1 2010. Consult with Georgia Tech Facilities Design and Construction where a waiver to such compliance is desired.

- G. All mechanical system components shall be the manufacturers' standard commercial product. A standard commercial product is a product that has been sold for a period of at least three years on the commercial market through advertisements, manufacturer's catalogs or brochures, and represents the latest production models. The products shall have proven successful field experience which involved operation or use under conditions equivalent to those of the project on which they are applied for the same three- year period.
- H. Application: These criteria apply to all facilities administered by the Board of Regents regardless of size or origin of project and source of funds.
- I. Design Responsibility: Responsibility for project design resides solely with the Board of Regents. The Construction and Office of Facilities or the Chancellor's staff, supervises and administers project preparation for contracting as a service to the individual institutions.
- J. Design Policy: The mechanical system will be considered an essential element of each building with adequate space allocated for it and in a manner that will permit the installation of a well-designed system capable of being operated and maintained with minimum expenditure of physical plant power.

1.02 System Evaluation

- A. System designs shall be evaluated by the design team on the basis of total owning and operating cost over a twenty (20) year period, not energy or capital cost alone. Life Cycle Cost Analysis vs. construction cost shall be compared and presented to Georgia Tech for evaluation.
- B. Simple systems requiring the least number of mechanical components and controls are preferred where possible if long term cost is affected minimally.
- C. Optimum reliability, will determine the quality and number or components used.
- D. Submission of owning and operating cost analysis by architect/engineer will be required at the 50 percent Design Review Period for approval by the Facilities Engineering Department. During review design should proceed.

1.03 Equipment

- A. All Equipment will be new, be of the latest design and best quality available for the application, and be inspected prior to delivery to the job site to assure freedom from defects in workmanship and materials.
- B. All equipment and products specified and installed will be standard items of production having not less than three (3) years' proven successful field experience which involved operation or usage under conditions equivalent to those of the project on which they are applied.
- C. All equipment will be applied and installed strictly in accordance with manufacturers' recommendation.
- D. All equipment must be accessible and meet the manufacturer's installation requirements for accessibility and service. This includes but is not limited to all filters, motors, electric controls and drain pans.
- E. Install the center of Fan Coil Units and other terminal equipment no more than 2 foot above the suspended ceiling.

- F. Routing of cabling to support mechanical equipment must be well planned. Cabling shall be supported by its own support system and shall not be supported from other equipment or ceiling grid materials. Cabling shall be routed along building lines.

2.01 Electrical Codes:

- A. All electrical installations and design shall conform to the Edition of the National Electric Code currently adopted by the State of Georgia with Georgia Amendments.
- B. All electrical installations and designs shall conform to the latest Georgia State Energy Code for Buildings.

3.01 Equipment Exceptions:

- A. Requests for exceptions to these criteria shall be submitted to Georgia Tech's Office of Facilities Engineering Department for approval. Upon approval, forward the request to the Vice-Chancellor, Construction & Plant Operations, Regents of the University System of Georgia, Atlanta, Georgia for assessment and decision.
- B. Requests for exception shall include:
 - 1. A detailed description of the alternative(s) proposed.
 - 2. Full justification for its (their) use instead of the design designated by these criteria.
 - 3. A list of its (their) benefits to the University System of Georgia with specific statements regarding improved performance, lower owning and operating cost, and greater reliability.
 - 4. Exceptions will apply only to the specific project for which they are granted.

4.01 Piping Identification System:

- A. Piping systems shall be identified clearly with fully descriptive identifiers or abbreviations as specified herein.
 - 1. Materials for Color Identification:
 - a. Plastic tape specified herein shall be 3M AScotch® Brand No. 471 vinyl tape, 5 mil thickness, of colors specified. Equal Texcel or Permacel tape is acceptable.
 - 2. All exposed piping shall be painted continuously under another Section of the design criteria the background colors specified hereinafter.
 - 3. All other piping shall have background colors specified hereinafter of 5" wide plastic tape.

4. Locations of Color Identification: Provide color identification in accordance with the schedule specified herein at the following locations:
 - a. All exposed piping:
 1. Within 1' - 6" of each gate, globe, angle, or plug valve.
 2. Within 3' - 0" of each 90 degree elbow, connection to equipment or vessel, point where pipe enters shaft to upper floors, and point where pipe pierces outside wall.
 - b. Above Suspended Ceilings:
 1. Within 1' - 6" of each valve or valve assembly.
 - c. At tees, both main and branch shall be identified within 300" of tee.
 1. Within 3' - 0" of each 90 degree elbow.
 - d. Piping Concealed in Cases or Shafts:
 1. Identify each pipe visible through access door panel.
 2. Flow Markings: Arrows showing the direction of flow should be painted on the piping near the location of each color identification.

B. Schedule of Piping Identification

CLASSIFICATION	BACKGROUND COLOR	IDENTIFICATION
Cold Water	Green	Domestic Cold Water DCW
Domestic Hot Water	Green	Domestic Hot Water DHW
Domestic Hot Water	Green	Domestic Hot Water Return DHWR
Equipment Drains	Green	None
High Pressure Steam	Yellow	High Pressure Steam HPS
Medium Pressure Steam	Yellow	Medium Pressure Steam MPS (note pressure in psi)
Pump Condensate Return	Yellow	Pump Condensate PC

Hot Water Supply – from Converter (Heating)	Yellow	Hot Water Supply HWS
Hot Water Return – from Converter (Heating)	Yellow	Hot Water Return HWR
Steam Vent, Steam Relief, Valve Discharge, etc.	Yellow	Steam Vent
Reduced Pressure Steam	Yellow	Steam
Chilled Water Supply	Blue	Chilled Water Supply
Chilled Water Return	Blue	Chilled Water Return

1. Furnish Color Identification Schedule framed under glass.

5.01 Water Treatment:

- A. Georgia Tech has two professional service contracts in effect for water treatment. One for the Atlanta campus, covers the central steam plant, steam distribution system, central cooling plant and cooling towers, and the chilled water distribution system. The second contract provides service for all local water treatment, i.e., building hot water circulating systems, small cooling tower serving individual buildings, local chilled water circulating systems, and individual building boilers.
- B. There is no domestic water treatment.
- C. The Office of Facilities will supply you with the names of those currently performing these services. The water treatment consultant will provide you with all information for designing the water treatment system so that it will be consistent with the established program. Water treatment is required for piping installed in new buildings prior to connection to Georgia Tech services. The Commissioning Agent shall validate water treatment is performed as part of the flush out and prior to campus connections.

5.02 Campus Steam Distribution System:

- A. Georgia Tech has a steam distribution system. The system and design requirements are covered in Section 232213. The campus steam distribution system shall be used for building heating and other requirements for heating for the area of campus south and east of Ferst Drive. The buildings north and west of Ferst Drive will be served by natural gas and will generate their own heat. Georgia Tech owns its own natural gas distribution system North and West of Ferst Dr. The contractor shall not turn on (start up or engage) the campus steam or natural gas distribution system without the assistance of the Office of Facilities.

5.03 Campus Chilled Water System:

- A. Georgia Tech has a chilled water distribution system. The system design requirements are covered in Section 231113. The contractor shall not turn on (start up or engage) the campus chilled water distribution system without the supervision and assistance of the Office of Facilities. The project will be assessed a chilled water capacity fee of \$950 per ton of cooling.

5.04 Campus Electrical Distribution System:

- A. The contractor shall not make connection to the campus electrical distribution system.

5.05 Sanitary Systems:

- A. All sewage systems must comply with the standards established by the City of Atlanta.
- B. Catch basins for street drainage must comply with standards established by the Georgia Transportation Department and the City of Atlanta.
- C. Storm and sanitary service shall be separate for all Georgia Tech projects to the point of tie in into the City of Atlanta system.

5.06 Campus Water System:

- A. The campus is served by the City of Atlanta. All facility water service connection must comply to the codes and standards of the City of Atlanta.

6.01 Natural Gas:

- A. The majority of campus is served by the Atlanta Gas Light Company. All the major buildings north of Ferst Drive west to 6th Street are served by Georgia Tech Natural Gas lines. All facility natural service connections must comply with the standards of Atlanta Gas Light and the codes and standards of the City of Atlanta. Provide full bypass around the gas meter with test ports to enable validation of the meter. Where meter provides whole building consumption, provide RS485 connectivity to the meter for interface with the Campus Ion Metering System.

END OF SECTION

230002 HVAC- GENERAL AND DESIGN

1.01 General:

- A. In general, the implication of the technical terms used in this section the criteria correspond with the definitions provided in the ASHRAE Handbook of Fundamentals.

2.01 Design Conditions:

- A. The values provided in Chapter 14 of the ASHRAE Handbook of Fundamentals 2013 or as published in ASHRAE 90.1 2010 shall be used for the Georgia location closest to the project under design. Load calculation shall be in conformance with ASHRAE 183-2007 as required by the energy code. Central station base building systems shall be sized to accommodate 15% growth.

3.01 Re-Circulated Air Systems, Atlanta Georgia:

- A. Summer: Outside – 94.0°F dry bulb, 74.3°F wet bulb.
- B. Winter: Outside - 10°F dry bulb, 10 grains/lb. Dry air for calculating humidification.

4.01 100% Outside Air Systems:

- A. Summer: outside – 94.0°F dry bulb, 74.3°F wet bulb.
- B. Winter: Outside - 10°F dry bulb, 10 grains/lb. Dry air for calculating humidification.
- C. Outside design conditions used shall be indicated in the contract documents for record purposes only.

5.01 Indoor Design Temperature

- A. See 230003 Space Conditions.

6.01 Exceptions:

- A. Only process cooling requirements may be exempted from design temperatures, humidification and dehumidification requirements.

7.01 Humidification:

- A. May be provided, but shall be limited to no less than 30% relative humidity in the heating season. Do not use direct humidification with campus steam-generate sanitary steam for humidification. Provide humidification where required by research program requirements and as needed to meet ASHRAE 55. Provide a means for makeup softening on humidification systems. Humidification needs shall be considered where there is a potential for electrical arcing.

8.01 Energy Analysis

- A. Comparison of annual energy usage of the ASHRAE Standard 90.1 Appendix G and/or a proposed alternative building with the system design shall be a detailed permit level evaluation of the effect of:
 - 1. CLIMATE DATA - Coincident hourly data for temperatures, solar radiation, wind, and humidity of typical days in the year representing seasonal variation.
 - 2. BUILDING DATA - Orientation, size, shape, mass, air moisture, and heat transfer characteristics.
 - 3. OPERATIONAL DATA - Temperature, humidity, ventilation illumination, control mode of spaces during occupied and unoccupied hours.

4. ENERGY CONSUMPTION - Maximum demand and annual usage of all energy sources used at the project site.
 5. MECHANICAL EQUIPMENT - Design capacity, past load data.
 6. BUILDING LOADS - Internal heat generation, lighting, equipment, number of people during occupied and unoccupied periods.
- B. The calculation procedure shall simulate the operations of the building and its services through a full year operating period shall permit the evaluation of the effect of system design, climatic factors, operational characteristics, and mechanical equipment annual energy usage. Manufacturer's data or comparable field test data shall be used when available in the simulation of all systems and equipment. The calculation procedure shall be based upon 8760 hours of operation on the building and its service systems and shall utilize design methods specified in the ASHRAE Handbooks.
- C. The only approved computerized energy analysis software is EnergyPlus.
- D. NO other programs are acceptable.
- E. All input data shall be provided to the Owner at the conclusion of the calculation.
- F. Demonstrate a minimum 24% improvement in the proposed building performance rating for new buildings, or a 20% improvement in the proposed building performance rating for major renovations to existing buildings, compared with the baseline building performance rating. Calculate the baseline building performance rating according to the building performance rating method in Appendix G of ANSI/ASHRAE/IESNA Standard 90.1-2007 (with errata but without addenda) using a computer simulation model for the whole building project.
- G. Steam and Chilled water from the central distribution system shall be used for primary heating and cooling sources in any new or major renovation of a building. Provisions shall be made for heating domestic hot water with other fuels during those months when building heat is not required.
- H. Independent systems using primary energy source are strongly discouraged. Plans for the expansion of the steam and chilled water distribution system into undeveloped areas of the campus have been prepared and should be consulted for new buildings.
- I. Process cooling requirements are those space conditions which require specific temperature and/or humidification to be rigidly maintained. Examples are computer rooms, and clean rooms or other rigid temperature requirements must be maintained 100% of the time. Consider waterside economizers as an alternative scenario for all 24hr by 7day spaces.
- J. The equipment to maintain such spaces shall be independent of the building HVAC system. Each space with its independent conditioning equipment shall have an electronic digital recorder or means to trend through the DDC controls system.

- K. The conditioning equipment selection for computer rooms and other similar spaces shall be based on:
 - 1. 100% of sensible load.
 - 2. Total Cooling (100% sensible + 15% sensible (for dehumidification) x 125 (for future load).
 - 3. Other process cooling or heating equipment must be designed for 1.25% of known loads.

9.01 Facility Requirements:

- A. Facility:
 - 1. Residential, 24-hour operation.
- B. Conditioning Requirements:
 - 1. Air Conditioning: Living area (student bedrooms resident manager living and bedroom), offices, telecommunications rooms and laundry rooms.
 - 2. Mechanical Ventilation: Sanitary facilities, kitchens, vending machine alcoves and rooms, and mechanical rooms containing heat generating equipment.
 - 3. Convection Ventilation: Storage rooms and unassigned spaces.
 - 4. Heating: All spaces having exterior building surfaces.
 - 5. Humidification: Low limit for living areas.
- C. Internal Loads:
 - 1. Living Areas: Assigned occupants, lights off.
 - 2. Laundry Rooms: Lights off, non-ventilated machine loads.
 - 3. Other Areas: 100 sf/person, lights on.
- D. Air Motion Air Conditioned:
 - 1. Classrooms: Provide demand controlled ventilation for all classrooms.
 - 2. Laboratory Areas: Minimum 6.0 air changes/hour.
- E. Outside Air:
 - 1. Classrooms: ASHRAE Standards.62-2001 and latest addenda.
 - 2. Laundry Rooms: None. Obtain makeup air for dryers from circulation areas.
 - 3. Other Areas: Latest ASHRAE Standards.
- F. Temperature Control:
 - 1. Living Areas: Zone, maximum six (6) student bedrooms/zone.
 - 2. Office Area: Zone maximum three (3) offices per thermostat zone.
 - 3. Laboratory Areas: Separate zone per lab.
 - 4. Other Air Conditioned Spaces: Individual room.
 - 5. Service Areas: Low limit.
- G. Humidity provided for maintaining a minimum of 30% relative humidity in all buildings.

- H. Air Filtration: Provide filtration with a minimum efficiency reporting value (MERV) of 13 or higher.
- I. Approved Air Conditioning Systems:
 - 1. No building wide electrical heating systems will be allowed.
 - 2. Low velocity, Variable volume, single zone.
 - 3. Low velocity variable volume, secondary air, terminal reheat.
 - 4. Medium velocity, variable volume primary air, constant/variable volume secondary air; terminal reheat.
 - 5. Air handling units (4 pipe system). Cooling: chilled water; Heating: hot water
 - 6. Fan coil units, self-contained (for use in renovation only).
 - a. Variable refrigerant systems.
 - b. Heat recovery symptoms.
 - c. Radiant heating and cooling.
 - 7. Computer Grade A/C: Air cooled or water cooled w/variable fan speed control condenser. No water cooled systems that reject heat to building chill water loop are acceptable.

10.01 Approved Chill and Hot Water Piping Distributions:

- A. Chill water system: System shall be primary pumping through the building. System shall maintain a 12-15 psi differential pressure set by T & B across the farthest cooling AHU in the system. Provide temperature gauges, pressure gauges, and isolation valves at all building entrance points in a fully serviceable dedicated mechanical space. Pressure and temperature data to be incorporated into the DDC controls network.
- B. Each A.H.U. shall have a 2-way modulating valve and an automatic pressure independent means of controlling maximum flow. Pressure control valves may be considered for this requirement.
- C. All buildings shall have a variable speed chilled water pump sized for the pressure requirements of the building it serves and controlled to maintain building pressure requirements. A pressure reset strategy shall be employed through the DDC controls to vary the pump speed and command the pumps OFF at minimum speeds to protect the motor. A means of bypassing campus water around the pumps shall be provided with controlled isolation and check valves that allow campus pressure to serve the building when the pumps are OFF.
- D. Hot water heating system with natural gas/steam/hot water converter: system shall work from return water temperature to provide peak performance.
- E. The building hydronic circulation systems shall have a standby pump. The pumps shall have a delta pressure switch across the pump provide a feedback into the building automation system which controls the lead/lag and standby pumps selection. See Control Section.

11.01 Balancing of Water And Air Distribution Systems:

- A. All water and air distribution systems shall be balanced by the same contractor to within +10% of the design and design criteria and reported to Architect/Engineer in writing.
- B. All water coils shall have a pressure independent automatic flow control device to ensure max flow or a pressure independent control valve.
- C. Butterfly valves shall not be used as balancing or flow control valves.

12.01 Locating Infrastructure

- A. Place this note on all site drawings: "CONTACT GEORGIA TECH FACILITIES INFRASTRUCTURE AT 404-385-6000 FOR INFORMATION REGARDING LOCATE REQUEST. SUBMIT COMPLETED LOCATE REQUEST FOR GEORGIA TECH OWNED UTILITIES AT LEAST 72 HOURS PRIOR TO ANY EXCAVATION."

13.01 Project Submittal Checklist

- A. Program:
 - 1. Mechanical systems narrative to address:
 - a. Prime energy types state usage
 - b. Off-site mechanical distribution
 - c. Site mechanical distribution
 - d. Piping routes
 - e. Manholes
 - f. Heat conversions systems
 - g. Cooling building plant systems
 - h. Piping methods and materials
 - i. Air handler systems
 - j. Air distribution systems
 - k. Tenant requirements
- B. Preliminary Design:
 - 1. Partial drawings to include the following:
 - a. Off-site utility plans
 - b. Mechanical site plans
 - c. Piping riser diagram
 - d. Equipment placement
 - e. Control strategies and sensor table
 - f. Partial design criteria for basic equipment, materials and methods.
 - g. Submit 4 sets of plans and design criteria to Facilities Design and Construction for review and comment.

- C. 50 - 75% Design Development:
 - 1. Well-developed drawings to include the following:
 - a. Off-site utility plans
 - b. Mechanical site plans
 - c. Mechanical room layouts
 - a. Complete control strategies and sensor table
- D. Design criteria to include the following:
 - 1. Complete set of standard or fully edited design criteria
 - 2. Submit 4 sets of plans and design criteria to Facilities Design and Construction for review and comment.
- E. Final Design Submittal
 - 1. All design criteria, substantially complete.
 - 2. Submit load and expected energy usage calculations as per State of Georgia Energy requirement and Yellow Book requirement.
 - 3. Submit 4 sets of plans and design criteria to Facilities Design and Construction
- F. Construction
 - 1. As-built drawings
 - 2. Drawings and design criteria in electronic form
 - 3. Operating and maintenance manuals.
 - 4. Any pump or piece of mechanical equipment purchased, included in its O&M manual. Blueprints with spec's so any piece can be machined by our machine shops.

END OF SECTION

230003 SPACE CONDITIONS

1.01 Design and Operational Conditions:

- A. Use the design points to design, size, and select all equipment. The construction documents shall indicate that the controls contractor shall set all of his control equipment to maintain the operational set points, not the design points. All occupied spaces shall be enabled with a user adjustment of +/- 3 degrees F.

ROOM TYPE	DESIGN (degrees F)				OPERATION (degrees F)	
	SUMMER		WINTER		SUMMER	WINTER
	DB	RH	DB	RH	DB	DB
Student Bedrooms	75	60	72	30	72.5 ± 2.5	72.5 ± 2.5
Study Rooms	75	60	72	30	72.5±2.5	72.5 ± 2.5
Lounges	75	60	72	-	72.5 ± 2.5	72.5 ± 2.5
Recreation Rooms	75	60	72	-	72.5 ± 2.5	72.5 ± 2.5
Meeting Rooms	75	60	72	-	72.5 ± 2.5	72.5 ± 2.5
Offices	75	60	72	30	72.5 ± 2.5	72.5 ± 2.5
Manager’s Quarters	75	60	72	30	72.5 ± 2.5	72.5 ± 2.5
Manager’s Living Areas	75	60	72	30	72.5 ± 2.5	72.5 ± 2.5
Manager’s Kitchens and Bathrooms	-	-	70	-	-	-
Toilet, Shower and Drying Rooms	-	-	70	-	-	-
Janitor Rooms	-	-	60	-	-	-
Storage Rooms	-	-	60	-	-	-
Laundry Rooms	80	-	70	-	72.5 ± 2.5	72.5 ± 2.5
Main Entrances	80	-	70	-	72.5 ± 2.5	72.5 ± 2.5
Corridors and Passages	-	-	70	-	-	-
Stairwells	-	-	60	-	-	-
Basements	-	-	60	-	-	-
Mechanical Rooms	-	-	60	-	-	-
Classrooms	75	60	72	30	72.5 ± 2.5	72.5 ± 2.5
*Laboratories	75	60	72	30	72.5 ± 2.5	72.5 ± 2.5
Elevator Machine Rooms	75	60	72	-	72.5 ± 2.5	72.5 ± 2.5
Telecommunications Rooms	75	60	72	30	72.5 ± 2.5	72.5 ± 2.5

*Laboratories may require more stringent temperature and humidity requirements. Engineer to evaluate project specific requirements.

END OF SECTION

230004 DESIGN CRITERIA

1.01 General

- A. Chilled water supply temperature from central plant to building: 44 F with winter reset up to 48 F.
- B. Air supply at apparatus: 55 F. Provide temperature reset as required by the energy code.
- C. Steam supply pressure from central plant to building: 50 psig.
- D. Building operation steam pressure: 10 psig.

END OF SECTION

230519 METERING AND RELATED PIPING

1.01 Metering and Piping

- A. Each building shall be equipped with meters for all utilities. Each auxiliary service area in a building shall be sub-metered for all utilities. Mechanical designers should ask Facilities Engineering for a copy of Ga Tech Facilities D&C metering specification 15122-dx200. Use this specification on all projects without any changes.
- B. Natural gas and domestic water, if individually supplied by the serving utility company will be metered by that company. If Ga. Tech Natural Gas system is used the project is to provide metering similar to Atlanta Gas Light Co. standards with a Mercury Instruments correction electronics to include temperature and pressure corrections. The Mercury Instrument shall also have an RS485 com board. The Ga. Tech Natural Gas meter shall be temperature and pressure corrected and provide a contact closure to the metering data logger. Provide full bypass around the meter as well as valved and capped test ports on each side of the meter. Where these utilities are sub-fed to a building, sub-meters shall be provided for metering. Where metering is provided by AGL, provide with RS485 connectivity. In building with multiple gas service connections, submetering may be required for reporting. Consult with EH&S on project basis.
- C. All underground natural gas piping shall be polyethylene piping and valves with an API 598 rating. An AWG 6 yellow insulated stranded signal wire shall be installed coiled around the gas piping for locating. Contact Georgia Tech Facilities Engineering for details. Where natural gas piping is ferrous follow the State of Georgia adapted 200x Standard Gas Code with Georgia amendments and provide cathodic protection.
- D. Any area to be used for uses other than that of the main building (i.e., laundries, food areas, etc.) will be separately sub-metered for all utilities used.
- E. Make up water for cooling towers, and any other water consumed in a process that is not returned to the sewer systems shall be separately metered, using meters that are scaled in cubic feet. The meter shall have a digital signal per 100 gallons and shall be totalized by the metering data logger.
- F. Cooling tower blow down shall be separately metered, using meters that are scaled in cubic feet. The meter shall have a digital signal per 100 gallons and shall be totalized by the metering data logger. These meters shall have a mechanical non-resettable totalizer scaled in gallons or 100 gallons.
- G. Steam consumption will be totalized by a condensate meter which shall be used on all condensate return pump stations. These meters shall have a mechanical non-resettable totalizer scaled in gallons or 100 gallons. These meters shall have a digital signal read by the metering data logger in units of 100 gallons and totalized. Direct steam metering shall be considered for new buildings.
- H. Chilled water meter system shall measure BTU's temperature corrected energy meter. The meter shall have a totalizer non-resettable, provide a visible scale indicating rate of consumption, and shall provide an RS485 Modbus connection to the metering data logger and output proportional to the rate of consumption. Units to be passed to the data logger are, Supply temp, Return Temp, Flow GPM, Btu energy rate BTU/Hr, Totalized consumption BTU-hr, and totalized Ton-hrs.

- I. Owner domestic water meters: The meter shall have a digital signal per 100 gallons and shall be totalized by the metering data logger. These meters shall have a mechanical non- resettable totalizer scaled in gallons or 100 gallons.
 1. Linear flow device shall have a minimum 20 to 1 turndown
 2. Overall accuracy of plus or minus 1% of full scale with repeatability of plus or minus 0.25%.
 3. Flow metering sensor shall be an ultra-sonic Doppler Effect sensor that does not penetrate the piping...
 4. In the case where the flow, temperature and pressure sensors are to be used in a wet location such as in site metering these devices shall have a NEMA 6P rating.
 5. Energy meters that are installed in damp or wet must be one of the following or an approved equal: Yokogawa DX Advanced 2010 Data Logger with submersible transducers.
- J. Metering Data Logger
 1. Shall be a Yokogawa DX Advanced 2010 Data Logger. The data logger shall have 200 megabytes of memory, shall have RS485 Modbus and Ethernet TCP/IP communications ports. Contact GT Facilities D&C for detailed specifications. Installation/Integration contractor is required to notify the Facilities Management IT department via email at askIT@facilities.gatech.edu when installing/configuring Yokogawa data loggers in new or remodeled Georgia Tech campus buildings.
- K. Data Logger mounting rack:
 1. Three (3) compartment, double hinged, 24@high, 20@deep, 19"EIA equipment rack.
 2. Front door to be smoked plexi-glass window.
 3. 400 lb. load capacity
 4. Material: Rear section, center section: 14ga. cold rolled steel.
 5. Cabinet Fan 57 CFM 120v, and fan plate
 6. Reusable dust filter kit for air intakes.
 7. Install door gasket kit on front door and middle door.
 8. Manufacture Hubbell
 9. Provide an Ethernet data connection to the Data Logger.
- L. For new and major renovations, develop and implement a measurement and verification (M&V) plan consistent with Option D; Calibrated Simulation (Savings Estimation Method
 - 2) as specified in the International Performance Measurement & Verification Protocol (IPMVP) Volume III: Concepts and Options for Determining Energy savings in New Construction, April, 2003 or with LEED credits for metering and enhanced commissioning. The M&V period must cover at least 1 year of post-construction occupancy. Provide a process for corrective action if the results of the M&V plan indicate that energy savings are not being achieved. OR Option

2: Develop and implement a measurement and verification (M&V) plan consistent with Option B; Energy Conservation Method as specified in the International Performance Measurement & Verification Protocol (IPMVP) Volume III: Concepts and Options for Determining Energy savings in New Construction, April, 2003. The M&V period must cover at least 1 year of post-construction occupancy. Provide a process for corrective action if the results of the M&V plan indicate that energy savings are not being achieved.

M. Electrical Metering:

1. See section 260100, 2.4, D.7. Each building shall be metered by the supplying utility. If the electrical power is provided by the institution, then the Engineer shall provide a KWH and KW demand meter. See electrical division for additional requirements.
2. Documentation regarding suitability for use in must be submitted for all equipment in accordance with other sections of the technical specification. Inclusion as an accepted manufacturer does not waive the submittal requirement.

END OF SECTION

230900 DDC Controls and HVAC Instrumentation

1.01 Scope

- A. Georgia Institute of Technology (GT) has a standard DDC Control System. The primary purpose of this system is to provide dynamic control, economical operation and operational information of the equipment. When this system is installed it will aid the engineer in certifying that the contractor has installed and setup the equipment to engineer's design criteria. This standard is mandatory before Georgia Tech will accept the mechanical portion of your project. Georgia Tech has an annual State of Georgia contract with its selected DDC controls contractor. Contact the Georgia Tech Facilities Engineering Department for the vendor contacts. It is intended and required in the State DDC contract that the DDC vendor work with the project engineers to develop the most efficient system and to aid the engineers with developing control design criteria to achieve such. The engineer of record shall engage with the Controls Contractor during design and use the controls specifications provided through Georgia Tech Facilities. The contract with the DDC contractor should be directly with the General Contractor.
- B. The consulting engineer in conjunction with the commissioning agent will develop a Measurement and Verification Plan that will identify all sensors that need to be recorded for trend or data extraction. Refer to Section 230519. Contact Facilities Engineering for details.
- C. All renovations of existing facilities.
- D. The DDC contractor shall prepare a pre-bid pricing to furnish and install the controls as described in the plans and design criteria for the Architect. The Architect will place in the " F " Section the following:
 1. The DDC controls as described in this project shall be provided by Johnson Controls, Inc. Contractor under State of Georgia DOAS. This RFP/P.O. has been assigned this contract for building controls work. The General contractor is directed to include Johnson Controls, Inc as the controls contractor. Pricing and change orders, as they relate to the DDC controls, will be priced as per or less than the RFP/P.O. pricing A campus-wide contract has been established with Johnson Controls to provide the facility management system under state of Georgia DOAS contract # 9020017203. This DOAS contract has been consigned to this project. The contact at Johnson controls is Robert Morris (770-294-1355 or robert.b.morris@jci.com) Coordination of division of labor as it pertains to this scope is the responsibility of the General contractor. Division of labor shall be in accordance with 230900.
 2. DDC pricing and scope shall be reviewed and accepted by the engineer of record and GT project manager as a prerequisite to GC accepting a contract from the DDC contractor.

- E. All new buildings built by Georgia Tech, for Georgia Tech or on the behalf of Georgia Tech by the State of Georgia, GSFIC, Georgia Tech Foundation, Georgia Tech Facilities Inc. shall provide building DDC controls as part of the project.
 - 1. Georgia Tech requires all building automation controls (DDC) to be of the type that supports native BACnet protocol and all components shall be approved by the BACnet Testing Laboratory. The DDC vendor shall as part of the project. The Mechanical designer shall use Georgia Tech's specifications "AUTOMATIC TEMPERATURE CONTROL SECTION 230900."

2.01 Details of Controls

- A. Alarms shall be limited to alarm limits that do not create a nuance and unnecessary alarm.
 - 1. Space temperature alarms can be greater than but not less than 3 degs F plus/minus from the EFFECTIVE setpoint.
 - 2. Equipment alarms: example a hot water reheat valve is non operationalnon-operational and the space temperature cannot be maintained. This would cause the command to the hot water valve to be 100% this type of condition should exist for 6 or more hours before alarming. Apply this concept to all alarms. Do not make the mistake of applying a 6 hour delay before issuing and alarm for all the alarms. Apply reasonable judgement on the time delay before posting an alarm.
 - 3. This does not apply where these specifications specify detail any limits or levels. Such as 2.01, D. of these specifications.
- B. Variable air volume units and power mixing boxes: The engineer shall use DDC control modules, with room/space temperature sensor, supply air temperature percent of flow or mix air and reheat.
- C. Fan coils/air handlers units shall have the following:
 - 1. Space sensors, discharge air sensor, return air sensor, mixed air sensor, damper electronic/pneumatic transducer (the actuators may be pneumatic), heating and cooling electronic/pneumatic transducer.
- D. Install a permanent monitoring system to ensure that ventilation systems maintain design minimum requirements. Configure all monitoring equipment to generate an alarm when the air flow values or carbon dioxide (CO₂) levels vary by 10% or more from the design values via either a building automation system alarm to the building operator or a visual or audible alert to the building occupants. Monitor CO₂ concentrations within all densely occupied spaces as defined in the energy code of with an occupancy of over 10. CO₂ monitors must be installed between 3 and 6 feet above the floor. Provide a direct outdoor air flow measurement device capable of measuring the minimum outdoor air intake flow with an accuracy of plus or minus 15% of the design minimum outdoor air rate, as defined by ASHRAE 62.1-2007 (with errata but without addenda) for mechanical ventilation systems where 20% or more of the design supply airflow serves non-densely occupied spaces.

- E. All occupied spaces shall have wireless ZigBee BACnet space temperature sensors, with an occupancy button and a warmer cooler adjustment. Each occupied space shall have a CO2 sensor either wall mounted on return duct mounted. Consult with Ga Tech's Section 230800 (contact Facilities Engineering for the latest copy) for specific control sequences.
- F. Chiller plant optimization controls to interface with the control package provided by the chiller manufacturer. Controls shall have the following points: Chill water supply temperature, chill water return temperature, condenser water supply, condenser water return temperature, indoor air temperature, outdoor air temperature, and chillers start/stop enable chiller set point reset.
- G. Include any temperature and/or pressure sensors that will provide enough information to complete thermodynamic picture of the engineer's project, for example if you are connecting to the central chill water distribution system the engineer should include: temperature sensor, pressure sensors on the supply and return. Also include a flow transducer. Specify BTU calculations on the water extracted from the distribution system. See meter section. Flow metering sensor shall be an ultrasonic Doppler Effect sensor that does not penetrate the piping.
 - 1. The control sequences will be specified by the design project engineer.
- H. The DDC contractor shall program the building controllers and existing DDC central operation server using Johnson Controls Inc, Metasys ADX server to locally log trend data at the building. On a continuous cycle the ADX server shall establish communications with the main building controller and retrieve the trend data. The server based operator workstation shall print the trend data in columns and rows and print a graphic chart depicting graphed data scaled in engineering units over the period of trend capture.
- I. The DDC contractor shall install all graphic displays for all systems and controlled devices in the all ADX server located at the Rich Computing Center. The graphic displays shall illustrate the depiction of the device, sensor and control point locations. The graphic displays shall display dynamic sensor valves in engineering units.
- J. The DDC contractor shall update the Georgia Tech Johnson ADX Metasys server with all set points, analog and digital input points and analog and digital output points.
- K. The central computer shall contain an exact copy of all DDC control sequences in the project.
- L. The DDC contractor shall provide as part of shop drawings a complete block DDC program; showing all logic, set points and control schedules. The contractor shall reference design criteria's sections, and paragraphs to note which portions of the diagram depict the control sequence. The DDC contractor shall install a copy of the DDC control shop drawings on the campus web server.
- M. A complete points list with range and scale for electrical and engineering units shall be provided as part of the shop submittal.
- N. People Counter. This product is an extension of an existing system for GT M&V verification. In order to conform to and be compatible with the existing system this product sole source is required. Manufacturer: Infodev

- O. DDC Internet Communications:
 - 1. Data Transmission Network
 - a. DDC panels and the DDC central station shall be connected through the Georgia Tech Campus fiber optic network, using TCP/IP over an Ethernet, routed network. Provide all equipment, materials and software necessary to connect DDC panel to Owner provided connection to campus fiber optic network. It shall be possible to access any DDC panel through the network. Such access shall include full read write capability from an operational as well as programming standpoint. Total system information shall be available to the operator's station.
- P. Demand Shed and Temperature Setbacks
 - 1. When demand limit programming is required, the system shall be programmed to raise all space temperatures 2°F when commanded by the BAS, with 74°F used as the centerline temperature.
 - 2. Real Time Power Demand Shed program and Set Back modes: Georgia Tech's central Johnson Controls ADX server shall obtain Real Time Pricing by the hour for the next hour and 23 additional hours from Southern Company's electrical Real Time Pricing Server and store them in centrally accessible analog data points. The ADX server shall analyze the Real Time Pricing data.
 - 3. If two consecutive hours are above a predefined set point then the system will send out email messages to inform Ga. Tech' operational staff that the campus will be entering the Real Time Set Back mode (Standby). The ADX will set a tri state value in each building main controller defining which temperature scheduled range to use, normal, standby setback and night setback.
 - 4. If two consecutive hours are below a predefined set point then the system will send out email messages to inform Ga. Tech' operational staff that the campus will be leaving or removing the Real Time Set Back mode (Standby). The ADX will set a tri state value in each building main controller defining which temperature scheduled range to use, normal, standby setback and night setback
 - 5. Each controller shall have 3 temperature mode ranges for control, normal (230002 – HVAC General and Design for setpoints), setpoint with plus-minus 2.5 deg °F, setpoint with Standby plus-minus 5 deg °F, Night setback setpoint with plus-minus 9 deg °F.
 - 6. Override priority of mode ranges shall be:
 - 7. Night Setback overrides, Standby and Normal
 - a. Standby overrides Normal
 - b. Normal being the lowest priority.
 - c. Day-night setback program: provide software to limit the rise or drop of space temperature during unoccupied hours. Whenever the space temperature is above (or below for heating) the operator assigned temperature limit, the system shall be enabled until the temperature is within the assigned temperature limit.

Q. Dashboard

1. The displaying, reporting and control application will have a dashboard interface that will be presented to the user. The dashboard will have selectable widgets available that will display the current energy usage in a building, the carbon usage in the building, the current state of measurement and verification projects (if implemented), and other measurements pertaining to the health of the building. The dashboard widgets will be selectable by the user of the system. If multiple buildings, (determined by project) are included in the reporting and control application, there will be the ability to have widgets for the entire site as well as individual building.

R. Naming Conventions

1. Graphic naming/trend naming/tag naming
 - a. Plant: Holland="H"; 10th Street = "X"
 - b. Chiller/Boiler/Machine/System
 1. Chiller = CH
 2. Boiler = Bx – x=Boiler Number
 - c. Machine/System/Device
 1. Device/measurement
 - a. Graphic = GR
 - b. Trend = TR
 - c. Temperature Sensor = TE
 - d. Supply Temperature Sensor = ST
 - e. Return Temperature Sensor = RT
 - f. Pressure = PR
 - g. Status = ST
 - h. Volts = VT
 - i. Amps = AM
 - j. Level = LE
 - k. Steam lbs/hr = LR
 - l. Anything not defined above, use the first two characters of what it is or what it is measuring/displaying/trending
 1. Propane = Pp
 2. Dearator = De
 3. Loop pumps
 - a. Outside loop pumps – OLP
 - b. Inside loop pumps – ILP
 4. Water Treatment = WT
 5. Well Water = WW

- d. Specific device/graphic/trend number/index number = xxx
 1. In the case of duplication graphics or trends, add to the index number –x where x is a number.
 - a. Example 10th St. Chiller Plant Chiller #7 Supply Water Temperature Sensor: TagID= X-CH7GR015
 - b. Example for 10th St. Chiller Plant Chiller #7 Graphic Graphic Name = X-CH7GR006
 - c. Example for 10th St. Chiller Plant Chiller #7 Trend Supply Temperature Trend Name = X-CH7TRST009
 - d. Example for 10th St. Chiller Plant Chiller #7 duplicate trend of the supply temperature Trend Name = X-CH7TRST009-2

3.01 Equipment

A. Control Dampers

1. Minimum outside air dampers will be two-position parallel blade type; maximum outside air, return air and exhaust air will be modulating opposed blade type.
2. Return air dampers will be normally open; all others normally closed.
3. Modulating dampers over ten (10) sq. ft. face area will have positive positioning operators. All dampers will move to their normal positions on shutdown of the supply air fan.
4. Damper construction will be heavy duty commercial quality with steel damper blades, steel shafts, oil tight bearings and rigid structural steel frame.
5. All dampers will have corrosion resistant finish; those exposed to the outside air will have galvanized blades and frames, and cadmium plated shafts.
6. All dampers will have blade edges and ends stripped with a resilient material or will have some other effective sealing method to limit leakage to 20 cfm/sq. ft. when closing against 4" w.g. static pressure.
7. Frames for dampers installed within lined ductwork will have flange dimension equal or greater than specified lining thicknesses. Spacers equal to lining thickness may be used to support damper frames installed within lined ductwork.
8. Damper operators will be selected for not more than 80% of published ratings. Linkage arms will be attached to shafts with two set screws 90 degrees apart.

B. Carbon Monoxide Monitor:

1. As an added safety factor a carbon monoxide monitor shall be provided in the mechanical room where a fuel or gas fired boiler is utilized. Refer to Section 283100 – Fire Detection and Alarm for requirements.

C. Pressure sensors

1. Pressure sensors must have a 1% basic accuracy over the 0 - 150 psi range. Sensors must maintain a 2% accuracy when being read remotely through the building automation system network.
2. When installed underground, vent or equalization tubes must be installed in a manner to prevent the entrance of water when the vault is in a flooded condition. Provide a sensor lead loop filled with glycerin from sensor element to pipe connection to prevent rupture from water freezing in lead tube. Pressure sensors must provide a 4-20mA output signal for connection to the building automation system.
3. Documentation regarding suitability for use in submersible application must be submitted for all equipment in accordance with other sections of this specification. Inclusion as an accepted manufacturer does not waive the submittal requirement.
4. Space thermostats shall be The WRZ-TT Series Wireless Room Temperature Sensors shall sense and transmit room temperatures, room set point, room occupancy notification low battery condition to an associated ZFR1811 Router.
5. Lead/Lag Pump Controller: Additional relay logic can be added should your design require it.

D. Carbon Dioxide Sensor:

1. Add CO2 monitors in each temperature zone next to the DDC space sensor.
2. Approved Monitor: Johnson Controls CD-W00-00-1 or submit for equal

4.01 Sequence of Operation

A. The sequence of operation is a requirement of any new or redesigned air handling unit. The following list of sequences shall be included in, but shall not limit, the sequences of operation:

1. The minimum outside air damper will open when the supply air fan starts. Night set back shall be specified, the minimum outside air damper and interlocked exhaust fans will remain de-energized during the warm-up period. Use a ± 9 degf offset for night setback.
2. The thermostat sensor for modulating control of the dampers will have an averaging type element located in the cold deck plenum or air supply ductwork.
3. Thermometers and/or temperature calibrated branch pressure gauges will be provided for indicating supply air, return air and outside air temperatures.
4. Prior to adjustment of minimum outside air quantity, complete the adjustment of supply air quantity and shutoff cooling.
5. Use the following formula to calculate percentage outside air (% OSA):

$$\% \text{ OSA} = (T_s - T_r) / ((T_o - T_r) / T_r)$$

T_s = Supply air or cold deck temperature T_r = Return air temperature

T_o = Outside air temperature

6. Take temperature readings and make damper adjustments until calculated percentage of outside air is within plus or minus 10% of the quantity specified. Mark linkages at final adjustment position.
7. Specify that records of readings, calculations, and adjustments will be lodged with architect. The starting sequence shall be listed, including the timing and starting order of all motors and the order they start.
8. All operating conditions including controlling inside, outside, and air handler temperatures and humidistat's.
9. Damper operational conditions including minimum conditions shall be listed, and modulation of zone dampers, in multi-zone units, shall be listed.
10. Hot and cold deck resetting conditions shall be listed.
11. Hot and chilled water valve resetting conditions shall be listed.
12. Conditions for modulation of variable air volume systems shall be listed.
13. Night setback (up) and morning start-up conditions and sequences shall be listed.
14. Any interlocked equipment shall be listed.
15. Describe enthalpy economizer cycle.
16. Return air fans will be electrically interlocked with their respective supply air fans.
17. Seasonal changeovers of heating and cooling shall take into consideration the chilled water temperature. The seasonal changeover shall be set at outside air temperature of 65 degrees. If the chilled water temperature is not less than 55 degrees maintain 100 percent fresh air, otherwise operate outside air dampers under normal control sequence.
18. Demand Control Ventilation with VAV Terminal Unit
 - a. Change the minimum air of the VAVs to $\frac{1}{4}$ of their existing settings.
 - b. AHU during unoccupied periods: When all the temperature zones are in the unoccupied state, turn the fan off and command the VAV boxes to close (zero min cfm). Every hour in the unoccupied mode, run the fan 10 minutes and all of the VAV units are to go to the minimum cfm for this time period. At the ends of this cycle, all VAV's go to close and Fan is off. Stage the AHU's: do not run more than one AHU at a time during this unoccupied cycle.
 - c. During Occupied periods: Control the space temperature as programmed today. The CO₂ set point will be 1000 ppm. If the CO₂ gets above set point, then start increasing the minimum air flow until CO₂ is below set point. Maintain temperature with reheat. Rate of change should be no more than 10% per minute.
 - d. In the case of occupancy override: Start the AHU and allow the VAV that has the override signal to operate, but keep all the other VAVs closed.

19. Carbon Monoxide Sensing in Boiler Rooms

- a. The monitor shall have two levels of alarms. The low level alarm shall be set to 40 ppm. When activated after a 2 second delay a signal shall be sent to all gas fired equipment shutting them down. Also a signal shall be given to the digital dialer (of the fire alarm system), the dialer shall transmit a code to the Georgia Tech Police Station indicating the heating equipment has been shut down. This does not set off the fire alarm.
- b. The high level shall be set to 50 ppm. When activated after a 2 second delay it shall trip a fire alarm zone. The fire alarm shall activate the dialer. The dialer shall transmit a code to the Georgia Tech Police Station indicating a CO delay of 2 seconds shall ensure against false alarms.

END OF SECTION

230901 COMPRESSED AIR PIPING SYSTEMS

1.01 Pneumatic Control Systems Are Becoming Limited and Will Only Be Used For Selected Buildings.

- A. Buildings control air will be provided with 100 psig clean dry air from air compressors.
 - 1. Air compressors will be sized for one-third operating time.
- B. All compressed air will use duplex compressor units.
- C. Air will be dried by refrigerated units.
- D. Tubing in mechanical rooms, other exposed locations and inaccessible locations will be seamless copper; concealed tubing in accessible locations will be polyethylene. Tubing will be attached to equipment and building by use of brackets and fasteners in a neat orderly manner.
- E. Remote sensor type controllers shall have adjustable throttling range and authority and will be used in mechanical rooms with controllers installed in cabinets. Branch pressure gauges will be installed on all controllers. All controllers will be provided with nameplates.
- F. On loss of operative power, controls shall sequence apparatus so as to prevent freeze damage to mechanical systems.
- G. All renovations and new projects shall de-grease and purge the compressed air piping before connecting to controls.

END OF SECTION

231112 CAMPUS CHILLED WATER DISTRIBUTION SYSTEM

1.00 Campus Chilled Water Distribution System

- A. Estimated system load will be determined by survey of listing permanent buildings, and assessment of planned future buildings and land area reserved for future building sites.
- B. The block cooling load of each existing permanent building will be calculated using design conditions and calculation procedures established by these criteria. The rated or design capacity of existing refrigeration machines shall not be used to assess building loads.
- C. If preliminary plan or programs are available for planned future buildings, estimated cooling loads shall be based on three (3) hundred square feet of gross building floor area per ton. If plans or programs are not available, cooling loads shall be estimated to be one (1) ton per thousand square feet for land area.
- D. Estimated cooling loads for undeveloped areas reserved for future building sites will be based on two (2) ton per thousand square feet of land area.
- E. Campus chilled water distribution systems will be designed in accordance with master plans developed by the institutions and approved by the Board of Regents.
- F. First considerations in developing system master plans are:
 - 1. Campuses will be sub-divided into zones, each zone forming an independent system.
 - 2. Each zone should have an existing or potential cooling load of 1000 tons of refrigeration or more.
 - 3. Each zone will encompass ground area of approximately the same elevation.
 - 4. Zone will be compact area of minimum perimeter avoiding extension across main vehicular roadways whenever possible.
 - 5. Zone boundaries for undeveloped campus areas will be established based on approved master campus development plans.
- G. Considerations in establishing pipe routing are:
 - 1. Lines will be routed to obtain maximum utilization of mains, i.e., maximum loading per unit length.
 - 2. Piping runs will be straight, parallel to building rows or other established campus pattern, with turns made at 90 degree angles whenever possible.
 - 3. Piping shall not be installed under roads, except to cross.
 - 4. System piping may be routed through existing basements and under future building locations. System piping under buildings will be installed in walk-through tunnels.
 - 5. Piping may be installed under and parallel to walkways.
 - 6. Existing permanent buildings will be surveyed to establish entry points and routing of branch lines.

2.01 Underground Chilled Water Pipe Specification

- A. Specify a complete HDPE jacketed system of factory pre-insulated steel piping for the chilled water service. The jacket throughout the entire system shall incorporate electric fusion, butt fusion, or extrusion welding at all fittings, joint closures, or other points of connection. This shall create a jacket that is seamless throughout the entire system with the exception of anchors, whose water shed rings are sealed with a Raychem Dirax or Canusa GTS-65 wrap prohibiting the ingress of water. The system shall incorporate a copper wire, as specified below to make the system leak detection ready. All pre-insulated pipe, fittings, insulating materials, and technical support shall be provided by the Pre-insulated Piping System manufacturer.
- B. Underground:
 - 1. Steel Pipe and Fittings: Steel pipe and fittings shall be furnished in accordance with American Water Works Standard C-202-64T. Steel pipe shall be furnished with exterior 1" foam insulation and HDPE covering.

Pipe Size and Wall Thickness	
Pipe Size	Wall Thickness
4" ID	15/64"
6" ID	9/32 "
8" ID	1/4"
10"ID	1/4"
14"ID	1/4"
20"ID	1/4"

- 2. Fittings: Fittings shall be fabricated the same thickness and I.D. as the pipe. Maximum angular change shall not exceed 22 - 2 degrees per cut. Fittings 0 to 60 degrees shall conform to short radius dimensions. Fittings 60 to 90 degrees will be long radius dimensions. Fitting wall thickness shall be the same as the associated pipe reinforced as necessary.
- 3. Under Ground Chilled Water Insulation: The insulation and jacket cover shall be factory applied. The exterior coating shall be HDPE
 - a. Material: Insulation is to be not less than one inch (1") wall thickness rigid polyurethane foam. Density of polyurethane to be not less than 2.5-3.5 pounds per cubic foot, with a thermal conductivity (k) not less than of 0.14 BTU/hr-sq. ft.- degree F/in.
- C. Butterfly Valves (Underground): All underground butterfly valves shall be high performance dual offset type complete with valve operators for buried services, extension stem, operating nuts. All underground valves shall be placed in a valve manhole/valve box that is large enough for a man to service the valves. The manhole shall have drain. The valves shall be insulated with removable boots. Service requirements shall be 150 psig operating pressure and line velocity of 12 feet per second. **DO NOT DIRECT BURRY ANY VALVES.**

- D. All chill water service lines from the campus distribution piping to any project and/or building shall have a chill water manhole with butterfly valves.
- E. Manholes/Valve Boxes, All manholes manhole/Valve Box & covers shall provide for minimum of AASHTO H-20 loading. Provide a gravity drain or pumped drain. If gravity drain is connected the sewer provide a backflow valve to prevent backup into the manhole/valve box. The manhole shall provide for a clear opening of 36 inches. The cover for manholes shall be a 2 part cover with one part being a 38 inch cover with a 22 inch diameter. Removable lid having a 6 inch offset from the center of the main lid. The 22 inch removable lid shall have casted in the cover “G* -# #Chill Water” where * equals the GT UMAP grid number and where # equals the next consecutive chill water manhole number in the GT UMAP grid that the work is being performed. Valve box 5” covers for adjustable valve boxes, have “CHILL WATER” stamped and stamped and/or casted in the cap/cover. Request GT Design & Construction to provide these numbers.
- F. Field Service: Specify field service provided by a factory representative. The factory representative will be available at the job to test all HDPE fusion welds, check pipe installation, conduct system pressure testing, inspect field joint insulation, and observe backfilling techniques.
- G. Obtain a material specification for underground piping directly from the Facilities Engineering offices.

END OF SECTION

231113 HYDRONIC PIPING

1.01 Building Hvac Piping System Reference Standards

- A. ANSI/ASME 816.3: Malleable-iron threaded fittings.
- B. ANSI/ASTM A53A: Pipe, steel, black welded and seamless for ordinary purposes.
- C. ANSI/ASTM A126: Gray iron castings for valves, flanges, and pipe fittings.
- D. ASTM C645: Steel framing
- E. ASTM A525, G-60: Hot dipped galvanized.
- F. ANSI/ASTMB88: Copper piping.
 - 1. Pipe: Type “L” hard copper tubing conforming to ANSI H.23.1, 1972.
 - 2. Pipe: Schedule 40 black steel conforming to ANSI B36.20, 1977.
 - a. Steel piping shall be welded joints for equal to or greater than 2 ½” piping. Screwed joints may be used for joints less than 2 ½”. Grooved piping joints are not allowed for any hot and/or chilled water piping.
 - 3. Automatic Air Vents: Automatic air vents shall be an assembly comprised of both an automatic air vent and a manual air vent assembly. Provide an air vent at each high point of the circulating piping systems. Discharge shall be piped to nearest floor drain or unit drain pan. Discharge lines shall be run close to structure, walls, or larger piping.
- G. Copper to Steel Adapters: Provide cast bronze adapters at all copper connections to steel pipe. Adapters 2" smaller shall be cast bronze. Adapters larger than 2" shall be 150 lb. ANSI B16.25, 1977, cast bronze flanges.
- H. Cooling Coil Condensate Piping:
 - 1. Pipe: PVC or copper type L.
 - 2. Material: ASTM B1785 with solvent cement joints.

2.01 Valves, Strainer, Unions And Flanges

- A. Valves, strainers and flanges shall be rated at not less than 125 psi steam and 200 psi WOG working pressure.
- B. Valves 1 1/2" and smaller shall be ball valves and shall have screwed bronze body and bronze trim.
- C. Valves 2" and larger shall have flanged iron body and bronze.
- D. Butterfly valves used for main building shut off service shall be high performance dual offset type.
- E. Butterfly valves shall have iron body, bronze alloy disc, stainless steel stem, replaceable EDPM seats and O rings with 100% shutoff. Valves shall have infinite setting type lever handle with memory setting feature. Valves shall be water type. Valves shall be Crane, Damco, Norris, Jenkins Lukenheimer.
- F. Strainers shall be Y-pattern type rated at not less than 125 psi steam and 200 WOG working pressure.
- G. Strainers 1 2" and smaller shall have screwed iron body.
- H. Strainers 2" and larger shall have flanged iron body.

- I. Strainers baskets shall conform to the following:

<u>Service</u>	<u>Material</u>	<u>Perforation</u>	<u>Open Area</u>
Chilled Water	Brass	1/10"	35% - 40%

- J. Strainers shall be full size of the connection pipe.
- K. Unions shall be provided in each pipe connection to all equipment.
- L. Pipe 1 1/2" and smaller shall have malleable iron 150 psi screwed unions with ground joints. Pipe 2" and larger shall have 150 psi flanged unions.
- M. Route piping parallel to building lines.
- N. Provide sufficient union, flanges and shut-off valves to permit removal of equipment.
- O. Spacing: Adequate to permit servicing valves and specialties and replacing sections of pipe.
- P. Slope pipe to permit complete draining. Install drain valves at low points.
- Q. Arrange hangers for adjustment of load and elevations after installation.

3.01 Penetrations Of Walls And Floors:

- A. At wall penetration: Pack the opening around pipe with non-shrink materials. At exterior face patch with an acceptable elastomeric sealant and paint to match existing wall color where penetration is exposed and visible.
- B. All penetrations through walls, floors shall be core drilled.

4.01 Field Verification Of Chilled Water System

- A. The design engineer shall be solely responsible to field verify which pipe is supply and return of the chilled water system, after it is piped into the building and before any additional piping is connected to building loop. The building piping shall have entrance valves just inside the building. Hose bibbs shall be installed between valves and flange plates. The engineer shall determine which pipe is supply and return by bleeding chilled water outside with hoses until steady state temperature is reached in each line and record the temperatures. Also the engineer shall record the supply and return temperatures of the chilled water system at nearest buildings on the chilled water system as a comparison.
- B. The supply and return line valves shall be tagged with the words A supply@, A return@ and signed by the engineer. A letter of certification shall be submitted to the Owner.

5.01 Interior Chill Water Systems

- A. All interior chill water systems insulation shall be closed cell insulation with a protective cover/coating. Fiberglass is not an approved insulation. Closed cell material is to be rigid insulation with a thermal conductivity (k) of 0.16-0.18 btu/hr-sq. Ft. -degree f/in.

6.01 AHU

- A. Before and after all ahu heating and cooling, coils, heat exchanger, chillers place a temperature gauge, pressure gauge, pete's plug, dry well, and DDC temperature sensor.
- B. When new piping is installed in a building with finished spaces, the piping shall be leak tested first with air at no greater than 40psig. Once passing the air test, a subsequent hydrostatic test shall be used to further validate the system. Hydrostatic testing shall be at 1 ½ times working pressure for at least four hours.

END OF SECTION

232123 HYDRONIC PUMPS

1.01 Pump Characteristics

- A. Chilled water pumps used on building systems shall be long coupled, horizontal direct drive, double suction centrifugal type. The pump shall be mounted on either a cast iron or steel base and driven by an electric motor.
- B. The pump shall be constructed of the following materials:
 - 1. Case wearing rings: Bronze ASTM B144-3B
 - 2. Casing: Cast iron ASTM A48-56
 - 3. Ball bearings: Steel
 - 4. Seal: Mechanical (carbon/ceramic)
 - 5. Shaft sleeve: Stainless steel
 - 6. Impeller: Bronze ASTM B144-3B
 - 7. Shaft: Carbon steel
 - 8. Coupling guard: Formed sheet steel
- C. Constant or Variable speed pumps shall not exceed 1750 rpm.
- D. Pump case and components shall be so designed and manufactured as to withstand hydrostatic pressure equal to a minimum of two (2) times the greatest pressure imposed on the system.
- E. Where a specific project has more than one (1) chilled water pump, all chilled water pumps will be of the same manufacturer.
- F. All pump sets shall have the provision to measure the pressure drop across the pump and the temperature of the water. Pumps shall have a flange pressure port on entry and exit.
- G. An auto/manual air vent shall be provided on all pump sets to eliminate trapped air in the pump.
- H. Provide stand by pump for chill water system.
- I. Butterfly valves shall not be used for balancing valves. Provide circuit setters for balancing pumps. Variable speed drives may also be used for balancing pumps.
- J. Provide isolation valves on both sides of the pump. Circuit setter valves shall not be used as isolation valves.
- K. For pumps larger than 20hp, no mechanical seals on condenser water pumps. Packing only.

END OF SECTION

232213 STEAM & CONDENSATE HEATING PIPING

1.01 Piping Characteristics

- A. Estimated system load will be determined by survey of existing permanent buildings, and assessment of planned future buildings and land area reserved for future building sites.
- B. The block heating load of each existing permanent building will be calculated using design conditions and calculation procedures established by these criteria. The rated or design capacity of existing heating systems shall not be used to assess building loads.
- C. Preliminary plans and programs are available for planned future buildings: Estimated heating loads shall be based on 55 MBH per thousand square feet of gross building floor area. For areas that plans or programs are not available, heating loads shall be estimated to be 30 MBH per thousand square feet of land area.
- D. Estimated heating load for undeveloped areas reserved for future building sites will be based on 30 MBH per thousand square feet of land.
- E. The steam distribution system will be designed in accordance with the master plan developed by in the institution and approved by the Board of Regents.
- F. First considerations in developing or extending system master plans are:
 - 1. Campus will be sub-divided into zones. Zones are to be separated by valves for zone isolation.
 - 2. Zones will be compact areas of minimum perimeter, avoiding extension across main vehicular roadways whenever possible.
 - 3. Zone boundaries for undeveloped campus area will be established based on approved master campus development plans.

2.01 Considerations for Establishing Pipe Routing Are:

- A. Line will be routed to obtain maximum utilization of mains, i.e., maximum loading per unit length.
- B. Piping runs will be straight, parallel to building rows or other established campus pattern, with turns made at 90 degrees wherever possible.
- C. Piping shall not be installed under roads, except to cross.
- D. System piping may be routed through existing basements and under future building locations. The piping under buildings will be installed in walk-through tunnels. Underground distribution systems shall be installed in pipe tunnels with removable covers. Where tunnels cannot be used, conduit systems shall be used.
- E. Piping may be installed under and parallel to walkways.
- F. Existing permanent buildings will be surveyed to establish entry points and routing of branch lines. Steam line entry into building shall be as near as possible to the mechanical rooms.
- G. Primary supply lines shall not be routed through or over occupied areas.
- H. Floor pits shall be provided at entries to buildings without basements.

- I. Steam piping for the distribution systems shall be ASTM A-53, grade B, schedule 40 seamless steel with welded joints. Condensate piping for the distribution systems shall be schedule 80 seamless steel with welded joints.
- J. Under Ground steam and condensate Insulation: The insulation and jacket cover shall be factory applied. The exterior coating shall be HDPE; a material specification for underground piping should be obtained directly from the Facilities Engineering offices. It is recommended that the design engineer contact Ga. Tech Facilities D&C Engineering and obtain a copy of Facilities Engineering specifications Section 23225 Underground Preinsulated Steam Piping Systems and Section 232223 Pressure-Powered Sump Pumps to use in the bid documents.
 - 1. Material:
 - a. HDPE jacketed system of factory preinsulated steel piping for the specified service. The jacket throughout the entire system shall incorporate electric fusion, butt fusion, or extrusion welding at all fittings, joint closures, or other points of connection. This shall create a jacket that is seamless throughout the entire system with the exception of anchors. All preinsulated pipe, fittings, insulating materials, and technical support shall be provided by the preinsulated piping system manufacturer.
 - b. The steam supply line, and the medium pressure condensate line shall be furnished in separate jackets. Each line shall be equipped with completed leak detection system. Provide a portable testing unit.
 - c. Insulation shall be polyisocyanurate foam insulation bonded to both the jacketing and carrier pipe and either spray applied or high pressure injected with one shot into the annular space between carrier pipe and jacket with a minimum thickness of 2-1/2" for systems operating at or below 366°F. Insulation shall be rigid, 85% closed cell foam insulation with not less than 2.4 pounds per cubic foot density, having a compressive strength of not less than 30 psi @ 75°F and a coefficient of thermal conductivity (K-Factor) not higher than 0.17 @ 75°F and 0.30 @ 366°F. Maximum operating temperature of the system shall not exceed 366°. Insulation thickness shall be standard manufacturer's recommended thickness for the size of the steam pipe.
 - d. Leak Detection in Piping. The piping system manufacturer shall install a wire in a manner that has the wire embedded in the foam insulation and not touching the piping.
- K. Leak Detection in Piping. The piping system manufacturer shall install wire in a manner that has the wire embedded in the foam insulation and not touching the piping.
- L. Valve bodies may be either cast or wrought steel; trim shall be stainless steel. Flanged joints shall be used for valves, strainers and other accessories for easy removal for cleaning and replacement.

- M. Valve Insulation Covers: Provide reusable insulation covers for all valves 4-inches and above. The covers shall be used to butt against the field-applied insulation. A skirt with a drawstring will be provided at each end of the cover to provide approximately 4 inch of overlap with the insulated mating pipe. The insulation thickness of the mating pipe will be specified in the project specification. The outer and inner jackets shall be constructed of Silicon Impregnated Nomex Cloth (11 oz./yd²), with an Inconel knitted wire mesh covering on the inner jacket. The insulation shall be Pyrogel or Aerogel... All stitching on the inner jacket. All stitching shall use Teflon coated Nomex thread and the fasteners shall be 20 gauge T-304 stainless steel wire twists with mating lacing pins. The valve covers shall be manufactured by the valve company to ensure proper fit and provide for single source responsibility or approved equal. If valve manufacturer does not provide insulated valve covers, then contractor shall provide insulated valve cover of proper fit with each type of valve used on the project.
- N. All distribution valves in the steam line shall be high performance ZERO leakage valves with metal to metal seating and triple offset conical seating.
- O. Underground piping covering 150 mils, HDPE cover shall be used for steam and condensate lines. Joints shall be electro fusion welded and tested to 5 psi.
- P. Provisions for expansion may be through U bends, offsets,. Expansion joints shall be designed and installed anchors and guides to properly control movement and stresses in elbows.
- Q. All steam distribution lines drip leg and manhole traps shall be carried to the nearest building to the condensate receiver. **DO NOT CONNECT TRAPS TO THE PUMPED CONDENSATE LINES.** Drip legs and manhole traps shall consist of two parallel trap assemblies with isolation valves for each trap.
- R. All building condensate systems shall have a pumped condensate receiver and pumped into the campus **PUMPED CONDENSATE LINES.**
- S. System distribution pressure shall be 55 psig.
- T. Building operation pressure shall be 10 psig.
- U. Steam consumption will be totalized by a condensate meter which shall be used on all condensate return pump stations. These meters shall have a mechanical non-resettable totalizer scaled in gallons or 100 gallons. These meters shall have a digital signal ready by the DDC Control system and totalizer. The DDC system shall be programmed to sum and store the gallons passed through the meter. The digital signal shall be connected to the specified metering data logger.
- V. All piping designs shall have a finite element stress analysis performed by the basis of design piping manufacture **BEFORE** the design is put out to bid. This process will identify any extreme stress locations in the piping design.

- W. The system shall be specified to be Leak Detection Ready by means of installing a bare copper wire between the carrier pipe and the HDPE jacket. Require the piping system manufacturer to install the wire in a manner that has the wire embedded in the foam insulation and incorporated into each piece of pre-insulated pipe and fittings. Specify that the Contractor shall check continuity and electrical isolation of each piece of insulated pipe and fittings with a standard ohmmeter as it arrives at the jobsite. Specify that the Contractor shall connect the copper wires together at each field joint with the supplied insulated jumper cable and recommended crimping tool as per manufacturer's instructions. Specify that the Contractor shall then check for continuity and electrical isolation using a standard ohmmeter over the length of the installed piping system before insulating straight run joint kits. After the piping system is installed, the Owner at any time may check the system for a leak by using a standard volt ohmmeter. Specify that in the event a leak is detected, the system manufacturer will be responsible to provide for a Time Domain Reflectometer (TDR) to determine the location of the leak for a warranty period of one year after installation. Specify that an alarm panel be installed, which will provide continuous leak detection monitoring.
- X. Field Service: Specify field service provided by a factory representative. The factory representative will be available at the job to test all HDPE fusion welds, check pipe installation, conduct system pressure testing, inspect field joint insulation, and observe backfilling techniques
- Y. Obtain a material specification for underground piping directly from the Facilities Engineering offices.
- Z. Mandatory items:
1. Spence PRV are the only acceptable steam PRVs.
 2. High Performance Butterfly (HPBF) Valves (Steam and Steam Condensate 2-1/2 Inches and Larger)
 - a. High performance butterfly valves (HPBF) 2½ inches and larger in size shall be ANSI 150 pound class, cast carbon steel body, 316 stainless steel disc, 17-4 stainless steel shaft, single flanged lugged body style suitable for dead end service. Valves shall be of triple offset design to allow the disc to swing free of the seat in the open position. Seat design and material shall be single piece polymer RTFE with no o-rings or springs. Valves shall seal bi-directionally at full ANSI rating and shall be positive shutoff type. Valves shall have internal stop to prevent disc over-travel.
 - b. HPBF valves shall conform to ASME B 16.5, ASME B 16.34, MSS-SP-6, MSS-SP-68, API-609 for butterfly valves. Valve packing and trim shall be suitable for steam and steam condensate service. Valve packing shall be non-asbestos type.
 - c. Valves 4 inches and larger shall have manual gear operators. Valves 3 inches and smaller shall have handle actuation. Operator extension shall be provided to accommodate adjacent pipe insulation.
 - d. HPBF valves (steam service valves 6 inches and larger) shall be installed with a 1-inch globe valve bypass around the valve.
 - e. HPBF valves shall be Cameron WKM DynaCentric or Owner approved equal.

- f. Each HPBF valve shall be provided with a flange pipe spool section of length to match a standard ANSI 150 pound class gate valve.

3.01 Steam Manhole:

- A. Shall be H20 rated structures. All steam line valves and valve assemblies shall be placed in steam manholes. Each steam manhole shall include a steam powered sump pump. The basis of design Basis of Design: Emerson Penberthy c/o Control Southern, Inc,3850 Lakefield Drive, Suwanee, GA 30024. Description: Model 2R-SL Factory-fabricated, non-electric, pressure-powered sump drainer. Suitable for sump pump service. Horizontal liquid discharge. Stainless steel low resistance check valve for water inlet and discharge and strainer screen on bottom inlet of pump. No electrical energy shall be required.
 1. A sump for the pump shall be provided in the manhole. The steam, vent and eject lines shall have union couplings such that the pump can be removed for service. The ejection line shall be 2" copper tubing.
- B. Steam manhole covers shall provide for minimum of AASHTO H-20 loading. The manhole shall provide for a clear opening of 36 inches. The cover shall be a 2 - part cover with one part being a 38 inch cover with a 22 inch diameter. Removable lid having a 6 inch offset from the center of the main lid. The 22 inch removable lid shall have casted in the cover "G*-*#STEAM" where * equals the GT UMAP grid number and where # equals the next consecutive manhole number in the GT UMAP grid that the work is being performed. Request GIT Design & Construction to provide these numbers.
- C. Basis of Design NEENAH FOUNDRY R-1741-D* Type C lid or 1581 East Jordan Iron Works.
- D. Install two (2) 8 inch iron pipes for natural ventilation. Install one approximately 1 foot from the manhole ceiling and another approximately 1 foot from the floor of the manhole. Install with a slope of 1/8 inch to the foot rise and extend the pipes above finish grade (if in the grass) 4-6 inches above finish grade. If finish grade is in a walkway, then the top of the grate to be flush with the walkway grade. The surface end of the ventilation pipe shall be covered with a cover that has at least 50 percent free opening. Drain grates are acceptable. Georgia Tech has install steam manhole ventilation tops to look similar to short area lighting post. See Klaus COC courtyard as an example.

END OF SECTION

234100 AIR TREATMENT EQUIPMENT-FILTERS

1.01 Filter Characteristics

- A. Air filters will be installed in all air handling system for the following purposes:
 - 1. To prevent fouling of heat exchange surfaces and mechanical equipment installed in the air stream.
 - 2. To remove contaminants from conditioned air supplied of critical areas.
 - 3. To remove pathogenic material, paint and grease from exhaust air.
 - 4. To remove lead dust from re-circulating air systems in firing ranges.
- B. All air filters, except those installed in kitchen range hoods, will be renewable media type see ASHRAE Systems Handbook 2004 Chapter 24. Range hood filters will be permanent type.
 - 1. 2' x 2' filters will be specified for all apparatus.
- C. Permanently installed filter gauges will be provided for all systems.
- D. Permanently installed filter gauges will be provided on all exhaust systems having filters.

END OF SECTION

236416 CENTRIFUGAL AND ROTARY SCREW WATER CHILLERS

1.01 Refrigerants

- A. Centrifugal or screw water chilling machines shall be used on projects. All chillers shall be based on or HFC refrigerants R-134a, R-407c, and R-410A hydro fluorocarbon.
- B. This shall apply to ALL small and large refrigeration equipment.
 - 1. There will be zero use of chlorofluorocarbon (CFC) – based refrigerants in new base building HVAC systems. When reusing existing HVAC equipment, complete a comprehensive CFC phase-out conversion prior to project completion. Phase-out plans beyond the project completion date will be considered on their merits.
 - 2. Select refrigerants and HVAC &R that minimize or eliminate the emission of compounds that contribute to ozone depletion and global climate change. The base building HVAC&R equipment must comply with the following formula, which sets a maximum threshold for the combined contributions to ozone depletion and global warming potential: $LCGWP + LCODP * 10^5 \leq 100$

2.01 Other Characteristics:

- A. Electric motor driven machines will be constant or variable speed type with motor shaft speed **not exceeding 3600 rpm.**
- B. Compressors may be single or multiple stage. Evaporators may be flooded or direct expansion type.
- C. Machines shall be specified to deliver water at a temperature of 40 degrees F with evaporator temperature not below 32 degrees F assuming a condenser fouling factor of 0.0001 and the evaporator fouling factor of 0.0005 with an entering water temperature of 52degrees F, shall have a 12 degree delta temperature drop. Condenser shall be configured for EWT 87 degree F, LWT 96.5 degree F.
- D. A factory performance test shall be run and a certified test report is required to verify the design operating conditions.
- E. Machine control systems shall be electric. Safety controls shall include a flow switch or differential pressure switch low temperature cut-off thermostat in the chilled water circuit.
- F. Provide discharge and liquid line refrigerant isolation valves to allow isolation of the entire charge in the condenser while servicing the compressor. Check valves shall not be accepted.
- G. Chiller control interfaces:
 - 1. The interface shall be a high speed BACnet RS485, RS-232 serial or Ethernet interface. The chiller on board controls shall all total remote operations to start, stop, change all set points, obtain all chiller on board monitored sensors and read all alarms.
 - 2. All chillers to be installed in the Holland Chiller Plant or the 10th St Chiller Plant shall interface with the existing Bailey Network 90 chiller plant control system.
 - 3. All other chillers shall have a DDC interface.

- H. Machines shall be installed in ground level or basement mechanical rooms with sufficient clearance provided perform all necessary routine maintenance, repairs and replacement of components.
- I. Where a project has more than one (1) chiller, all chillers will be of the same manufacturer.
- J. Equipment performance shall be in accordance with of the Georgia State Energy Code ASHRAE 90.1-2001. The chiller shall have a kilowatt per ton rating within the range of 0.56-0.62 kw/ton. The designer should request NPLV ratings for the selected chiller, with the BIN weather data for Atlanta, Georgia.
- K. The condenser and chilled water systems shall have a standby pump. A delta pressure switch across each pump shall provide a feedback signal to the building automation system which controls the lead/lag and standby pumps selection. See Controls Section.
- L. All chillers shall have a 4 year extended warranty.

END OF SECTION

236500 COOLING TOWERS

1.01 General

- A. Cooling towers or closed coolers shall be installed for all refrigeration systems using water for refrigerant condensing.
- B. All cooling towers will be mechanical draft and may be of metallic or non-metallic construction. Return water distribution may be deck or spray type. Shall be designed for EWT 96.5 degf, LWT 87 degf, Ent air wet bulb 78 degf.
- C. Towers will be installed, whenever possible, at grade level and be screened to achieve full concealment without adversely affecting performance or serviceability. Towers installed on roof of occupied buildings will be isolation mounted. Tower installment on roof will be discouraged.
- D. The elevations of tower basin and storage tank operating levels and pump suction shall be indicated on contract drawings to assure pump operation free of cavitation. Horizontal shaft pumps shall be installed inside buildings.
- E. All cooling towers operating with wet basins will be provided with sufficient heat in the recirculating circuit to avoid draining of piping during sub-freezing weather.
- F. Chemical treatment equipment shall be provided for all cooling towers.
- G. All cooling towers shall be metered as detailed in Section 230519 (Metering). Pipe AHU condensate to building cooling towers.
- H. All cooling towers shall have accessories to control the noise of the fans.
- I. Cooling towers may have VFD fans and tower modulated bypass to control the cooling tower water temperature for low ambient temperatures.
- J. Cooling towers shall be specified with stainless steel basins.

END OF SECTION

237200 VENTILATION SYSTEMS

1.01 General

- A. The term Sanitary Facilities refers to the following spaces: toilet, shower, drying and wash rooms; bathrooms; janitor closets.
- B. Mechanical exhaust systems will be installed to remove odors and moisture generated in sanitary facilities. Other spaces requiring exhaust ventilation shall not be connected to sanitary exhaust systems.
- C. The design of exhaust systems shall satisfy the following criteria:
 - 1. Rate of exhaust shall not be less than 2.0 cfm/sf.
 - 2. Corrosion resistant ceiling registers (grille with opposed blade damper) sized for a face velocity not exceeding 300 fpm shall be used and be located directly over the sources of odor and moisture (i.e., toilets, urinals, showers, hand basins and service sinks).
 - 3. Unlined collection ductwork shall be installed to permit installation of minimum number of exhaust fans. Ceiling registers shall be connected independently by branches to the main ductwork to facilitate balancing and attenuate noise transmission. Branch ducts shall be sized based on a friction factor not exceeding 0.06"/100', main ducts not exceeding 0.10"/100'.
 - 4. Exhaust fans shall be centrifugal type, preferably belt driven, selected for a wheel tip speed not exceeding 3,500 fpm and be installed whenever possible in mechanical rooms. Fans will not be installed above ceilings or other concealed or inaccessible locations. Fans shall be isolation mounted and have corrosion resistant gravity type backdraft dampers with blade edge and end seals.
 - 5. Fans shall be controlled by time clocks, energy management system if provided, or by electrically interlocking with air handling apparatus introducing outside air into the building. An accessible non-fused disconnect switch shall be installed in or adjacent to each fan base.
- D. All mechanical rooms containing heat generating equipment will be mechanically ventilated to prevent room temperature in the occupied zone from exceeding 15 degrees F above outside summer design temperature.
 - 1. Ventilation air quantity should be based on not less than six (6) air changes per hour, or not less than is required to produce an air motion of 50 fpm.
 - 2. Ventilation air shall be introduced on the cool side of the room and be relieved on the hot side so as to avoid diffusing heated air. Distribution and collection ductwork will be used, when necessary, to achieve optimum effectiveness of ventilation air systems.
 - 3. Ventilation air may be introduced directly from the outside or be relieved or transferred from adjacent spaces. Air from sanitary facilities or air containing odors or pathogens shall not be used.
- E. Mechanical rooms containing heating equipment fired with atmospheric burners will be maintained above atmospheric pressure. Doors will not be installed between these room and conditioned spaces.

- F. Modulating mixing dampers shall be installed on the inlet of makeup or supply air fans to permit continuous year-round operation. A low limit supply air thermostat with a setpoint of 60 degrees F will be provided to position the dampers. Use of unit ventilators and heating and ventilating units is permitted.
- G. The term “service facilities” refers to such temporary occupancy spaces as vending machine alcoves or rooms and telephone rooms.
- H. Service facilities will be ventilated at the rate of ten (10) air changes per hour by use of transfers or using such spaces as return air plenums. The air from these spaces shall not be exhausted from the building.
- I. No ventilation systems shall exceed the design criteria established for NOISE as noted in the ASHRAE Design Guide lines. [enough for presentation classrooms]
- J. Air to air and enthalpy wheel economizer shall be utilized on all non-toxic major ventilation exhaust system. In toxic ventilation exhaust utilize sensible heat recovery systems to temper the fresh air. In the case where the exhaust and building fresh air ductwork do not run close for a heat pipe system then a pumped heat pipe system shall be utilized.

END OF SECTION

237201 LABORATORY FUME HOODS

1.01 Fume Hoods (General and Radioisotope)

- A. All fume hood exhaust systems, except those designed for use with experiments involving perchloric or hot nitric acids shall conform to the following criteria. Consult with the Facilities Engineering Department for the latest design criteria for Fume Hoods and Fume Hood Face Velocity Controllers.
- B. Locate fume hoods on uppermost floor of building. Location on floor shall be at opposite end of room from exits, away from used walkways; door and operable windows. Coordinate location to allow exhaust duct to be run up through roof with no offsets.
- C. Each hood shall have an individual fan and exhaust duct or be connected to a manifold exhaust system. Joints in duct shall be air tight.
- D. Auxiliary air fume hoods shall have provisions for shut-off of make-up air to the hood when fume hood exhaust fan is shut off.
- E. See latest issue of Mechanical Design Criteria as published by the Board of Regents of The University System of Georgia for additional requirements.
http://www.usg.edu/ehs/guidelines/fume_design.phtml
- F. Approval for any deviation from this criteria must be obtained in writing from the Associate Vice President for Facilities and Operations, and Associate vice President for Environmental Health and Safety at Georgia Tech.
- G. An investigation of the type contaminants to be exhausted and the process involving same should proceed system design. Provide a document indicating which chemicals and estimated amount of chemical will be used in the hood. Provide this document to the Ga. Tech Facilities EPD officer.
- H. All fume hoods shall be tested by the Georgia Tech Environmental Safety Department for performance.
- I. Mechanical designers are to check with the Georgia Tech Environmental Safety Department for face velocities, cfm and testing requirements.
- J. Duct below ceiling shall be satin brushed finish with longitudinal joint ground smooth and against wall.

2.01 Fume Hood Exhaust Duct Requirements

- A. Exhaust duct shall be run vertical with no offsets permitted except at fan suction. A 90' elbow shall be used to connect duct to suction side of fan. The distance between flanges face of 90' elbow and suction flange of fan shall not exceed 6 inches in length.
- B. Fume hood exhaust duct shall extend from fan discharge flange and shall terminate above the transition zone between air moving freely past the building and the turbulent air restrained on the roof or lee side of the building and away from fresh air intakes.
- C. Exhaust ducts shall discharge straight up and provision shall be made to capture and drain the rain water which enters the stack.
- D. See latest version of BOR fume hood design criteria, otherwise duct shall be 16 gauge, type 304 stainless steel, welded with stainless steel rod. Weld longitudinal

joints in three (3) foot sections maximum and grind interior joint with flanged end connections. Grind interior joints all smooth. Provide acid resistant gaskets for flanged connections.

- E. Duct below ceiling shall be satin brushed finish with longitudinal joint ground smooth and against wall.

3.01 Fume Hood Exhaust Fan Requirements

- A. All exhaust fans serving fume hoods must be located on or above the building roof level. Fan exhaust shall extend 10 ft. above room and have an exit velocity of minimum of 3,500 ft. /min. All ganged hoods systems shall a minimum of one standby fan.
- B. Fume hood fan shall be direct drive fan complete with one-piece gray cast iron housing; cast iron paddle wheel, (stuffing box consisting of brass lantern ring with three rows of packing), flanged inlet and outlet; drain connection; explosion proof motor; weather tight motor and drive housing; and explosion proof fan disconnect switch.
- C. Fan capacities shall conform to those outlined on chart AFume Hood Air Requirements@, located in the Mechanical Design Criteria of the Board of Regents of the University System of Georgia. A minimum of 100 SFM shall be maintained at all such opening positions.
- D. All fume hoods shall have controls which constantly adjust the exhaust air to maintain 100 SFM of air across the face of the hood for all sash positions and with all activities taking place in the hood. The measurement shall be by direct measurement means such as through the wall sensors.
- E. All makeup air shall be tempered to maintain the room temperature and shall maintain a negative pressure of the lab to the adjacent spaces such as halls, labs and offices at all times under all conditions. Pressure tracing systems are the preferred method. Specify a diaphragm delta-P sensor to measure pressure differential between the laboratory and the reference space. Maintain -0.005" w.g. pressure differential. Do not specify volumetric control. Refer to Section 230900 DDC Control and Instrumentation.
- F. Georgia Tech requires to have the fume hood run 100% of the time because researchers tend to store chemicals in the hoods, therefore off/on switches are not allowed. Should they be allowed then auxiliary air fume hoods shall have provisions for shut-off of make-up air to the hood when fume room exhaust fan is shutoff.
- G. Provide heat pipe heat recovery system for fume hood exhaust.

4.01 Additional Requirements for Radioisotope Fume Hoods

- A. Duct system design must take into account allowances required by filter section installed in the exhaust duct. Check manufacturers' design data for physical dimensions of filter section.
- B. Fume hood exhaust fans must be sized to overcome static pressure losses across filter (s) in exhaust duct. See manufacturers' data and attached AFume Hood Air Requirements@ for static pressure requirements.

5.01 Fume Hoods (Perchloric and Hot Nitric Acid)

- A. Locate fume hoods on uppermost floor of building. Location on floor shall be at opposite end of room from exits, away from frequently used walkways, doors and operable windows. Coordinate location to allow exhaust duct to be run up through roof with no offsets.
- B. Each hood shall have an individual fan and exhaust duct. Joints in duct shall be air tight.
- C. Auxiliary air fume hoods shall have provisions for shut-off of make-up air to the hood when fume room exhaust fan is shutoff.
- D. See latest issue of Mechanical Design Criteria as published by The Board of Regents of the University System of Georgia for additional requirements.
- E. Approval for any deviation from this criteria must be obtained in writing from the Vice Chancellor for Construction and Physical Plant, Board of Regents of the University System of Georgia.
- F. An investigation of the type contaminants to be exhausted and the process involving same should proceed system design.

6.01 Fume Hood Exhaust Duct Requirements

- A. Exhaust duct shall be run vertical, where possible, with no offsets permitted except at fan suction. An elbow shall be used to connect duct to suction side of fan. The distance between flange face of an elbow and suction flange of fan shall not exceed 6 inches in length.
- B. Fume hood exhaust duct shall extend from fan discharge flange and shall terminate above the transition zone between air moving freely past the building and the turbulent air restrained on the roof or less side of the building and away from fresh air intakes. Configure the duct exhaust to have a minimum exit velocity of 3500 fpm.
- C. Exhaust ducts shall discharge straight up and provision shall be made to capture and drain the rain water which enters the stack.
- D. Select the most appropriate material for the application. But in the case of a general fume hood or chemical duct. The duct shall be 16 gauge 316 stainless steel, welded with stainless steel rod. Weld longitudinal joints in three (3) foot sections maximum and grind interior joint smooth. Weld sections together to form one stack length with flanged end connections. Grind interior joints all smooth. Provide acid resistant gaskets for flanged connections.
- E. Duct below ceiling shall be satin brushed finish with longitudinal joint ground smooth and against wall.

7.01 Fume Hood Exhaust Fan Requirements

- A. All exhaust fans serving fume hoods must be located on or above the building roof level.
- B. Fume hood fan shall be direct driven fan complete with one-piece gray cast iron housing; cast iron paddle wheel; (stuffing box consisting of brass lantern ring with three rows of packing), flanged inlet and outlet; drain connection; explosion proof motor; weather tight motor and drive housing; and explosion proof fan disconnect switch.
- C. Fan capacities shall conform to those outlined on chart AFume Hood Air Requirements@, located in the Mechanical Design Criteria of The Board of Regents of the University System of Georgia. All fans shall be sized to maintain a 100 SFM at any sash opening position.
- D. Ganged exhaust systems shall be designed with N+1 fans. N'total requirement, +1 'one standby fan per system.

8.01 Wash Down Requirements

- A. Provide a system of wash down spray nozzles for washing down of exhaust duct and fan.
- B. Provide water spray nozzles at the following locations:
 - 1. Top of fan discharge stack
 - 2. In 6 inch spool piece
 - 3. Dual spray nozzles in 90 deg elbows
 - 4. Fan housing
 - 5. Top of hood (supplied by hood manufacturer)
- C. Provide drain for wash water in fan housing. Provide freeze protection for drain and water pipe above roof.
- D. Provide a stop and drain valve in the heat supply line to the spray nozzles to enable draining down of the system.
- E. All pipe coming in contact with exhaust fume shall be stainless steel.

9.01 Testing and Acceptance

- A. All fume hoods shall be tested by the campus Environmental Safety Department. A certificate of acceptance shall be affixed to the fume hood upon acceptance.
- B. Consult with campus Environmental Safety Department for proper test to be performed.

END OF SECTION

**237205 BUILDING-SPECIFIC LABORATORY CONTROLS REQUIREMENTS -
FORD ES&T (147) AND U.A. WHITAKER (165) BUILDINGS**

101.1 Lab Controls Requirements

A. Work related to laboratory airflow controls in the ES&T and UA Whitaker buildings shall comply with the following requirements and standards in regards to workmanship, material requirements, pre and post construction testing, performance specifications. These standards shall be the guideline for laboratory environment, fume hoods, and fume hood face velocity controllers. Perchloric, nitric acid or other fume hoods prohibited from being connected to the building's exhaust manifold system shall be exempt from these requirements (refer to Section 237201-5.01).

B. Operating Parameter Standards:

1. Lab Occupancy: Typical occupied hours in both buildings are from 7:00 am – 10:00 pm Monday through Friday. Unoccupied hours are from 10:00 pm – 7:00 am Monday through Friday and all-day Saturday and Sunday. Laboratory spaces in these buildings include passive infrared type occupancy sensors. When the occupancy sensors detect motion, the lab status changes from “Unoccupied” to “Occupied”.

2. Lab Ventilation: laboratory spaces shall be designed for a minimum of 6 air changes per hour (ACH) during occupied hours and 4 ACH during unoccupied hours. Minimum air change rates shall be based on total exhaust airflow from each space, as calculated by the following formula:

$$\text{Lab Ventilation (ACH)} = \frac{\text{Total Exhaust Airflow (CFM)} * 60 \text{ min/hr}}{\text{Total Lab Space Volume (CF)} * 90\%},$$

3. Total exhaust airflow shall include the sum of the measured airflow through all general exhaust valves, fume hood exhaust valves, and task exhaust (snorkel, etc.). Laboratory volume shall be multiplied by a 0.9 correction factor to account for the casework in the lab environment (which reduces actual air volume within each space.) Spaces with heavy fume hood density may operate at air change rates higher than the minimums due to hood exhaust airflow requirements.

4. Lab Temperatures: refer to Sections 230900 – DDC Controls and HVAC Instrumentation and 230003 – Space Conditions for requirements. Tighter temperature dead bands during occupied hours and/or unoccupied hours can be provided where research demands.

C. Lab / Space and Task Equipment Ventilation:

1. The Contractor will be responsible to verify and confirm pre- and post-design requirements for each laboratory space involved. Refer to requirements below.

2. All task exhausts shall be equipped with a dedicated controlled isolation damper. The motorized damper shall be two-position type (on/off), actuated by a manual wall switch.

3. All labs shall be equipped with a purge button that will provide higher ACH in the lab in the event of an unanticipated temporary need for such exhaust rates.
4. Laboratory airflow controls in both buildings are volumetric offset type. New renovation work should match this type of volumetric offset control.

D. Fume Hood Requirements:

1. Airflow design criteria: fume hood face velocities in both buildings are controlled to 80 feet per minute (fpm) through the open sash area, based on a maximum sash height of 18". New renovation projects involving fume hoods shall use 80 fpm as the design criteria. The BOR has granted a variance for this setting to be applied to GESPC related work in these buildings. All fume hoods shall be capable of variable-volume operation and the associated fume exhaust controls shall vary the exhaust air volume proportionally in response to hood sash position.
2. Minimum ventilation: fume exhaust controls shall maintain a minimum of 150 ACH within the hood. Hood face velocities may exceed 80 fpm when the hood sashes are closed.
3. All fume hoods shall be connected to the manifolded building exhaust systems, with the exception of specialty hoods as described above.
4. All fume hoods shall be equipped with zone presence sensors and automated sash closers to automatically close the hood sashes after a defined time interval when no occupancy is detected. Sash closers shall include obstruction sensors.
5. All laboratory task exhaust (snorkels, etc.) shall have required airflows clearly indicated on the design drawings to allow verification during testing, adjusting, and balancing work.

E. Control Points and Naming Nomenclature:

Lab Fume Hood	Command	Yellow Book Name (8 max)
Fume Hood Face Velocity Setpoint	Read	FH01-FVS
Fume Hood Effective Velocity SP	Read	FH01-EFF-FVS
Fume Hood Face Velocity Actual	Read	FH01-FVA
Fume Hood Low Face Velocity Alarm Setpoint	Read	FH01-FVL-SP
Fume Hood Low Face Velocity Alarm	Read	FH01-FVL
Fume Hood High Face Velocity Alarm Setpoint	Read	FH01-FVH-SP
Fume Hood High Face Velocity Alarm	Read	FH01-FVH
Fume Hood Volume	Read	FH01-VOL
Fume Hood Actual ACH	Read	FH01-Act ACH
Fume Hood Min ACH	Read	FH01-min ACH
Fume Hood Airflow CFM	Read	FH01-AIRFLOW
Fume Hood Min CFM	Read	FH01-MINAIRFLOW

Fume Hood Sash Position	Read	FH01-SASHPOS
Fume Hood Sash Setpoint Closed (face velocity)	Read	FH01-SASHSP-CLOSED
Fume Hood Occ Sensor Status	Read	FH01-OCCSENS
Fume Hood Sash Closure Time Delay Value	Read	FH01-SCTDV
Fume Hood Exhaust Damper Position	Read	FH01-DMPPPOS
Fume Hood Exhaust Damper Position Setpoint	Read	FH01-DAMPSPT
Fume Hood Low DP Alarm (Venturi Only)	Read	FH-LDPA
Fume Hood Jam Alarm (Venturi Only)	Read	FH-DJAM

Lab Supply Air Valve	Command	Yellow Book Name (8 max)
Supply Valve Air Flow	Read	SV01-AFLW
Supply Valve Air Flow Setpoint	Read	SV01-AFLWSP
Supply Valve Hot Water Valve Output	R/W	SV-RHVO
Supply Valve Discharge Air Temp	Read	SV-DAT
Supply Valve Damper Output	Read	SV01-DMPO
Supply Valve Low DP Alarm (Venturi Only)	Read	SV-LDPA
Supply Valve Jam Alarm (Venturi Only)	Read	SV-DJAM
Supply Valve Air Flow Setpoint Min	Read	SV01-AFLWMIN
Supply Valve Air Flow Setpoint Max	Read	SV01-AFLWMIN

Lab Exhaust Air Valve	Command	Yellow Book Name (8 max)
Exhaust Valve Air Flow	Read	EV01-AFLW
Exhaust Valve Air Flow Setpoint	Read	EV01-EFSP
Exhaust Valve Air Flow Setpoint Min	Read	EV01-EFSPMIN
Exhaust Valve Air Flow Setpoint Max	Read	EV01-EFSPMAX
Exhaust Valve Damper Output	Read	EV01-DMPOUT
Exhaust Valve Low DP Alarm (Venturi Only)	Read	EV-LDPA
Exhaust Valve Jam Alarm (Venturi Only)	Read	EV-FVSL

Lab Snorkel	Command	Yellow Book Name (8 max)
Snorkel Valve Position (switch)	Read	SN01-ACTIVE
Snorkel Air Flow (if applicable)	Read	SN-AIRFLOW

Lab Information	Command	Yellow Book Name (8 max)
Lab Mode (Occ / Unocc)	R/W	LAB-MODE
Lab Occ Sensor Status	Read	LAB-OCCSEN
Lab Zone Temp	Read	LAB-ZNT
Lab Temp Setpoint	R/W	LAB-ZNTSP

Lab Warmer / Cooler Adjust	Read	LAB-ZNTWCADJ
Lab Effective Temp Setpoint	Read	LAB-ZNTEFFTSP
Lab Occ Temp Setpoint Deadband	R/W	LAB-ZNTOCCDB
Lab Unocc Temp Setpoint Deadband	R/W	LAB-ZNTUNOCCDB
Lab Effective Heating Setpoint	Read	LAB-ZNTEFFHTGSP
Lab Effective Cooling Setpoint	Read	LAB-ZNTEFFCLGSP
Lab Unocc Zone Temp Setpoint	R/W	LAB-TUNOCC
Lab Volume	Read	LAB-VOL
Lab Exhaust Setpoint	Read	LAB-EXHSP
Lab Exhaust Flow Total	Read	LAB-EXFL
Lab Air Change Rate	Read	LAB-AIR
Lab Supply Flow Total	Read	LAB-SUPPLY
Lab Supply Flow Setpoint	Read	LAB-SUPPLY-SP
Lab Flow Offset Setpoint	Read	LAB-FLOW
Lab Flow Offset	Read	LAB-OFF
Lab Pressure	Read	LAB-PRE
Lab Low Air Change Alarm	Read	LAB-LACHA
Lab Low Air Change Alarm Setpoint	R/W	LAB-LACHSP
Lab High Air Change Alarm	Read	LAB-HACHA
Lab High Air Change Alarm Setpoint	R/W	LAB-HACHSP
Lab Purge Button Status	Read	LAB-PURGE

F. Minimum Required Trending and data storage within the Georgia Tech Metasys Database:

1. Fume Hood Measured Face Velocity
2. Fume Hood Air Flow
3. Fume Hood Occupancy Status
4. Fume Hood Sash Position
5. Supply Valve Airflow
6. Exhaust Valve Airflow
7. Snorkel Airflow
8. Snorkel Damper Position
9. Lab Air Change Rate
10. Lab Occupancy Sensor Status
11. Lab Zone Temperature

12. Outside Air Temperature

G. Pre-Construction Testing and Documentation Requirements:

1. Provide preliminary testing, adjusting, and balancing (TAB) work for existing lab airflows prior to any renovation work. Measurements to include total supply airflow at minimum and maximum supply valve positions, and exhaust flow measurements through the general exhaust, lab exhaust, and task exhaust.

H. Laboratory Controls Manufacturers:

1. Lab controls in the ES&T building are provided by TEL and lab controls in the UA Whitaker building are provided by Triatek. Any new laboratory airflow controls shall be by the same respective manufacturers unless specifically authorized by Georgia Tech. All lab controls shall be installed by a manufacturer's certified installer.

I. Controls Graphics – Johnson Controls Interface

1. All new lab controls shall interface with Georgia Tech's Metasys front end and contain graphics consistent with the GESPC project. Trending shall be established in the Metasys UI system to be consistent with the GESPC project and shall be continuous for the duration of the GESPC contract period through June 2031.

J. Notification of ABM

1. ABM is the Energy Service Provider responsible for the GESPC work in ES&T and UA Whitaker. As such, ABM's representatives shall be made aware of any and all design efforts in the effected buildings as soon as they are known and throughout the design and construction process. Once a project request is generated and a Design and Construction manager assigned, ABM's representative (WHO W/CONTACT INFO) shall be notified by email that such a project is in design. All design document submittals shall be reviewed by the ABM representative for compliance with the GESPC project.

END SECTION

237313 INDOOR CENTRAL-STATION AIR-HANDLING UNITS

1.01 General

- A. All central air systems over 10,000 cfm supply air will be designed to introduce 100% outside air to the building during economizer mode.
- B. Designs will include motorized minimum and maximum outside air dampers and exhaust air dampers for each air system. Where the return air system pressure drop does not exceed 0.10" W.G., the return air fan may be omitted and gravity relief dampers may be used.
- C. Outside air will be drawn in through wall louvers with exhaust discharge above the room or above the intake louvers. Where intake and exhaust louvers must be installed at the same elevation, horizontal distance between louver sides will be not less than twenty (20) feet. Intakes shall not be within 20' of cooling towers and shall not be near loading docks, vehicle loading zones or service areas where garbage receptacles are located. Intakes shall be at least 10' above adjacent roadway.
- D. Dampers will be sized for a face velocity for not less than 1,000 cfm. Minimum outside air dampers will be sized for not less than 15% of supply air cfm, all others, not greater than 85% of supply air cfm.
- E. Return and outside air ductwork and dampers will be arranged to achieve complete mixing of these two air streams prior to entry into the air handling apparatus. Where complete mixing cannot be achieved, the outside air will be introduced above or below the return air so the stratification occurs only in the vertical plane. Arrange exhaust and intake ductwork side-by side where feasible to allow convenient installation of heat recovery systems.
- F. Dampers will be installed with blade shafts horizontal. An access door having a minimum clear opening of 12" x 12" will be installed adjacent to each concealed damper.
- G. Return air fans may be centrifugal or axial flow type but all will be belt driven, have lubrication fittings accessible outside the fan housing, and be selected for an outlet velocity of not greater than 2,500 fpm.
- H. A strip heating coil shall be installed at the bottom of the face side of the cooling coil to provide freeze protection. The strip heater shall be controlled by the freeze stat to operate when the freeze stat shuts down the unit for protection.
- I. All central air systems over 3000 cfm supply air shall have an economizer control installed. The controls shall modulate the return, fresh air and mixing damper to maintain a constant supply temperature. The control system shall compare the return and outside air temperatures. When the outside air is less than the return air temperature, the economizer cycle shall be activated.
- J. The ASHRAE Noise criteria shall apply to all spaces.
- K. Field assembled or factory fabricated air units may be used for systems.
- L. Building walls will be used whenever possible to form the walls and tops of housings. Sheet metal walls and casing tops will be constructed in accordance with details based on the recommendations of SMACNA. Curb anchoring will be detailed for plenums pressurized by Class II and Class III fans.

- M. Filter Sections: Air filtration shall be provided in every air handling system. Air-handling units shall have a disposable pre-filter and a final filter. The filter media shall be rated in accordance with ASHRAE Systems Handbook 2004 Chapter 24. Filter racks shall be designed to minimize the bypass of air around the filter media with a maximum bypass leakage of 0.5 percent. Filters shall be sized at 2.5 m/s (500 FPM) maximum face velocity. Filter media shall be fabricated so that fibrous shedding does not exceed levels prescribed by ASHRAE 52. The filter housing and all air-handling components downstream shall not be internally lined with fibrous insulation. Double-wall construction or an externally insulated sheet metal housing is acceptable. The filter change-out pressure drop, not the initial clean filter rating, must be used in determining fan pressure requirements. Differential pressure gauges and sensors shall be placed across each filter bank to allow quick and accurate assessment of filter dust loading as reflected by air-pressure loss through the filter and sensors shall be connected to building automation system.
- N. Plenum chambers will rest on 4" high concrete bases and be sized and arranged to permit servicing and repair of fans and filters, and replacement of finned tube coils. Each chamber will be lighted and have an access door not smaller than 24" x 48". Access doors will be provided with safety latches and be hinged to swing into the area of highest static pressure. Fan shutdown switches will be provided inside casings pressurized by Class II and Class III fans.
- O. Cooling coils will be mounted vertically in a straight line with tubes perpendicular to air flow.
 - 1. Coils will be independently supported on galvanized structural frames. Coils: Individual finned tube coils should generally be between six and eight rows with at least 2.1 mm between fins (12 fins per inch) to ensure that the coils can be effectively and efficiently cleaned. Dehumidifying coils shall be selected for no more than negligible water droplet carryover beyond the drain pan at design conditions. All hot water heating and chilled water cooling coils shall be copper tube and copper finned materials. Equipment and other obstructions in the air stream shall be located sufficiently downstream of the coil so that it will not come in contact with the water droplet carryover. Cooling coils shall be selected at or below 2.5 m/s face velocity (500 fpm) to minimize moisture carryover. Heating coils shall be selected at or below 3.8 m/s face velocity (750 fpm).
- P. Intermediate condensate drain pans, projecting not less than 12" downstream of coil frames, constructed of stainless steel or monel, will be installed between each coiled section with vertical copper drain lines to carry condensate to floor pan.
 - 1. Block off sheets of 24 gauge galvanized steel will be installed with caulking to prevent air bypass and leakage. Condensate drains will be trapped.

- Q. UVC Emitters/Lamps: Ultraviolet light 8 band emitters/amps shall be incorporated downstream of all cooling coils and above all drain pans to control airborne and surface microbial growth and transfer.
1. Irradiation - Emitters and fixtures are to be installed in sufficient quantity and in such an arrangement so as to provide an equal distribution of UVC energy on the coil and in the drain pan. To maintain energy efficiency, the UVC energy produced shall be of the lowest possible reflected and shadowed losses.
 2. Intensity - The minimal UVC energy striking the leading edge of all the coil fins shall not be less than 1500 μ W/cm². This sets the quantity of fixtures to be installed and their placement. The emitter tube shall be of the high output, hot cathode, T5 (15mm) diameter, and medium bi-pin type. They shall produce 95% of their energy at 254 nm and be capable of producing the specified output at airflow velocities to 1000 fpm at temperatures of 35 - 170 \square F.
- R. Output Verification: When tested in accordance with the general provisions of IES Lighting Handbook, 1981 Applications Volume, total output per one inch arc length shall not be less than 10 MBOL109\rf"Symbol"\s12W/cm², at one meter, in a 400 fpm airstream of 45 \square F Applied fixtures/lamps must be specifically manufactured for this purpose. Safety interlocks/features shall be provided to limit hazard to operating staff.
- S. Access Doors: Access Doors shall be provided at air handling units downstream of each coil, upstream of each filter section and adjacent to each drain pan and fan section. Access doors shall be of sufficient size to allow personnel to enter the unit to inspect and service all portions of the equipment components.
- T. Coil face velocity shall NOT greater than 500 fpm.
- U. Plenums containing cooling coils will be wide enough to fully enclose coil end turns and headers, and provide clearance between coiled surfaces and plenum insulation.
- V. Heating coils in blow-through, dual-deck apparatus will be baffled or installed downstream of cooling coils at least 24" to prevent weeping.
- W. Piping risers will be offset from coils and be provided with unions to facilitate removal of coils. Bottoms of risers will have drain valves; tops, manual vent valves.
- X. Fans mounted on grade and those on above grade floors will be isolation mounted. Fan motors greater than 7.5 hp should be premium high efficiency models.
- Y. Install a permanent monitoring system to ensure that ventilation systems maintain design minimum requirements. Configure all monitoring equipment to generate an alarm when the air flow values or carbon dioxide (CO₂) levels vary by 10% or more from the design values via either a building automation system alarm to the building operator or a visual or audible alert to the building occupants. AND Monitor CO₂ concentrations within all densely occupied spaces (those with a design occupant density of 25 people or more per 1000 s.f.). CO₂ monitors must be between 3 and 6 feet above the floor. Provide a direct outdoor air flow measurement device capable of measuring the minimum outdoor air intake flow with an accuracy of plus or minus 15% of the design minimum outdoor air rate, as defined by ASHRAE 62.1-2007 (with errata but without addenda) for mechanical ventilation systems where 20% or more of the design supply airflow serves no densely occupied spaces.

END OF SECTION

238123 COMPUTER ROOM AIR CONDITIONING UNITS

1.01 Computer Rooms and Controlled Environment Labs:

- A. There are many small computer rooms and controlled environment labs required at Georgia Tech. These facilities require much more rigid control of both temperature and humidity than is required for comfort conditions in the remainder of the building.
- B. All computer rooms and controlled environment labs shall be designed with air conditioning equipment completely independent of the primary building system. Air conditioning systems designed SPECIFICALLY for close control of temperature and humidity shall be specified. The systems will provide for cooling, humidification, dehumidification, and reheat.
- C. Consideration should be given to the energy consumption of these units. Innovation for heat reclaim and free cooling should be considered if the components themselves have proven reliability.
- D. Down flow units feeding through a raised floor are desired. Where practical, multi-stage units should be specified.
- E. Remote air cooled system should be considered. Condenser shall be variable fan speed control type. No water cooled system that rejects heat to building chill water distribution system is acceptable.
- F. All computer room and controlled environment equipment shall automatically restart after a loss of power.
- G. There will be zero use of chlorofluorocarbon (CFC) – based refrigerants in new base building HVAC systems. When reusing existing HVAC equipment, complete a comprehensive CFC phase-out conversion prior to project completion. Phase-out plans beyond the project completion date will be considered on their merits.
- H. Select refrigerants and HVAC &R that minimize or eliminate the emission of compounds that contribute to ozone depletion and global climate change. The base building HVAC&R equipment must comply with the following formula, which sets a maximum threshold for the combined contributions to ozone depletion and global warming potential: $LCGWP + LCODP * 10^5 \leq 100$
- I. All heating and cooling coils shall have a pressure gauge and temperature gauge on the piping, entering and leaving the coil.
- J. Cooling coil condensate, where ever feasible run the cooling condensate to a holding tank outside of the building for irrigation or back to the cooling tower.

END OF SECTION

238233 HEATING SYSTEMS

1.01 General

- A. Supplementary heat should be considered for the following purposes:
 - 1. To prevent down drafts at windows.
 - 2. To limit supply heating air temperature to 105 degrees F.
 - 3. To provide heating at entrances.
 - 4. To permit systems serving exterior rooms to supply air below room temperature year-round.
- B. Supplementary heat will be installed under glass when the glass area exceeds ten (10) percent of the wall area. The heaters shall be sized for 75% of glass transmission heat loss or be of sufficient capacity to limit supply air temperature to 105 degrees F. Electric heaters shall have self-contained thermostats. Hot water heater capacity shall be regulated by varying the water temperature by change in outdoor temperature.
- C. Forced convection heaters sized for 130% of transmission heat loss will be installed at main entrances. Natural convection heaters sized for 100% of transmission heat loss will be installed at secondary entrances.
- D. All supplementary heat installed in air conditioned spaces shall be de-energized automatically during summer operation.
- E. Boilers/Hot water heating systems.

2.01 Hot Water Boilers

- A. New boilers shall be the modular, condensing type, operated on natural gas. Boilers should be equipped with the following features as minimum:
 - 1. Turndown ratio of 10:1.
 - 2. Category IV direct vent capability to 100'
 - 3. Gasket-less design
 - 4. Spark ignition
 - 5. ASME Stainless steel heat exchanger
 - 6. Modbus or BAC Net communication port
 - 7. ASME stamp
 - 8. Up to 96% efficiency
- B. All boilers/hot water heaters shall have a Low-NOx@ burners are required, as a minimum, for boilers installed at GT, per the new EPA/EPD regulations. Additionally, sizing of boilers must be considered. Individual boilers must be rated under 10 million BTU's each to preclude additional and more stringent permitting procedures. All boilers and large water heaters shall be sized to operate at rated capacity with natural gas and/or air-propane mixture with a specific gravity of 1.3 and 1,350BTU/cubic foot in the same fuel train. The maximum low NOx rating shall be 30ppm of NOx for natural gas and air-propane mixture. See Section 238234 EPA Title V Requirements. Boilers that work best have O2 trim.

- C. Each construction contract that installs or replaces any boiler/hot water heater that is connected to the Georgia Tech natural gas system shall arrange with the Georgia Tech O&M Steam Plant to test the boiler/hot water heater as per the following procedure.
1. Tune the boiler/hot water heater/generator on natural gas. Record all the tuned settings. Label them Natural Gas Tuned Settings.
 2. Schedule with the Georgia Tech Steam Plant to provide air-propane needed to replace the natural gas. Allow enough time for the natural gas or air-propane mixture to reach the appliance you are testing. Tune the boiler/hot water heater/generator on air-propane. Record all the tuned setting. Label them as Air-Propane Tuned Setting.
 3. Re-tune the boiler/hot water heater/generator to midway between the Natural Gas Setting and the Air-Propane Tuned Settings. Record these setting as Mid Natural Gas and Air- Propane Settings.
 4. Test the boiler/hot-water heater/generator to relight on BOTH the Air-Propane mixture and natural gas. Allow enough time for the natural gas or air-propane mixture to reach the appliance you are testing.

END OF SECTION

238234 EPA TITLE V REQUIREMENTS

1.01 General

- A. Since January 1, 2004, the 18 county Atlanta metro area has been designated by the Federal EPA to be a severe attainment area. This means that EACH AND EVERY SYSTEM that burns or consumes fossil fuels shall meet the same NOx emissions standards as Los Angeles, CA. EPA Title V requirements.
- B. Because Ga. Tech has exceeded its 25 tons of NOx that it has been allotted each new project has to submit to the State of Georgia EPA the projected emissions for a new source review. Each project will be required to purchase NOx allotments to offset the project's impact on Georgia Tech NOx allocation.
- C. Each gas fired device shall be purchased with the (BACT) Best Available Control Technology. The limits of emissions are a moving target and change with time. As of the writing of this section the following limits of emissions apply.
 1. Boilers and hot water heaters that have a potential to emit greater than 1 ton of NOx annually shall have a NOx emission rating of less than 30 ppm.
- D. Emergency standby generators with capacities of > 35 kW shall be equipped with a system which limits NOx emissions to 1.5 grams/hp-hr or less. This unit shall meet the EPA Title V for S.C.A.Q.M.D requirements. The contractor shall provide manufacturers data sheets to confirm before ordering.
- E. Each piece of fuel burning equipment (emergency standby generators excluded) having a potential to emit greater than one ton of NOx emissions annually shall be re-tested and re- certified for proper combustion and emission tuning between the dates of February 1 and May 1, annually. Therefore, if a project starts up a boiler or hot water heater, having a potential to emit greater than one ton of NOx emissions annually, prior to May 1 of a calendar year, then the boiler or water heater shall be tested and certified for proper combustion and emission tuning between the dates of February 1 and May 1, of that calendar year.

END OF SECTION

260000 – ELECTRICAL

1.01 General

A. Scope

1. This Division contains design and construction requirements for electrical aspects of construction and renovation projects for Georgia Tech and is intended for use by engineers involved in such projects. Design criteria established by the Board of Regents also apply. Refer to the project program for electrical requirements in addition to those of this section.
2. The engineer is expected to use the Engineer's own specifications and to provide design work in accordance with standard practice subject to the requirements stated in this guide.
3. This document does not address all aspects of electrical construction. It addresses only those items for which Georgia Tech Facilities has a specific standard, preference, or methodology.

B. Codes and Standards

1. All materials and work shall comply with the codes currently established by or adopted by the State of Georgia as well as standards and guidelines set forth by the Board of Regents of the University System of Georgia.
2. All materials shall comply with all applicable national standards. Materials shall be UL listed and labeled where UL listing is established for any specific product.
3. The physical execution of electrical work shall comply with applicable NECA National Electrical Installation Standards.

C. General:

1. Certain work elements such as metering and medium voltage electrical distribution are additions to existing campus systems. Additions to such systems shall comply with campus standards and shall not degrade the existing systems in any way.

D. Design:

1. The Electrical Engineer shall ensure that construction documents are complete including architectural, civil, structural, landscape, mechanical and fire protection design aspects which affect or support electrical systems and equipment. Examples include but are not limited to civil design work related to medium voltage duct banks and manholes, structural design of transformer vaults, and coordination with landscape and architectural design to achieve proper clearances at equipment.

E. Critical Applications:

1. As used in this Division, "critical applications" are those applications in which an electrical failure or outage would disrupt the operation of research laboratories, clean-rooms, telecommunications head-end, CATV backbone, network backbone, voice over IP, campus computer resources, or utilities for such spaces or other essential areas or processes.

2.01 Products

(not used)

3.01 Execution

- A. Electrical systems must be designed with flexibility in mind so that the systems will accommodate changes in the electrical requirements of the occupants over the life of the building. Consider potential future alterations and additions and design the electrical system to minimize the need for future major equipment upgrades and to facilitate future work with minimal outages.
- B. Adequate space shall be allocated for proper and safe installation, operation and maintenance of electrical systems.
- C. Electrical system reliability and power quality are critical to many research programs as well as the operation of many campus departments. Give proper consideration to these issues in designing electrical systems.
- D. Design the work so that it is constructible with a minimum of outages. Maintain critical applications in service during all work. Furnish, connect and operate temporary power systems as needed in order to meet this requirement.
- E. Specify appropriate means of protection for surrounding areas, electrical equipment and fire alarm system components and wiring to minimize the disruption of campus activities and to minimize the loss of fire detection in campus facilities.
- F. Physical arrangement of the electrical system and selection of equipment shall be designed to minimize the potential for EMI problems. Consider distances between system components and potentially sensitive areas. Choose equipment locations, equipment types and options, and wiring methods to minimize EMI. Employ EMI reduction methods such as shielding as needed.
- G. Where equipment, fixtures, wiring and/or raceways are left unused by the work of the project, or where such items exist in the space and are not used by the project, remove all such materials to the fullest extent possible unless Facilities Design and Construction designates certain items to remain. Breakers in switchgear, switchboards and panel boards left unused shall be turned off and marked "SPARE". Provide additional wiring, equipment and work as needed to accomplish the removal and to leave remaining equipment, fixtures, and wiring in service and operating.
- H. Power systems associated with spaces in which sensitive equipment will be used shall be designed in accordance with IEEE 1100 as well as other requirements of this section. The engineer shall be responsible for determining the characteristics of equipment to be connected or expected to be used in each space and shall design and specify the electrical system in accordance with the referenced standards.
- I. Temporary Services
 1. The contractor shall be responsible for establishing temporary service for use in construction projects. Temporary services may be obtained from Georgia Power Company (GPC) where lines are accessible or may be obtained from Georgia Tech distribution facilities. Where GPC service is used, the contractor shall make all arrangements directly with GPC. Where temporary service is derived from Georgia Tech lines, work shall comply with the NEC. The contractor shall provide and install all cable, conduit, transformers, metering and other equipment for the temporary service. Energy metering is required and shall be furnished by the contractor. Submit plans for review by Facilities

Design and Construction for each temporary service where connection to Georgia Tech lines is proposed. Such services shall not be constructed without approval from the office of Facilities Design and Construction. All costs of temporary service construction as well as the cost of electricity usage shall be the responsibility of the contractor. Temporary service facilities shall be completely removed at the completion of the project. Where vaults or manholes are cut for temporary service connections, remove conduits and patch holes with cement mortar.

J. Outages

1. Outage work affecting portions of the campus or building(s) not solely occupied by the contractor shall be scheduled after hours and on weekends and holidays. Such outages shall be requested in writing by the contractor and are subject to the approval of the office of Facilities Design and Construction. Requests shall be submitted at least three weeks prior to the start of the proposed outage.

K. Testing and Calibration

1. All protective devices shall be calibrated, set and tested as a part of the construction contract. Device settings shall be in accordance with the Short-Circuit and Coordination study.

L. Security of Electrical Equipment

1. Provide Best 7-pin interchangeable-core padlocks complying with the campus keying system and with shackle sizes to fit each application. Equipment without padlocks in place shall not be energized. Examples of equipment requiring padlocks include, but are not limited to:
 - a. Medium-voltage switches
 - b. Pad-mounted transformers
 - c. Unit substation transformers
 - d. Transformer and switch vault doors and hatches
 - e. Outdoor low-voltage electrical equipment accessible to the public

M. As-built Prints and Documentation

1. Complete documentation consisting of all operating and maintenance manuals for equipment, as-built prints, short-circuit and coordination study reports and arc-flash hazard study reports shall be delivered to the Owner. Use Georgia Tech medium-voltage transformer, cable, and switch and manhole numbers in identifying documentation and test reports.

END OF SECTION

260513 – MEDIUM VOLTAGE CABLE

1.01 General

- A. Application:
1. This Section includes requirements for medium voltage cables used in the campus medium voltage electric distribution system.
 2. Projects other than medium voltage distribution system projects that utilize medium voltage cables shall comply with applicable portions of this Section.
- B. Contractor Qualifications:
1. The following requirements shall appear in the project specifications. Contractor and subcontractor personnel who do not meet these requirements shall not be permitted to receive, handle, install, splice or test medium voltage cables
 - a. The contractor or sub-contractor directly responsible for the receiving, handling and installation of medium voltage cable shall have had at least three years' experience in performing similar work in underground ductbank and manhole systems. Submit references consisting of project names, dates and contact person names and telephone numbers for at least three similar projects within the past three years. Projects used as references must include the installation of medium voltage cable of the 25kV class or higher (5kV class for projects involving only 4160V circuits) in underground ductbanks and manholes. URD or other work not involving ductbanks and manholes will not be accepted.
 - b. The contractor shall the submit proof that the each cable splicer has had at least three years of experience in splicing EPR and PILC cables rated in the 25kV voltage class This proof is required before any splicing may proceed and shall consist of at least three references with contact names and phone numbers. Where PILC splices or terminations are required, references shall include at least three projects in which PILC splices or terminations were made.
 1. Exception: PILC experience is not required for projects in which no PILC cable will be installed, spliced or terminated.
 - c. Acceptance-testing of medium voltage cable and terminations shall be performed by a qualified electrical service and testing company. The service and testing company shall be one which performs electrical testing services including testing of medium voltage cable as a regular component of its business and which has been in the business of testing medium voltage cables for at least three years. The service and testing company shall not be a part of any business entity responsible for the supply and installing medium voltage cable under this contract. All test results shall be certified by an electrical engineer employed by the testing company. The engineer shall interpret the results and shall sign each test report. Test equipment used shall have been calibrated within the 12 month period immediately preceding the test date. Certification of calibration within this time period is required and shall be furnished with the test reports. Test reports furnished without this certification or tests

made with equipment without the required certification are invalid and will not be accepted.

C. Design

1. The number of splices shall be minimized. Select splice points as needed to facilitate cable installation and as needed for taps and connections. Place splices at locations within manholes to permit future replacement of splices by cutting and re-racking the affected cable along a shorter path through the manhole. Where cables pass through manholes un-spliced, rack along the longest route through the manhole where space limitations permit.
2. Medium voltage cable configuration shall be three single conductor cables and ground in a single conduit except as noted for PILC cables.
3. See Section 261000.

D. RECORD PHOTOGRAPHS

1. After installation of cable, arcproofing and tags, take a minimum of four photographs in each manhole in which new cable and/or splices were installed. Take additional photographs as needed in order to show all manhole interior walls.
2. The minimum acceptable resolution is 2048x1536.
3. Photographs shall be in color.
4. Photographs shall be sufficiently in focus and with adequate lighting so that cables and conduits are clearly recognizable.
5. Photographs shall be in .jpg format.
6. Arrange all photographs for each manhole in a subdirectory using the manhole number as the subdirectory name.
7. Photograph filenames shall be constructed as follows:
 - a. MMMDDNN.jpg where
 1. MMM is the manhole number
 2. DD is the direction the photographer is facing when taking the shot, I.E. N, S, E, W or NE, SE, SW, NW
 3. NN is a sequence number starting with 1 for each direction.
Example - if there are two photographs of the north wall in manhole 66, the filenames are 066N1.jpg and 066N2.jpg and are stored in subdirectory 066.
8. Deliver photographs to the Owner and Engineer on CD or thumb drive.

2.01 Products

A. Standards:

1. Comply with ICEA S-93-639 / NEMA WC74, AEIC CS8 and UL 1072.

B. Cable

1. Medium voltage cable shall be single conductor copper, EPR insulated with copper tape shield and overall jacket, type MV-105.

1. Exception: Where necessary to extend existing PILC, cable shall be copper, three- conductor compact sector, type H, PILC with high viscosity polybutene impregnant, and PVC jacket.
 2. Cable sizes for campus medium voltage distribution are:
 - a. Feeders and Loop Cables: 500MCM
 - b. Laterals: 4/0
 - c. High-ampacity feeders, high density ductbanks or deep ductbanks: 750MCM and 1000MCM as determined by thermal analysis.
 3. Insulation level:
 - a. Cables for 19.8kV applications shall be 25kV 100%, 260 mil. 25kV 133% 345 mil is acceptable subject to conduit size limitations.
 - b. Cable for 13.2kV applications shall be 15kV 100% 175 mil or 15kV 133% 220 mil.
 - c. Cable for 4.16kV applications shall be 5kV 133% 115 mil.
- C. Solid Dielectric Cable Terminations
1. Terminations at dead-front equipment shall be separable single-pole insulated connectors complying with IEEE 386. Connector bodies shall be equipped with capacitive test points. Connector bodies shall be fully shielded and suitable for submerged operation.
 - a. Dead-front terminations for general use on the 19.8kV system shall be 600A dead- break, 25kV, 125kV BIL, equal to Elastimold K656LR.
 2. Terminations for aerial and live-front applications shall be engineered kits consisting of non- tracking outer insulations, stress relief and environmental sealing. Terminators shall be heat shrink or molded rubber. Outdoor terminators shall include skirts. Connectors for outdoor terminators shall be environmentally sealed.
 3. 200A interfaces are not adequately rated for the expected future available short circuit currents on the campus 19.8kV system. 200A interfaces are not acceptable for general use on the 19.8kV system. In applications other than campus electrical distribution and where necessary, provide 200A interfaces at existing equipment having 200A bushings. 200A elbows, arresters and bushing inserts or reducing tap plugs shall be 200A loadbreak type. Connector bodies shall have capacitively coupled test points. Obtain approval from Facilities Design and Construction before specifying 200A interfaces.
 4. All terminations shall be equipped with environmental seal kits to seal cable jackets. Coordinate environmental seals and grounding adapters, braids or straps.
 5. Ground braids shall include solder plugs to prevent migration of moisture through the braid when correctly installed with an environmental jacket sealing kit.
- D. Solid Dielectric Cable Splices:
1. Where space permits, make splices with dead-break elbow connectors with test points. Connector bodies shall be equal to Elastimold K656LR. Elastimold

Vault Stretcher and in- line heat shrink splices are acceptable where space is inadequate for elbow splices.

- a. Where Elastimold products are used, connecting plugs shall be Elastimold K651CP. K650CP is not acceptable.

E. PILC Splices and Terminations

1. Splices shall be fabricated from manufactured kits including lead sleeves, insulating compound, tapes, connectors, oil stops and all other necessary materials. All splices must be completely enclosed in lead sleeves sealed to the cable sheaths with lead wipes. Connectors used in splices shall be compression type with tapered ends and brazed plug oil stops. Splices shall be designed to maintain the full current carrying rating, insulation level and temperature rating of the cable being spliced.
 - a. Splices with heat shrink, cold shrink, or other outer coverings and without lead sleeves will not be acceptable for use on PILC cable.
2. Transitions from PILC to solid-dielectric cables shall be accomplished with cable transition modules. Cable transition modules shall be as manufactured by Patton and Cooke and shall be in accordance with the following:
 - a. Cable transition modules shall have three bushings for ANSI/IEEE 386 compliant separable dead-break connectors and provisions for terminating PILC cable within a bolted metallic housing sealed to the PILC cable sheath(s) with a lead wipe(s). Cable transition modules shall be submersible units manufactured specifically for connecting PILC to solid dielectric cables.
 - b. Separable connectors for the connection of solid dielectric cables shall be 600A dead- break with test points, Elastimold K656 or equal.
 - c. Cable transition modules shall consist of a cast silica-based thermal setting resin, vacuum-cast and having an encapsulated copper ground screen below the module surface. Bushings shall be equipped with grounded external metallic rings. All studs and inserts including those for attachment and mounting bolts shall be bonded to the internal ground screen. PILC cable terminating space shall be enclosed by a bolted and gasketed metallic housing equipped with a wiping sleeve (3-conductor PILC cable) or set of three sleeves (single-conductor PILC cable) and means for filling with potting compound. Potting compound shall be as recommended by the manufacturer for the intended use.
 - d. Shielding shall comply with IEEE 592.
 - e. Cable transition module ratings:
 1. 25kV voltage class, 125kV BIL
 2. 600A continuously
 3. 40kV AC 1 minute withstand
 4. 78kV DC 15 minute withstand
 5. 25kA short time

F. Fault Indicators

1. At pad-mounted and subsurface switches: 3-phase fault powered, test-point reset with remote 3-phase indicator, SEL 3TPR3 0400 IR.
 - a. For switches on feeders N7, N8 and L5: SEL 3 TPR 3 0800 IR.
2. At transformers: Single-phase fault powered, test point reset, SEL 1 TPR I 0400 IR.

G. Arc-Proofing Tape

1. Intumescent arc and fireproofing tape designed for protection of electrical cables, 3M Scotch 77 or equal. Application of arc-proofing tape shall not reduce cable ampacity. Furnish with the manufacturer's recommended binder tape.

H. Temporary End Seals

1. Cable end seals shall be heat-shrink type cross-linked polyolefin end caps with internal factory-applied hot-melt adhesive mastic. Cable end seals shall be designed for direct burial in accordance with ANSI C119.1, 1986. Cable end seals shall be equal to Raychem type ESC.

3.01 Execution

A. Cable Handling: The following requirements shall appear in the project specifications:

1. Medium voltage cables shall be handled as specified herein and in accordance with the manufacturer's instructions. Where similar work is addressed by the manufacturer's instructions and in these requirements, the more stringent requirement shall apply.
2. Reels shall be shipped upright and stored upright in locations where the flanges will not sink or otherwise allow weight to rest on the cable's surface. Reels shall not be laid on sides.
3. Reels shall be lifted by a shaft through the arbor holes or by cradles or forks oriented perpendicular to the flanges and contacting both flanges. Under no circumstances may any lifting device be allowed to contact cable surfaces.
4. Where reels are rolled, secure cables and roll in direction to prevent loosening of cables on reels. Apply force only to reel flanges.
5. Exercise care in all phases of cable handling and installation to prevent deformation, abrasion, and other damaging effects.
6. Medium voltage cables shall not be bent sharper the greater of the manufacturer's recommendation or 12 times the cable outside diameter. Care shall be exercised to prevent damage to the cable sheath, conductor or insulation due to nicking, excess pulling tension, or deformation. Where cables are bent at a smaller radius than that specified, the affected cables shall be replaced by the Contractor at no additional expense to the Owner.
7. Where cables are to be pulled through manholes or enclosures, sheaves of suitable radius shall be used to prevent bending the cables sharper than the minimum specified above. Conveyor sheave assemblies having at least one roller for each 20° of bend are acceptable.

8. Medium voltage cables shall be pulled with a swivel and manufactured cable pulling eyes attached to the conductors. Basket grips shall not be used.
 9. Where mishandling occurs or where evidence of mishandling is found, the affected cables shall be replaced by the Contractor at no additional expense to the Owner. Any cables not handled in accordance with these specifications and the referenced documents shall be considered to be mishandled.
- B. Cable Dryness: The following requirements shall appear in the project specifications.
1. Medium voltage cables shall be inspected on receipt for the presence of moisture. Cables found to contain moisture shall be replaced or dried as specified herein.
 2. Medium voltage cables shall be protected from the entrance of moisture during pulling operations.
 3. Install cable end seals immediately on receipt of dry cable or immediately following drying operations. Install cable end seals immediately following any cutting or pulling operation. Cables found without end seals in place shall be purged as specified herein.
 4. Medium voltage cables found to contain moisture or which have been left unsealed shall be dried by purging with dry nitrogen having a dew point of - 60°C. Purge cables for a minimum of 6 hours for shields and 6 hours for conductors from one end with an indicating desiccant and bag in place at the other end. Purge cable shields and cable conductors separately. Repeat cycle as necessary to prove dryness. Cables shall be purged for as long as necessary to achieve this requirement. Cables will be accepted as dry when desiccants show no indication of moisture after a continuous 6 hour run. Cable purging shall comply with the cable manufacturer's instructions. Cables requiring drying shall be purged at no additional cost to the Owner.
- C. Splices and Terminations
1. Connector bodies, terminators, connecting plugs, dead-end caps, elbow arresters and other molded components shall be grounded by means of bare copper drain wires sized not less than #14 AWG. Provide larger conductors where recommended by the component manufacturer. All drain wires shall be connected to the same grounding conductor that is used to bond the cable shields. Connections shall be made with UL listed connectors suitable for the application. All such connectors used in below-grade enclosures, manholes and vaults shall be suitable for direct burial.
 2. Cable Transition Modules: Support cable transition modules on the manufacturer's bracket designed for the application. Furnish galvanized steel brackets designed to position transition splices as shown or noted on the drawings. Where no other direction is given, furnish brackets to mount cable transition modules horizontally on manhole and vault walls.
- D. Fault Indicators:
1. Remote 3-phase fault indicators: Install one set on each switched way of all switches.
 2. Integral single-phase fault indicators: Install three at each transformer.

- E. Arc-proofing:
 - 1. Arc-proofing material shall be applied to new cables where exposed in manholes and vaults and to portions of existing cables exposed in manholes and vaults where displacement of existing arc-proofing occurs during the work of the contract. Three phases and ground conductor of one feeder, loop cable or lateral shall be arc-proofed together except that cables shall be broken out and individually wrapped at splices and terminations. Apply in one layer, half-lapped except as recommended by the manufacturer. Binder tape shall be as recommended by the manufacturer.
- F. Testing
 - 1. New cable, splices and terminations shall be subjected to very low frequency (VLF) acceptance testing.
 - a. Existing cable shall not be subjected to VLF or DC high potential testing.
 - 2. Testing shall be performed by a qualified electrical testing company. Testing shall be furnished as part of the construction contract.
 - 3. Test results shall be interpreted and certified by a qualified test engineer. Results, interpretation and certification shall be delivered to the Owner prior to energizing any new cable.
 - 4. Test voltage levels shall be coordinated with cable ratings and with the ratings of all associated splices and terminations and the ratings of any connected equipment.
 - a. D.C. high potential testing is not an acceptable substitute for VLF testing.

END OF SECTION

260519 – 600V CONDUCTORS AND CABLES

1.01 General

A. Scope

1. This Section includes requirements for conductors and cables used in power systems rated 600V and less.

2.01 Products

- #### A. Use only copper conductors, #12 AWG minimum for power wiring except that fixture whips may be smaller as permitted by the NEC.

3.01 Execution

- #### A. Wire in conduit is the preferred wiring method for general use.

1. MC cable is acceptable for cost savings.
 - a. MC cable shall not be used as feeders within critical facilities.
2. MC cable with continuous corrugated aluminum sheath and three symmetrical grounding conductors shall be used for certain VFD applications as described in Section 262923.
3. Manufactured wiring systems shall not be used except within modular partition systems.

- #### B. Except as permitted below, 120V receptacle circuits shall include individual neutrals. Do not install 120V receptacles on multi-wire branch circuits except as permitted below.

1. Exception: Shared neutrals are acceptable in manufactured wiring systems in modular furniture. Such circuits shall comply with NEC 210.4 and 240.15(B).

- #### C. Comply with NECA 1.

END OF SECTION

SECTION 260526 – GROUNDING AND BONDING

1.01 General

- A. Scope
 - 1. This Section contains requirements for grounding and bonding in low-voltage and medium- voltage power systems.

2.01 Products

- A. All grounding conductors shall be copper.
- B. Grounding conductors used in the campus 19.8kV distribution system shall be 2/0 minimum, copper.
- C. Connections of campus medium-voltage distribution system grounding conductors in manholes and vaults shall be made with exothermic weldments, Cadweld or equal, or with compression connectors UL listed for direct burial.

3.01 Execution

- A. Install an equipment grounding conductor in all low-voltage feeders and branch circuits. This equipment grounding conductor shall comply with Section 260519 and is in addition to any grounding path provided by conduit, raceway, cable tray, cable shield or cable sheath.
- B. In buildings with 480/277 supply voltage, provide one or more common grounding electrode conductors near 480V distribution panels to facilitate grounding of future separately derived systems. Common grounding conductors shall be 3/0 or larger.
- C. Provide a telecommunications grounding riser for telecommunications MDF and IDF(s). Provide a ground bar on each backboard. Coordinate with telecommunications design.
- D. A 600V insulated ground conductor shall be installed with each set of medium-voltage cables. In manholes and vaults, the ground conductor shall be routed continuously with the associated feeder phase conductors. The ground conductor shall be bonded to the manhole or vault ground by means of a bonding jumper wherever medium voltage cables are spliced.
- E. Install a bare copper ground conductor around the inside perimeter of each manhole and vault, approximately 6” above the floor. The grounding conductor shall be secured to the walls and shall be connected to form a ring. The ground ring shall be connected to a minimum of three ground rods spaced as far apart as practical within the manhole or vault.
- F. Bond all medium voltage cable shields, medium voltage feeder, loop and lateral grounds, racking and other metallic parts of manholes and vaults to the ground ring.
- G. Install a buried copper ground ring around each medium-voltage equipment pad. Install a minimum of three ground rods and connect to the below-grade ground ring. Where two medium-voltage equipment pads are located 10’ apart or less or where equipment door swings are 10’ apart or less, below-grade ground rings of such equipment pads shall be interconnected.

END OF SECTION

SECTION 260533 – RACEWAYS AND BOXES

1.01 General

- A. Scope
 - 1. This Section contains requirements for raceways and boxes for low-voltage power systems in indoor and outdoor locations.
 - 2. This Section includes requirements for raceways and boxes for medium voltage systems in indoor locations.
 - 3. See Section 260543 for underground medium voltage systems.

2.01 Products

- A. Conduits and Raceways:
 - 1. Indoor and above-grade outdoor applications – metallic conduits, type EMT, IMC, RGS, FMC, LFMC as permitted by the National Electrical Code.
 - a. EMT shall not be used for medium voltage wiring.
 - b. EMT shall not be used where subject to physical damage.
 - c. All power wiring in the Holland Central Plant and the 10th St. Chiller Plant shall be in RGS. IMC shall not be substituted for RGS for work at either of the plants.
 - 2. Exposed raceways in finished areas shall be used only where concealment is not possible or where specifically required by the project program.
 - 3. Surface raceway systems shall be metallic and shall be no smaller than Wiremold 500.
 - 4. Below-grade low-voltage wiring shall be installed in type PVC schedule 40 or schedule 80 conduit as permitted by the NEC.
 - a. Incoming underground feeder conduits to main distribution equipment shall be concrete encased.
 - b. RGS ells may be used where conduits turn up at equipment.
 - 1. RGS ells shall not be used at pad-mounted transformers or at transformer vaults.
 - 5. All power wiring in the Holland and 10th St plants shall be installed in RGS conduit. Do not substitute other types.
- B. Boxes:
 - 1. Boxes for general use shall be as permitted by the NEC.
 - a. Outdoor below-grade boxes shall be polymer concrete, Quazite or equal with cover logo “ELECTRIC” and bolted covers.

3.01 Execution

- A. Comply with NECA 1 and NECA 101.

END OF SECTION

SECTION 260543 – UNDERGROUND DUCTBANKS, MANHOLES AND VAULTS

1.01 General

A. Application:

1. This Section addresses ductbanks, manholes, subsurface switch vaults and subsurface transformer vaults for the campus medium voltage electrical distribution system.
 - a. All medium voltage distribution cable shall be installed un an underground ductbank and manhole system.
 - b. Transformer vaults are required for network transformers.
 - c. Transformer or switch vaults are required in primary loop distribution only in special cases where subsurface equipment is necessary in lieu of pad-mounted equipment.
2. Telecommunications ductbanks routed with electrical distribution system ductbanks shall be constructed in accordance with this Section.

B. Subsurface Utility Engineering

1. Subsurface Utility Engineering (SUE) is a necessary component of ductbank design. Design shall be based on SUE quality level B utility information as a minimum.
2. Civil engineering support is necessary for the successful completion of ductbank design.
3. SUE and ductbank design shall be performed in the project design phase and shall not be left to the contractor.
4. Prior to construction, vacuum excavation or hand excavation of existing utility crossings is recommended so that any conflicts are discovered in advance of ductbank construction. Vacuum excavation may be performed in the design or construction phases.

C. Design:

1. Ductbanks:

Include the following:

- a. Medium voltage electric ductbanks sloped for positive drainage to manholes and vaults. Low points that will hold water are not permitted. Minimum slope: 4" per 100'.
- b. Medium voltage electrical ductbanks should be configured two conduits wide.
 1. Exception: 3-conduit ductbanks may be arranged horizontally.
- c. Ductbanks shall be concrete encased. Provide longitudinal reinforcement at each corner as a minimum. Additional reinforcement shall be provided as determined by the Engineer.
- d. Conduits:
 1. 6" diameter for medium voltage electric
 2. 4" and 2" as required for telecommunications.

- e. At least one spare conduit for each system in all ductbanks. Spare ducts shall have printed pull tape and blank compression plugs installed.
 - f. Use only manufactured bends. Field bends are not acceptable.
 - g. Bend radius for conduits 4” and larger: 150” (12’-6”).
 - 1. Exception: Vertical bends at padmounted equipment or poles: 36” radius.
 - h. Add ductbank stubs where needed in order to support the campus master plan.
2. Manholes:
- Include the following:
- a. Precast concrete structures
 - b. Physical location selected to avoid heavy traffic areas, parking spaces, and to minimize flooding risk.
 - c. Equipped with 12” cast iron drain grates and opening through the bottom of the manhole. Blind sumps are not acceptable for general use.
 - d. Drains located directly below the access opening in the manhole top slab.
 - e. French drains below the drain opening in the floor. French drains contain at least $\frac{1}{2}$ yd³ in a hole lined with filter fabric. French drain located directly below the drain opening in manhole floor.
 - 1. Where the water table is known to be near the manhole floor level: Manhole fully waterproofed and equipped with sump pump or piped drain with backwater valve.
 - 2. Where the water table is known to be near the manhole floor elevation and sump pumps or piped drains are not possible: Manhole fully waterproofed and with closed sump.
 - f. Equipped with hot-dip galvanized cable racking channels, cable arms and porcelain insulator blocks.
 - g. Ductbanks entrance through duct terminators install by the precaster, or via core drilled holes or knockouts.
 - h. Where duct terminators are not used, end bells shall be installed on conduits and shall be set flush with the interior wall.
 - i. Pulling irons at the floor opposite each ductbank entrance area shown on the standard detail. Additional pulling irons provided as needed.
3. Vaults:
- a. General:
 - 1. Precast or cast-in-place concrete structures.
 - 2. Removable tops or hatches to facilitate equipment installation and replacement.
 - 3. Site selection to ensure crane access, avoid pedestrian and vehicular traffic areas, and minimize flooding risk.

b. Transformer Vaults

Include the following

1. Designed for personnel entry with code compliant access, headroom and working space.
2. Ventilation openings in top slab to meet NEC requirements.
3. Solid, lift-out hatches above transformers. Hatches sized to allow direct vertical lifting of transformers for installation and replacement.
4. Personnel access hatch, minimum of two per vault.
5. Personnel access hatches have padlock pockets.
6. Permanent ladder with pull-up extension or safety post below each personnel access hatch.
7. Where switches are installed in transformer vaults:
 - a. Switch operating hubs and contact viewing windows shall be no more than 12” below the top surface vault.
 - b. Manufactured access door with lift assist, padlock pocket and drainage.
 - c. Doors located directly above each switch.
 - d. Doors sized to allow full access to operating hubs and viewing windows and without obstructing operating handle travel.
8. Sump pump with automatic control and piped discharge.
9. Racking to support primary and secondary cables. Racking materials as specified for manholes above.

A typical network transformer vault shown is below. Other configurations with similar features are acceptable.

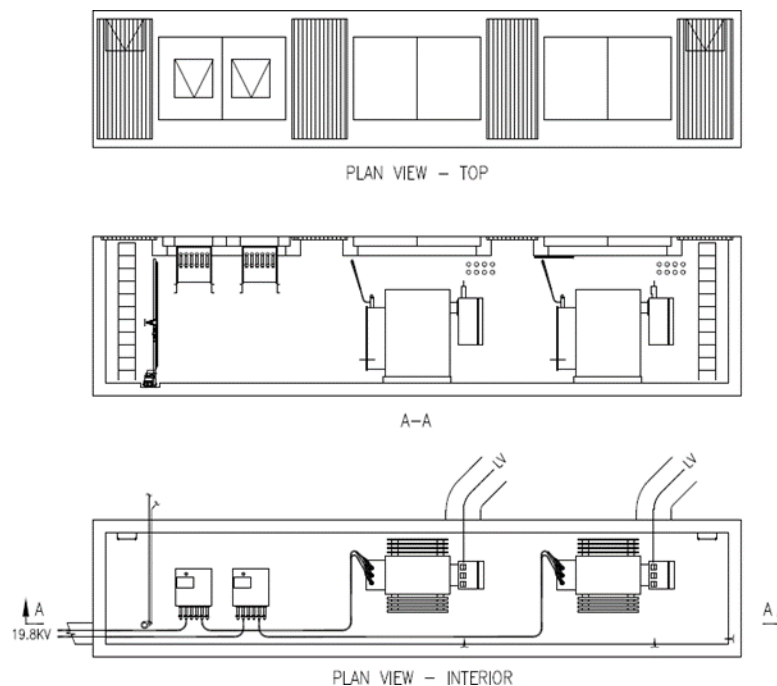

c. Switch vaults

Include the following

1. Drains equal to that specified for manholes above.
2. Removable top slab.
3. Switches and cable area working space accessible through manufactured access doors with lift assist and padlock pockets.
 - a. Switch operating hubs and contact viewing windows shall be no more than 12" below the top surface vault.
 - b. Manufactured access door with lift assist, padlock pocket and drainage.
 - c. Doors located directly above each switch.
 - d. Doors sized to allow full access to operating hubs and viewing windows and without obstructing operating handle travel.
 - e. Doors over cable area sized to allow full access to working space and compliance with NEC.
4. Racking to support primary cables. Racking materials as specified for manholes above.

A typical switch vault is shown below. Loop switch shown. Fault interrupter switches similar.

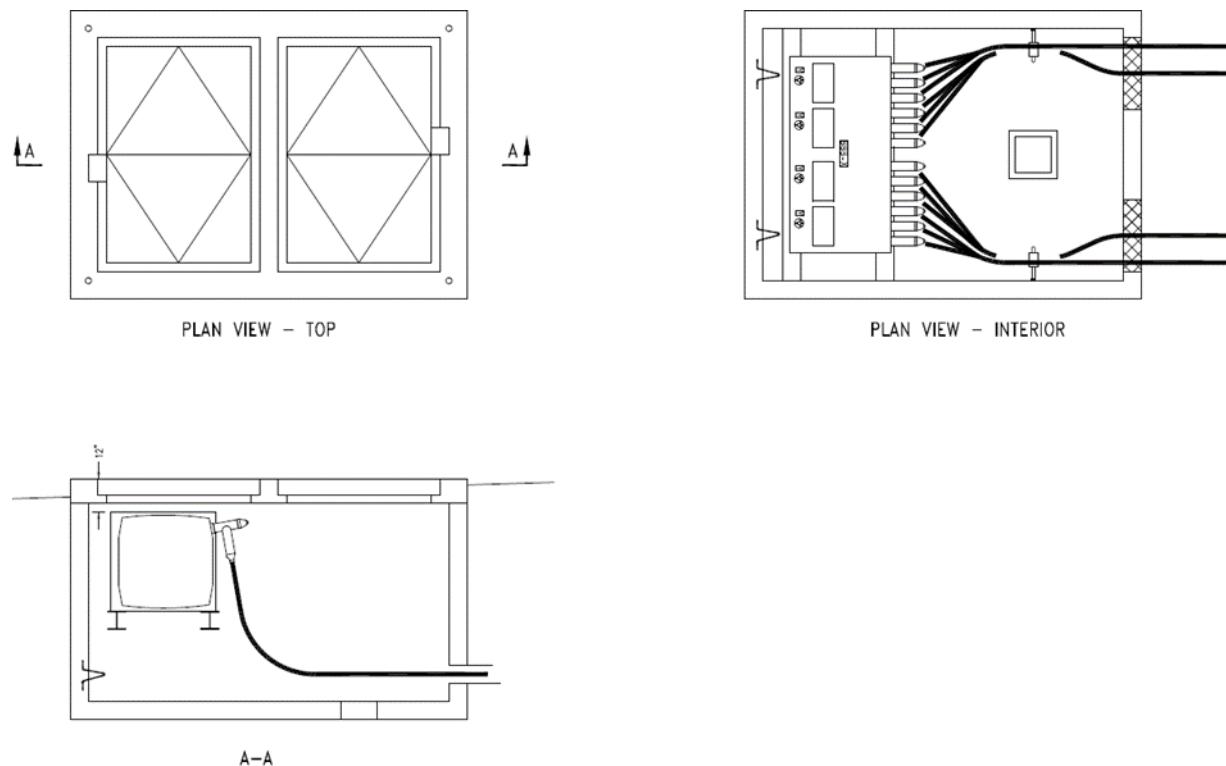

D. Construction Documents:

1. Ductbanks:

- a. Ductbanks shall be shown in plan and profile. Draw ductbank width and bend radii to scale. Show relative positions of other new and existing utilities and obstructions in plan and profile.
- b. Ductbanks shall be shown entering manholes and vaults perpendicular to manhole and vault walls and within designated ductbank entrance areas. Coordinate with manhole and vault orientation.
- c. Show conduit arrangement and spacing.
- d. Conduit types and manufactured bends shall be clearly specified.

2. Manholes:

- a. Show manholes to scale in plan view. Do not use generic symbols to represent manholes.
- b. Georgia Tech standard details shall appear in the construction drawings or the elements of those details shall be incorporated into similar details. Georgia Tech standard details are shown at reduced scale for informational purposes at the end of this Section and are available in AutoCAD on request.

3. Vaults:

- a. Show transformer and switch vaults to scale in plan and section.
- b. Show the arrangement of cables and equipment in each vault.
- c. Include dimensions for critical items such as distance from top of vault to the top of switches, and electrical workspaces.

2.01 Products

A. Ductbanks:

1. Conduits for use in ductbanks shall be:

- a. 4" and larger: PVC type DB-60 with manufactured bends.
 1. Vertical bends at padmounted equipment or poles shall be PVC schedule 40 or PVC schedule 80.
- b. Smaller than 4": PVC schedule 40 with manufactured bends.

2. Spacers shall be plastic, manufactured for the conduit types being installed.

3. Pull tape shall be 1250 lb tensile strength, marked in feet.

4. Plugs for spare ducts shall be blank mechanical compression type, Jackmoon or equal.

B. Manholes:

1. Manholes shall be precast concrete. The manufacturer shall be regularly engaged in the business of manufacturing precast manholes or other precast concrete utility products.
 - a. 4-Way manholes (preferred): 4-way type having four 2'-10" wide duct entrance walls and four 6' wide splice walls creating a roughly octagonal structure. Wall widths are inside dimensions. The interior height shall be at least 7'. Ductbanks shall enter only in duct entrance walls (the 2'-10" wide walls).
 - b. Rectangular manholes (alternate): Inside dimensions of 6' x 12' or 6' x 16' with 7' interior ceiling height. Allowable ductbank entrance areas are centered horizontally in the end walls (the 6' wide walls) and within 30" horizontally of each end of the side walls (the 12' or 16' walls).
2. Riser sections shall be precast concrete except that a minimal amount of brick and mortar may be used as needed to align the ring with grade.
3. Drain grates shall be cast iron with cast iron frame. Grates shall be removable.
4. Manhole racking shall be hot dip galvanized. Racks shall consist of wall mounted channels with removable galvanized cable arms. Cable arms shall be provided with porcelain insulating blocks.
5. Rings and covers shall be cast iron with 36" nominal opening diameter. Cover logo shall be "ELECTRIC" for electric manholes and "COMMUNICATIONS" for telecommunications manholes.
6. Steps and hook ladders shall be utility products designed for manhole applications. Non- conductive materials are preferred. Steps and ladders shall be OSHA compliant.

C. Vaults:

1. Where precast products are used they shall be the products of a manufacturer regularly engaged in the business of fabricating precast concrete utility products.
2. Access ladders shall be fixed, with pull up extensions or pull-up safety posts designed for manhole and vault applications. Non-conductive materials are preferred. Ladders shall be OSHA compliant.
3. Access doors shall be manufactured products complete with lift assist device, flush padlock pocket and drain channel with drain outlet. Furnish Bilco or equal.
 - a. Exception: Personnel access hatches located within gratings in transformer vault tops are permitted to be shop-fabricated hinged grating panels with flush padlock pockets.
4. Racking shall be hot dip galvanized. Racks shall consist of wall mounted channels with removable galvanized cable arms. Cable arms shall be provided with porcelain insulating blocks.
5. Sump pumps shall be cast-iron, hermetically sealed designed for effluent and dewatering applications, capable of passing at least ½" diameter spherical solids. Pumps shall not have screens. Pumps shall be equipped with automatic float control switches and discharge check valves.

3.01 Execution

A. Ductbanks:

1. Ductbanks shall enter manhole and vault walls horizontally and perpendicular to the manhole or vault wall. Ductbanks shall not enter manhole or vault ceilings or floors. Ductbanks shall not enter manhole riser sections. Ductbank entrances shall be at least 1' above manhole or vault floors.
2. Trenches for ductbanks shall be excavated with trimmed sides and minimum excess width.
3. Conduits shall be secured to manufactured spacers and shall be tied to prevent floating.
4. Where trenches are more than 12' wider than the minimum ductbank width, forms shall be used to control ductbank width.
5. Concrete shall be carefully placed and shall be consolidated with immersion vibrators to ensure complete encasement.
6. Do not place excess concrete on or around ductbanks. Encasement thickness on all sides shall meet the specified minimum requirement, but shall not significantly exceed the minimum requirement.
7. Do not allow encasement to surround or adhere to adjacent utilities. Use forms, sleeves, bond breakers or other suitable means to keep ductbank encasement separate from other utilities.
8. Install warning tape above all ductbanks.
9. Install insulated locator wire in all telecommunications ductbanks.
10. Install printed 1250 lb pull tape in all spare conduits. Tape shall be marked in feet.
11. Install blank compression plugs in spare conduits.
12. Document ductbank stubs on as-built drawings, install locator wires in the encasement and mark the capped ends of stubs with metallic markers composed of not less than 3' of 2" RGS conduit each buried vertically at the end of each stub. Leave 1' of exposed conduit and rebar at ends of stubs. Wrap buried stubs in 20 mil polyethylene.

B. Manholes and vaults:

1. Set manholes and vaults plumb and level.
2. Install sealant between all precast components.
3. Adjacent manholes shall be placed such that ductbanks may enter through all four ductbank entrance walls in each manhole without interference from adjacent manholes or other ductbanks.
4. Cables shall be placed on porcelain insulating blocks and lashed in places with non-metallic wire ties.
5. Manhole and switch vault drains: French drains shall be lined with filter fabric. Stone shall be #57 stone or other suitable stone that does not contain fines. Do not use crusher run. Keep filter fabric clean.

6. French drains in manholes contaminated with mud during construction shall be cleaned out and new filter fabric and stone shall be installed.
 7. Transformer vaults shall include depressed sumps with sump pumps. Sump depth and float switch position shall be arranged such that water is pumped out until the water level falls below the vault floor level.
 8. Ductbanks shall enter through terminators precast into the manhole wall where present. Where conduits enter without duct terminators, end bells shall be installed and shall be set flush with the interior wall. Conduits and end bells shall be grouted in place.
 9. Telecommunications conduits shall not enter electric manholes or vaults. Electric conduits shall not enter telecommunications manholes.
- C. General:
1. The contractor shall pump and clean new and existing manholes and vaults as needed to accomplish the work and as needed to allow inspection.

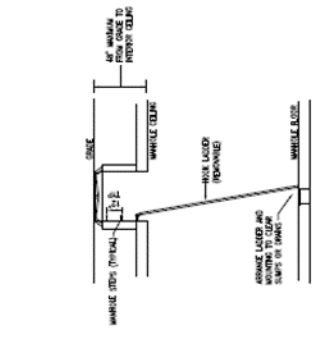

STANDARD RISER
 FINISH STEPS AND RAIL-GUARDS WERE DISTANCE FROM FINISH GRADE TO MANHOLE COVER IS 12" OR MORE

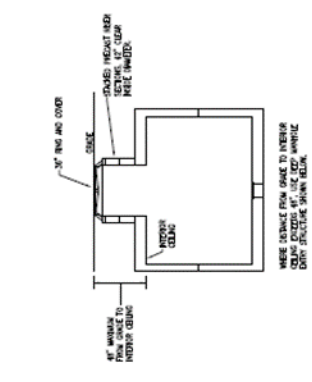

RECTANGULAR MANHOLE
 FINISH STEPS AND RAIL-GUARDS WERE DISTANCE FROM FINISH GRADE TO MANHOLE COVER IS 12" OR MORE

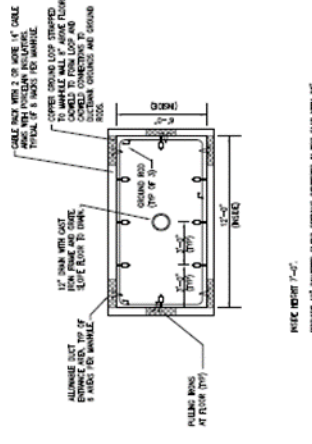

4-WAY MANHOLE
 FINISH STEPS AND RAIL-GUARDS WERE DISTANCE FROM FINISH GRADE TO MANHOLE COVER IS 12" OR MORE

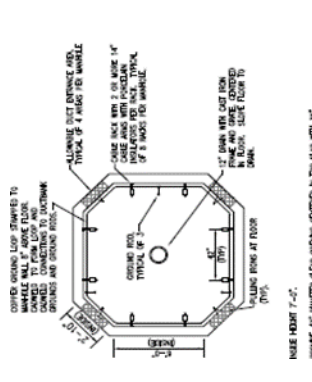

DEEP MANHOLE ENTRY STRUCTURE
 FINISH STEPS AND RAIL-GUARDS WERE DISTANCE FROM FINISH GRADE TO MANHOLE COVER IS 12" OR MORE



CABLE RACKING
 FINISH STEPS AND RAIL-GUARDS WERE DISTANCE FROM FINISH GRADE TO MANHOLE COVER IS 12" OR MORE

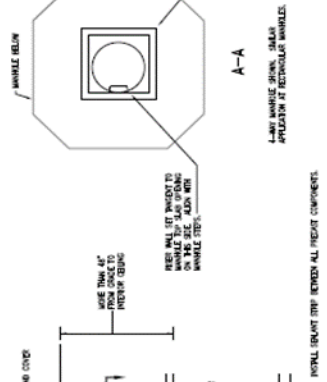

STANDARD RISER
 FINISH STEPS AND RAIL-GUARDS WERE DISTANCE FROM FINISH GRADE TO MANHOLE COVER IS 12" OR MORE

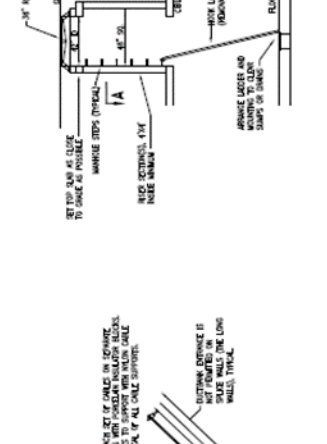

RECTANGULAR MANHOLE
 FINISH STEPS AND RAIL-GUARDS WERE DISTANCE FROM FINISH GRADE TO MANHOLE COVER IS 12" OR MORE

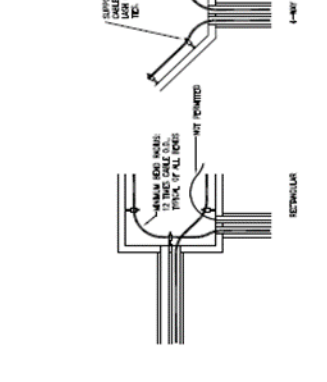

4-WAY MANHOLE
 FINISH STEPS AND RAIL-GUARDS WERE DISTANCE FROM FINISH GRADE TO MANHOLE COVER IS 12" OR MORE



DEEP MANHOLE ENTRY STRUCTURE
 FINISH STEPS AND RAIL-GUARDS WERE DISTANCE FROM FINISH GRADE TO MANHOLE COVER IS 12" OR MORE

END OF SECTION

SECTION 260553 – IDENTIFICATION

1.01 GENERAL

- A. Scope: Identification for low and medium voltage electrical power system components.
- B. Building Power System Identification
 - 1. Engraved plastic laminate nameplates shall be installed for identification of:
 - a. Circuit breakers in switchgear, switchboards and distribution panelboards
 - b. Fusible branch devices in switchboards and distribution panelboards
 - c. Motor controllers, circuit breakers and fusible switches in motor control centers
 - d. Individual motor controllers
 - e. Lighting contactors and lighting control panels
 - f. Panelboards
 - g. Switchboards
 - h. Switchgear
 - i. Transformers
 - j. Enclosed circuit breakers and switches.
 - k. Transfer switches
 - 2. Self-adhesive machine-printed labels shall be installed on receptacle cover plates for the identification of receptacle branch circuits.
 - 3. Directory cards shall be provided for identification of branch circuit breakers in branch circuit panelboards.
 - 4. In the Holland and 10th St Plants, power conduits shall be painted orange and shall have the circuit voltage labeled on each power conduit at 10' intervals. Voltage labels shall be 1" black lettering on an orange background.
- C. Medium Voltage Distribution System Identification
 - 1. Laser marked stainless steel tags shall be installed for identification of medium voltage cables in below-grade locations such as in manholes and vaults.
 - 2. Write-on Plastic Cable Tags shall be installed for identification of medium voltage cables in above-grade outdoor locations and at indoor locations.
 - 3. Self-Adhesive Reflective Labels shall be installed for identification of medium voltage switches and transformers.
 - 4. Painted, Stenciled Lettering shall be applied to manhole interior walls.
- D. Colored Tape shall be used for phase identification in low and medium voltage systems except that continuously colored insulation is permitted for phase identification in low voltage systems.

- E. A medium-voltage cable tag schedule and GT-standard cable tag details will be provided by Facilities Design and Construction for inclusion in the plans. Alternatively, the Facilities D&C-provided cable tag schedule may be included by reference. The schedule will be keyed to the project medium- voltage 1-line diagram. An example is included at the end of this Section.
- F. For projects involving no more than three medium voltage switches and/or no more than six medium- voltage transformers, the Owner will furnish and install labels for switches and transformers. The contractor shall coordinate time and access for application of labels.

2.01 PRODUCTS

- A. Medium Voltage Identification Materials:
 - 1. Subsurface cable tags: 3" square, type 304 stainless steel, 18 ga minimum with ¼" black laser-marked lettering and top hole for attachment with cable ties.
 - 2. Above grade cable tags: Electromark URD-PC white plastic write-on tag with holes for attachment with cable ties. Lettering shall be legibly handwritten in black indelible marker.
 - 3. Ties for attachment of subsurface and above ground cable tags: UV-stabilized nylon cable ties.
 - 4. Self-adhesive, reflective labels: Self-adhesive sunlight-resistant reflective mylar weatherproof labels with 2 ½" lettering, Electromark REFL-YK-2.5 or equal. Yellow lettering on black background.
 - 5. Paint and stencils for stenciled lettering: Industrial enamel paint. Manufactured block-letter stencils, 6" letter height for manhole identification.

3.01 EXECUTION

- A. All medium voltage equipment and cable shall be labeled and tagged prior to energization.
- B. Medium Voltage Cable Tags
 - 1. Lettering shall be in accordance with the approved cable tag schedule
 - 2. Install at least two tags on each cable in each manhole and vault.
 - 3. Where cables are spliced, install at least one tag on each side of each splice (a minimum of two tags for a straight splice, three tags for a three-way splice, etc.).
 - 4. Install cable tags at each cable termination.
 - 5. Attach cable tags to cables using UV-resistant non-metallic cable ties.
 - 6. Where fire and arc-proofing tape is present, attached cable tags over fire and arc-proofing tape.
 - 7. At cable terminations, attach tags to center phase cable.
- C. Medium Voltage Switch and Transformer Identification
 - 1. Identification is Owner-installed on smaller projects as noted above. 2.
 - 2. Individual letter and number labels shall be applied along a level horizontal line with no gaps between adjacent letters and numbers.

3. Label placement shall be applied as shown at the end of this Section (larger scale copy available on request).
 4. Transformer number format: BBBVN
 - “BBB” is the associated campus building number
 - “V” is a voltage code. L=208V or 240V, H=480V, S=medium-voltage secondary
 - “N” is a sequence number

Do not add spaces, dashes or other characters.
 5. Switch number format: BBB-X-Y
 - “BBB” is the associated campus building number
 - “X” is a sequence number
 - “Y” is the compartment or way number.

Do not add spaces or other characters
- D. Manhole Identification
1. Label each duct entrance face in electric manholes. Label each wall in rectangular manholes.
 2. Labels shall consist of the manhole number plus “N”, “E”, “S”, “W”, “NE”, “SE”, “SW”, or “NW” to indicate the approximate direction of each labeled wall.
 3. Labels shall be neatly stenciled lettering in red enamel on a clean portion of the interior wall and shall be located approximately 5’ above the manhole floor. Where in conflict with ductbank entrances, labels shall be placed above or below ductbanks, as close as possible to the preferred 5’ height.
 4. Manhole numbers shall be as shown on the plans and shall not include only numbers. Do not include E or EMH, etc. in manhole wall identification.
- E. Phase identification tape shall be applied near each splice and termination.
1. Where fire and arc-proofing tape is present, phase identification tape shall be applied over fire and arc-proofing tapes.

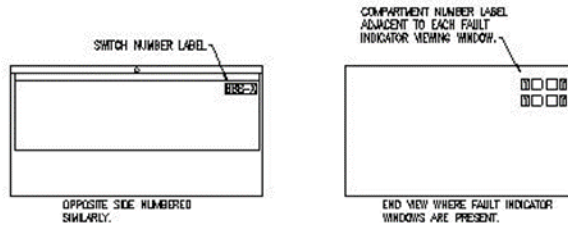

TYPICAL PADMOUNTED SWITCH

THIS DETAIL SHOWS ONLY THE OUTER ENCLOSURE LABELING. LABELS ARE ALSO REQUIRED ON THE SWITCH TANK. APPLY LABELS ON TANK SURFACE IN ACCORDANCE WITH THE DETAIL PROVIDED FOR SUBSURFACE AND VAULT STYLE SWITCHES.

ILLUSTRATION BASED ON S&C VISTA. OTHER TYPES SHALL BE NUMBERED SIMILARLY.

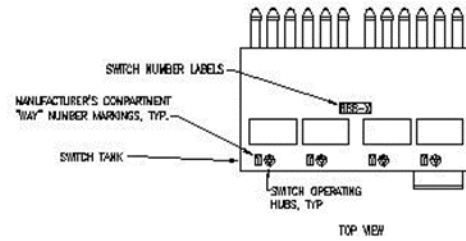

TYPICAL VAULT-STYLE AND SUBSURFACE SWITCH NUMBERING.

APPLY NUMBERS TO TANK SURFACE. DO NOT APPLY NUMBERS OVER NAMEPLATES, LABELS OR VIEWING WINDOWS.

FOR ALL 5 AND 6 WAY SWITCHES, AND FOR OTHER TYPES WHEN INSTALLED BELOW MULTIPLE ACCESS DOORS, INSTALL ONE SET OF SWITCH NUMBER LABELS ON EACH AREA OF THE SWITCH TANK VISIBLE UNDER EACH DOOR.

ILLUSTRATION BASED ON S&C VISTA. OTHER TYPES SHALL BE NUMBERED SIMILARLY.

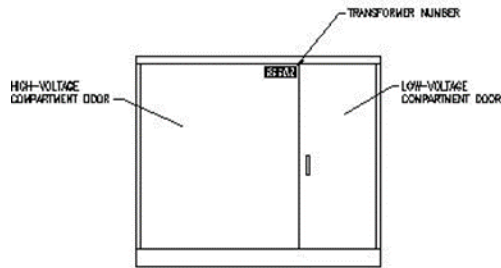

TYPICAL PADMOUNTED TRANSFORMER

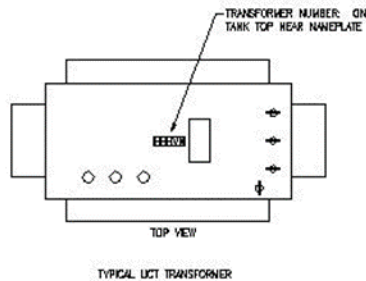
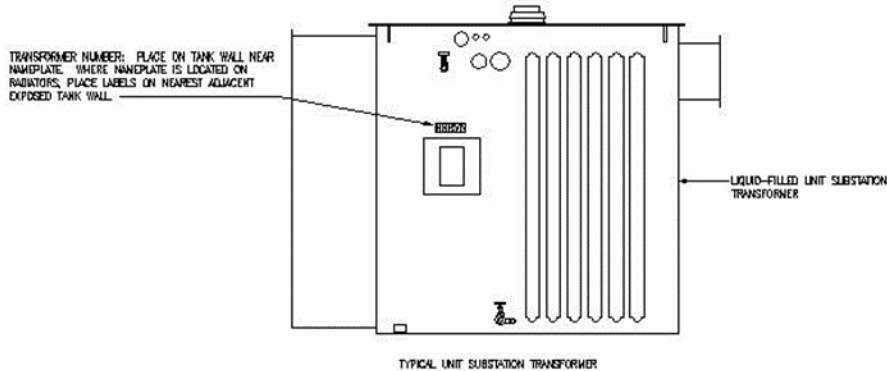
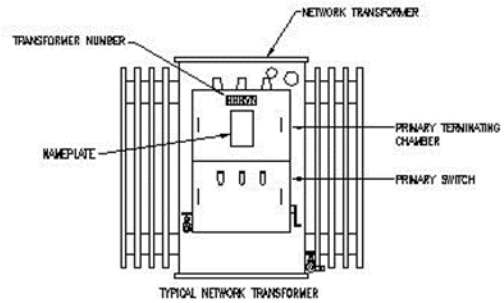

MEDIUM VOLTAGE EQUIPMENT IDENTIFICATION LABEL PLACEMENT

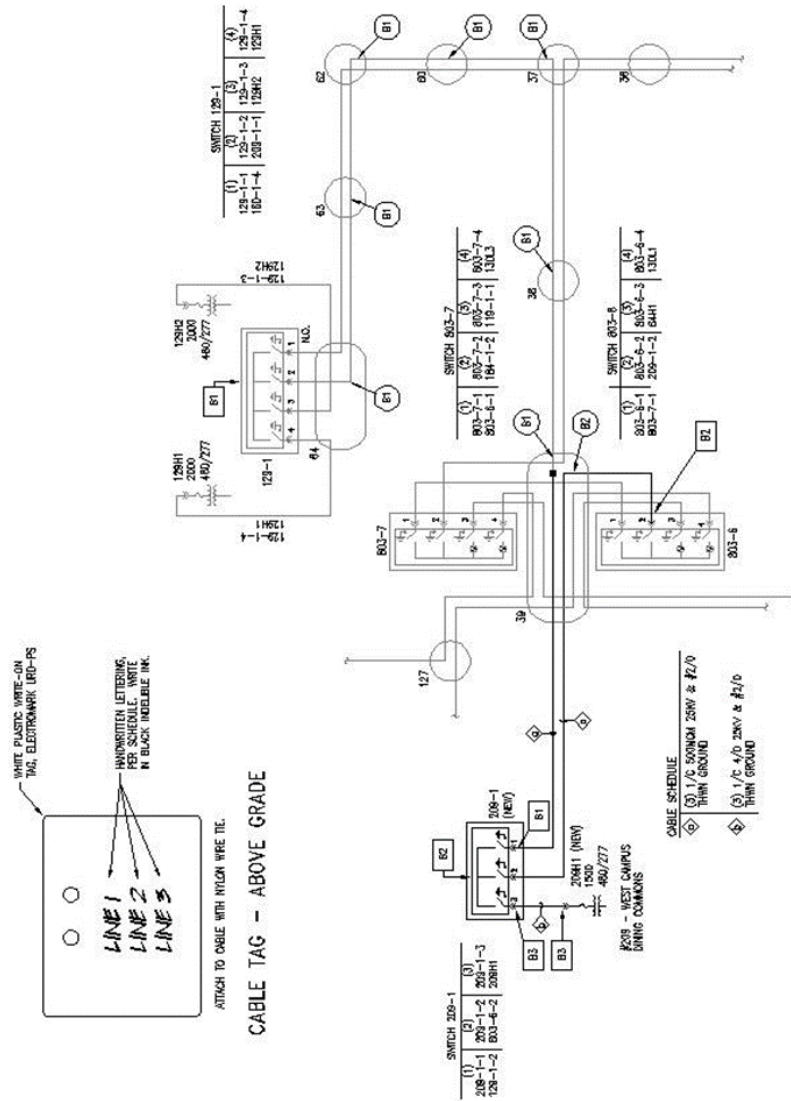

PARTIAL LOOP B 1-LINE DIAGRAM-
NEW WORK

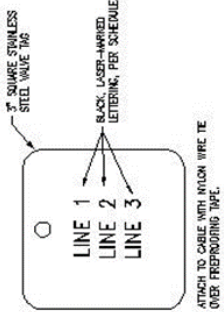

CABLE TAG - BELOW GRADE

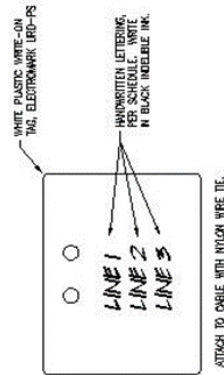

CABLE TAG - ABOVE GRADE

CABLE TAG SCHEDULE

KEY	TAG TYPE	TAG TEXT	NOTES
B1	PLASTIC	LINE 1: 200V LOOP B LINE 2: 200-1-2 LINE 3: 200-1-1	
B1	SQUARE, STAINLESS STEEL	LINE 1: 200V LOOP B LINE 2: 128-1-2 LINE 3: 200-1-1	
B2	PLASTIC	LINE 1: 200V LOOP B LINE 2: 200-1-2 LINE 3: 803-6-2	
B2	SQUARE, STAINLESS STEEL	LINE 1: 200V LOOP B LINE 2: 200-1-2 LINE 3: 803-6-2	
B3	PLASTIC	LINE 1: 200V LINE 2: 200-1-3 LINE 3: 200H1	

END OF SECTION

INSTALL A MINIMUM OF TWO NEW TAGS ON EACH INDICATED CABLE IN EACH MARSHAL. AT SPLICES, INSTALL A CABLE TAG ON EACH SIDE OF EACH SPLICE.
AT PACKAGED EQUIPMENT, INSTALL CABLE TAG ON CENTER PHASE.
INSTALL PHASE MARKING TAPE BROWN, ORANGE, YELLOW, MATCH EXISTING PHASE MARKING. INSTALL ON TOP OF AIR-PROTECTING TAPE.
REMOVE EXISTING TAGS (WHERE PRESENT) AFTER INSTALLATION OF NEW TAGS AND INSPECTION BY THE OWNER.

SAMPLE

SECTION 260573 – POWER SYSTEM STUDIES

1.01 General

A. Power System Studies:

1. Short-circuit, coordination, and arc-flash studies shall be completed by a licensed engineer as a required element of each construction or renovation project. Studies shall include all low- voltage and medium-voltage equipment affected by the project.
 - a. Harmonic studies shall be performed for projects with a high concentration of non- linear loads and for any project in which harmonic filters are proposed.
 1. Harmonic studies shall be based on actual power system data, shall be performed by a qualified engineer and in compliance with IEEE 399. Simplified harmonic calculator software and spreadsheets are not acceptable.
2. Studies shall be based on actual electrical system component characteristics and conductor lengths.
3. Short circuit studies shall include evaluation of interrupting ratings and withstand ratings.
4. Coordination studies shall be performed wherever adjustable trip devices and/or fusible equipment is used.
5. An arc-flash hazard study shall be performed and detailed labels shall be applied to equipment including but not limited to the following. All arc-flash hazard warning labels shall include actual calculated arc-flash hazard data. General warning labels are not acceptable.
 - a. Medium-voltage switches
 - b. Medium voltage transformers
 - c. Network protectors
 - d. Switchgear
 - e. Switchboards
 - f. Panelboards
 - g. Motor controllers
 - h. Enclosed circuit breakers
 - i. Safety switches
 - j. Other equipment in accordance with the NEC and NFPA 70E.

- B. Studies shall comply with IEEE 399 and IEEE 1584.

- C. For projects served by the campus electrical distribution system, fault current at the point of connection for the project and upstream OCPD data will be furnished by Facilities Design and Construction upon request. Note - The campus 19.8kV switching station includes a high speed current limiter that will act to limit 19.8kV fault currents. That limiter is not sensitive to secondary faults. This condition shall be taken into consideration in the preparation of short circuit, coordination and arc-flash hazard studies.

2.01 Products

- A. Studies shall use computer programs that are distributed nationally and are in wide use. Manual calculations are not acceptable.
- B. Analytical features of short-circuit study computer software program shall include "mandatory," "very desirable," and "desirable" features as listed in IEEE 399.
- C. Computer software program shall be capable of plotting and diagramming time-current-characteristic curves as part of its output. Computer software program shall report device settings and ratings of all protective devices.
- D. Arc-flash risk labels shall comply with NFPA 70E and shall contain at least the following:
 - 1. System voltage
 - 2. Arc-flash boundary
 - 3. Incident energy and working distance, or PPE category
 - 4. Minimum arc rating of clothing
 - 5. Bus or equipment name
 - 6. Upstream overcurrent protective device name
- E. Arc-flash hazard risk labels at locations in which no safe PPE exists shall have a red background.

3.01 Execution

- A. Provide a copy of the short circuit, coordination and arc-flash studies for review by the office of Facilities Design and Construction.

END OF SECTION

SECTION 260923 – LIGHTING CONTROLS

1.01 GENERAL

- A. Scope: Lighting controls for indoor and outdoor applications except for the following:
 - 1. Parking garage lighting controls – see section 265600.
- B. Application:
 - 1. Automatic lighting controls shall be installed in all areas except where prohibited by code or where application of automatic control would create a safety hazard. Select automatic control methods as appropriate for each space and the intended use.
 - a. Indoor lighting control should utilize occupancy or vacancy sensors wherever suitable.
 - b. Outdoor lighting should utilize photo controls. Where photo control is impractical, astronomic timeclock control is acceptable.
 - c. Utility closets and similar spaces may utilize digital timeout switches in lieu of occupancy or vacancy sensors.
 - d. Retail space, reception areas and similar spaces where it is necessary for lights to be on continuously in business hours should utilize automatic time-based controls.
- C. General:
 - 1. Avoid unnecessarily complex lighting control systems. Simple controls that can be easily adjusted or replaced by maintenance personnel are preferred.
 - 2. Street and walkway lighting should have group control via standard lighting contactors. For small areas, individual photo control is acceptable.

2.01 PRODUCTS

- A. Occupancy and Vacancy sensors:
 - 1. Occupancy and vacancy sensors shall be tested in accordance with NEMA WD 7. Major and minor motion coverage diagrams developed in accordance with NEMA WD 7 shall be included in the manufacturer's published data.
 - 2. Preferred sensor types:
 - a. Enclosed spaces – ultrasonic
 - b. Open spaces – combination ultrasonic and PIR
 - c. Corridors and other general circulation spaces - ultrasonic
 - d. Restrooms - ultrasonic
 - e. Outdoor areas – PIR
 - 3. Provide means accessible to occupants for manual override to 'off' state.
- B. Digital timeout switches:
 - 1. Tamper-proof electronic timer switches similar to WattStopper TS-400.
 - 2. Time delay shall be set by means of dip switches or similar method, concealed when cover plates are installed.

3. Mechanical timers are not acceptable.
- C. Time-based controls shall include means for temporary manual override by the occupants.
- D. Daylighting controls for interior spaces should utilize dimming. On-off control and stepped control should be avoided in interior spaces.
- E. Lighting contactors shall be multi-pole NEMA contactors in enclosures and shall be equipped with an LED status light and hand/off/automatic control.

3.01 EXECUTION

- A. Select and place occupancy and vacancy sensors in individual offices, open office spaces, classrooms, conference rooms and similar spaces such that the sensors will detect minor motion at each occupant workstation. Minor motion shall be as defined in NEMA WD 7.
- B. Select and place occupancy sensors in corridors and other general circulation spaces such that sensors will detect major motion throughout the space. Major motion shall be as defined in NEMA WD 7.
- C. Review sensor placement and adjustment during construction in order ensure that coverage meets the intent stated above. Provide additional sensors and/or relocate sensors as needed to achieve the intended coverage.

END OF SECTION

SECTION 261000 – CAMPUS MEDIUM VOLTAGE ELECTRICAL DISTRIBUTION

1.01 General

A. Application:

1. This section addresses expansion, modification and improvements of the Georgia Tech medium voltage electrical distribution system.
2. Construction projects shall include underground primary extensions as needed and in accordance with campus standards. Extensions shall be constructed to support future construction and development in accordance with the campus master plan.

B. General Information:

1. The main campus receives 19.8kV 3-phase, grounded wye service via the Georgia Tech switching station and a co-located Georgia Power Company (GPC) 230kV-19.8kV substation. The Georgia Tech switching station receives power on two main busses and includes automated transfer and bus restoration functions. High speed fault current limiters are used to manage fault current levels on campus feeders. The substation is equipped with a SCADA system. Additional information will be provided on request.
2. The main campus medium-voltage distribution system is owned and operated by Georgia Tech. It is not affiliated with any public utility. As such, the cost of extensions and modifications are direct project costs.
 - a. Campus buildings and facilities receive electrical service from the campus distribution system under two separate classifications of service reliability.
 1. Critical facilities are supplied through secondary spot networks, while general and support facilities are served by a primary loop system. The 19.8kV feeders for spot network systems are completely separate from the 19.8kV feeders used in primary loop systems. These schemes and their application are discussed in greater detail in other articles in this Section.
 - b. The two central utility plants are provided with redundant 19.8kV feeders and primary selective switchgear.
3. The Holland electric boiler is served by a 13.2kV spot network via campus feeders and a dedicated GPC delivery point.
4. The Tech Square complex is served directly by GPC.
5. The Cobb County research facility has a Georgia Tech owned underground 4.16kV distribution system served from an on-site GPC substation.
6. Other remote facilities as well as some peripheral main campus buildings are served directly by GPC.

C. Definitions:

1. **Critical Applications:** Those applications in which an electrical failure would disrupt the operation of laboratories, cleanrooms, telecommunications head-end, CATV backbone, network backbone, voice over IP, campus computing resources, or utilities for such spaces or other essential areas or processes.

2. Distribution system: The campus medium voltage electrical distribution system including all voltage levels 4.16kV and above. In-building medium-voltage circuits serving utilization equipment such as medium-voltage motors or boilers are not considered to be a part of the distribution system.
3. Feeder: A medium voltage cable extending from the switching station (aka substation) feeder breaker to the first loop switch or to the line side of fault interrupter or primary selective switches.
 - a. Loop feeder: A feeder serving one or more primary loops.
 - b. Network feeder: A feeder serving secondary spot networks
4. Lateral: The cable between a loop switch or primary selective switch and a transformer or between a fault interrupter switch and a network transformer.
5. Loop Cable: A cable between two loop switches.
6. Switch: A loop switch, fault interrupter switch or primary selective switch.
 - a. In switches that contain multiple switch compartments on a common bus, each switch compartment is referred to as a switched way. For example, a 4-compartment loop switch has four switched ways. Switched ways are identified by the switch manufacturer's factory installed numbering.

D. Electrical Distribution Design - General:

1. All new distribution system medium-voltage cables shall be installed in a system of concrete encased ductbanks and manholes. Aerial distribution, direct burial cable and direct burial conduit are not acceptable methods for installing medium voltage distribution circuits.
2. Feeder paths shall be formed by ductbanks and manholes. Feeders and loop cables shall enter switch and transformer vaults only where needed to connect to switches and shall not continue beyond the point of connection unless the feeder and/or loop cables enter and exit the pad or vault through a single manhole.
3. All additions or changes to the system must follow the distribution system master plan. Numbers of conduits in ductbanks, locations of manholes, routes of feeders and locations of equipment shall be as needed to support the campus master plan. All additions or changes shall be designed in consultation with the office of Facilities Design and Construction early in the development of each project.
4. Transformers shall be 3-phase with delta primary. Switches shall be 3-phase, gang operated.
5. All distribution system transformers 750kVA and above and all network transformers of any size shall have ANSI standard impedances. Do not specify non-standard impedances as a means to reduce interrupting rating requirements for downstream equipment.
6. Construction projects shall include underground primary extensions as needed and in accordance with campus standards. Extensions shall be constructed to support future construction and development in accordance with the campus master plan. Numbers of conduits in ductbanks, locations of manholes, routes of feeders and locations of equipment shall be as needed to support the campus master plan. All ductbanks, manholes, feeder cable and equipment to

support the project and in accordance with the above shall be provided as a part of the project. This requirement applies to on-site and off-site components. Facilities Design and Construction will designate the points of connection.

E. Distribution Schemes:

1. Primary Loop Distribution:

a. Related sections:

1. 260513 Medium Voltage Cable
2. 260526 Grounding and Bonding
3. 260543 Underground Ductbanks, Manholes and Vaults
4. 260553 Identification for Electrical Systems
5. 261219 Pad-mounted, Liquid-Filled Medium-Voltage Transformers
6. 261328 Medium-Voltage Loop Switches

b. Key design elements for primary loop distribution (see related sections for additional information):

1. Loop switches are manually-operated, load-break 3-position, grounding switches.
 - a. Switch ways 1 and 2 are always used for loop cables or for feeder and loop cables. Remaining ways 3 and higher are used for transformer laterals.
 - b. All load connected to a primary loop shall be connected through a loop switch. No direct connection of a transformer or other load to a loop cable is permitted.
 - c. Fault indicators are installed on each switched way.
2. No wye or other multi-way splices or connections are permitted on loop cables or laterals.
3. Transformers are pad-mounted, compartmental types with internal primary overcurrent protection.
 - a. Subsurface transformers may be considered where pad-mounted types cannot be accommodated.
4. Connect one transformer per switched lateral, one lateral per switched way.

c. Primary loop distribution scheme is illustrated on following page:

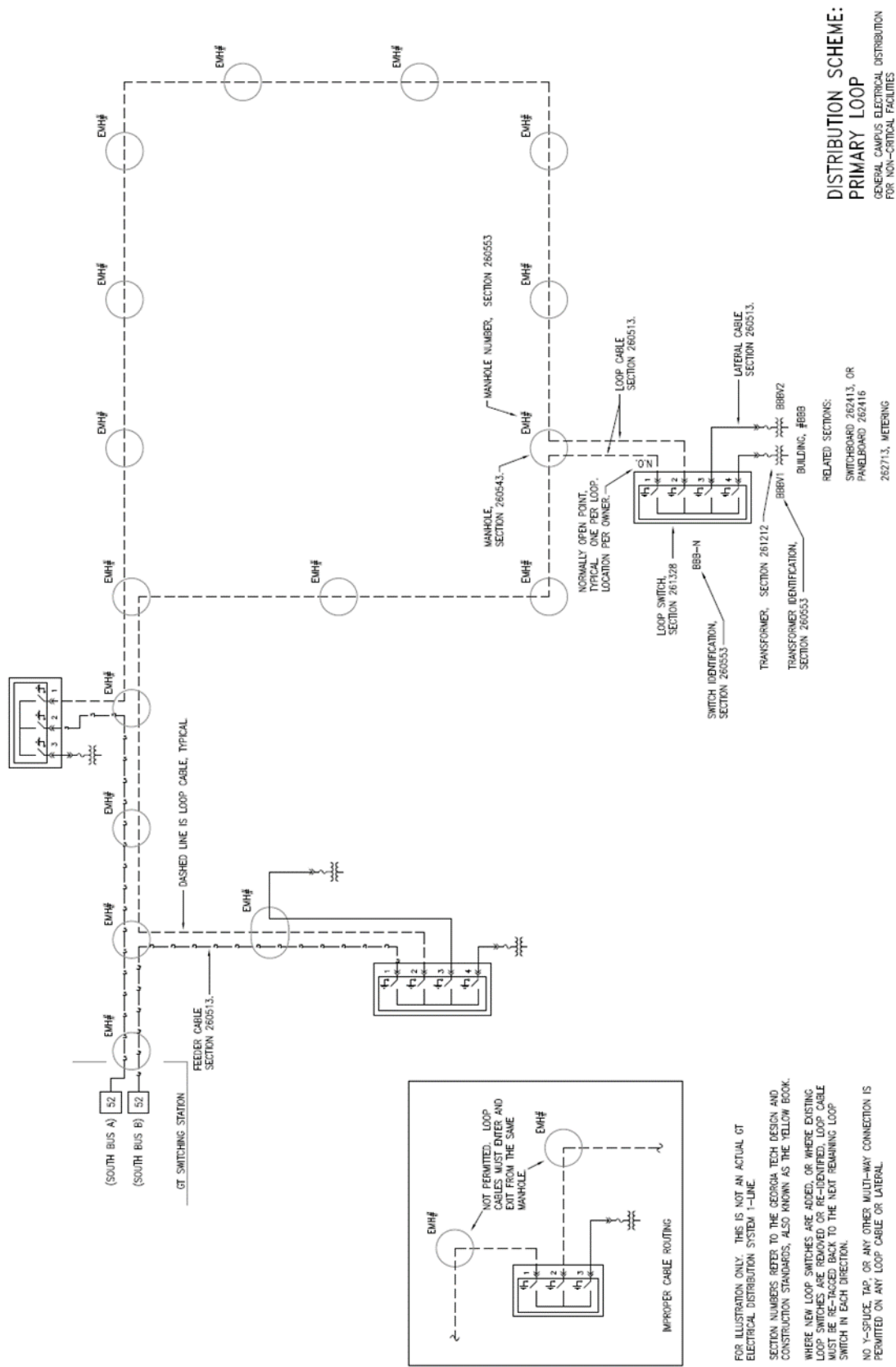

FOR ILLUSTRATION ONLY. THIS IS NOT AN ACTUAL GT ELECTRICAL DISTRIBUTION SYSTEM 1-LINE.

SECTION NUMBERS REFER TO THE GEORGIA TECH DESIGN AND CONSTRUCTION STANDARDS, ALSO KNOWN AS THE YELLOW BOOK.

WHERE NEW LOOP SWITCHES ARE ADDED, OR WHERE EXISTING LOOP SWITCHES ARE REMOVED OR RE-IDENTIFIED, LOOP CABLE MUST BE RE-TAGGED BACK TO THE NEXT REMAINING LOOP SWITCH IN EACH DIRECTION.

NO Y-SPLICE, TAP, OR ANY OTHER MULTI-WAY CONNECTION IS PERMITTED ON ANY LOOP CABLE OR LATERAL.

2. Spot network distribution:

a. Related sections

1. 260513 Medium Voltage Cable
2. 260526 Grounding and Bonding
3. 260543 Underground Ductbanks, Manholes and Vaults
4. 260553 Identification for Electrical Systems
5. 261212 Liquid-Filled Network Transformers
6. 261329 Medium-Voltage Fault Interrupter Switches
7. 262316 Low-Voltage Network Protectors
8. 262300 Low-Voltage Switchgear

b. Key design elements for spot network distribution (see related sections for additional information):

1. Network feeders are routed in pairs. Each feeder is completely independent of the other. Network feeders are radial and have no means of connection between the two feeders at primary voltage (see Existing Deficiencies article in this Section).
2. Network transformers are installed in pairs with fully redundant capacity. Transformers are sized such that in the event of a feeder outage, the transformers remaining in service are adequate to carry the full load of the building continuously.
3. Network transformers must be installed in secured vaults.
4. Fault interrupter switches are installed on feeder taps and provide overcurrent protection as well as switching capability for each network transformer.
5. Fault interrupter switches are 3-position grounding, manually operated and with electronically controlled fault interrupters.
6. Fault interrupter switches are installed with the grounding position configured to ground the incoming feeder.
7. Transformers are equipped with low-voltage automatic network protectors.
8. The main low-voltage distribution equipment is low-voltage switchgear containing a main breaker for each transformer as well as bus tie breakers between bus segments.
9. All low-voltage mains and ties operate normally closed so that all sources are normally operating in parallel. The switchgear serves as the low voltage spot network bus.
 - a. Low-voltage transfer schemes and breaker interlock schemes are not acceptable.

c. Spot network distribution scheme is illustrated on following page:

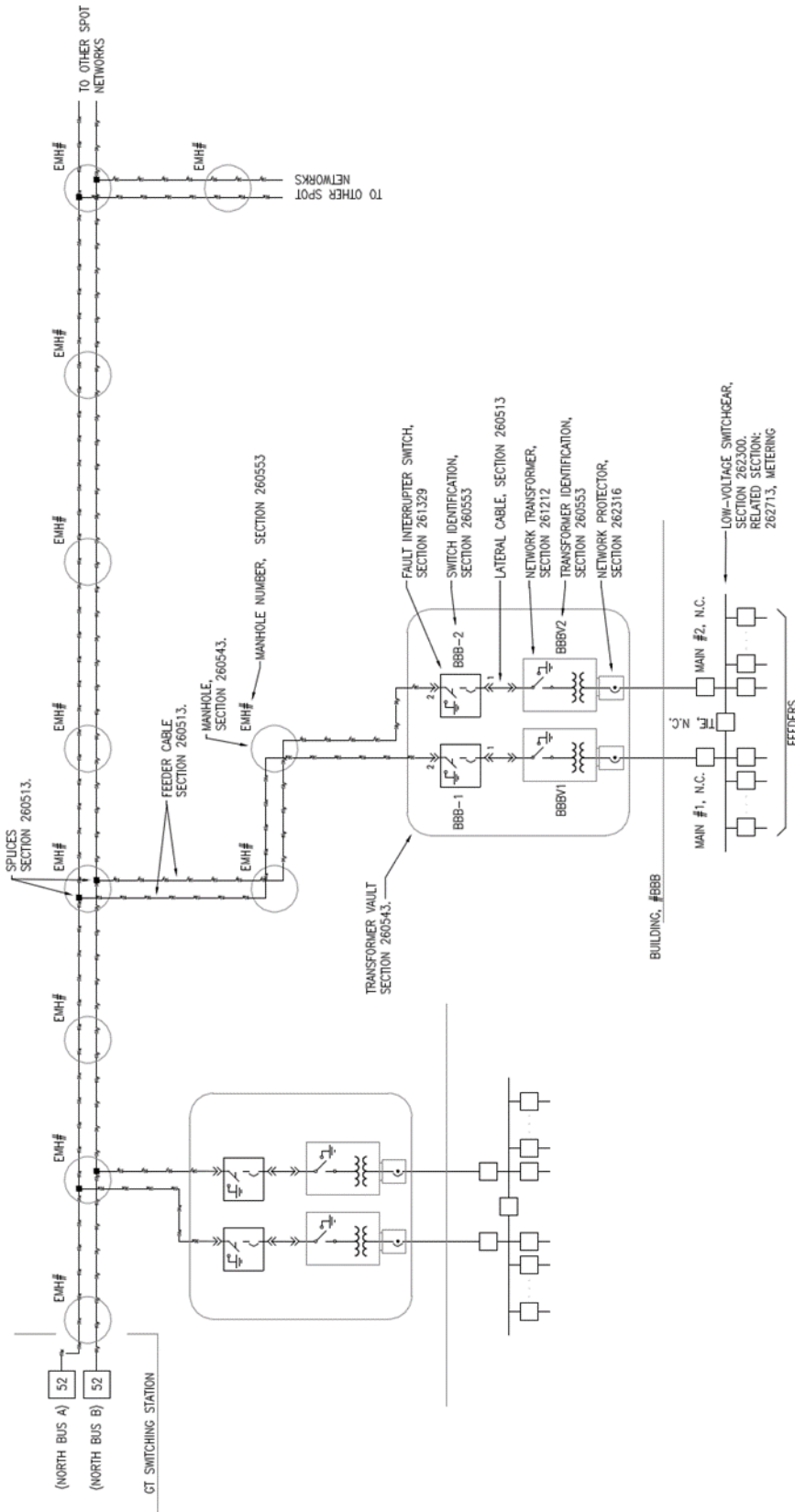

DISTRIBUTION SCHEME:
SPOT NETWORK
 GENERAL CAMPUS ELECTRICAL DISTRIBUTION
 FOR CRITICAL FACILITIES

FOR ILLUSTRATION ONLY. THIS IS NOT AN ACTUAL GT
 ELECTRICAL DISTRIBUTION SYSTEM 1-LINE.
 SECTION NUMBERS REFER TO THE GEORGIA TECH DESIGN AND
 CONSTRUCTION STANDARDS, ALSO KNOWN AS THE YELLOW BOOK.

F. Cable Ampacity

1. The feeders exiting the switching station are designed for a total capacity of nominally 80MVA with full redundancy. The basis for this is thermal analysis of deep and high density ductbanks between the switching station and the campus.
2. Except for projects specifically related to system planning or widespread changes to the system, the Facilities Design and Construction is responsible for managing feeder assignments for new loads. The Consultant shall coordinate work with Facilities Design and Construction.
3. Campus feeder cable sizes shall be as listed in other Sections except where necessary to increase cable sizes due to ductbank depth, ductbank density or ambient temperature. Additional information will be provided as needed. Thermal analysis and ampacity calculation for new work is the responsibility of the Engineer.

G. Existing Deficiencies:

1. While largely consistent, there are a few deficiencies in the existing system. Where these deficiencies are encountered, new work shall be arranged to correct the deficiency or to facilitate its future correction to the maximum extent practical. Do not replicate existing deficiencies in new construction.
 - a. Some examples of known deficiencies include but are not limited to:
 1. 19.8kV transfer switches, both manual and automatic should be eliminated from network feeder pairs N1&N2, and N3&N4.
 2. 200A subloops should be eliminated.
 3. 200A dead-front interfaces should be replaced with 600A dead-break interfaces.
 - a. G&W Clip limiters should be removed from feeders L1, L2, L3, L4, L5 and L6 after the elimination of 200A interfaces.
 4. Aerial distribution should be eliminated.

H. Codes and Standards

1. Electrical distribution system work shall comply with NFPA 70, National Electrical Code and ANSI C2, National Electrical Safety Code as well as other applicable codes adopted by the State of Georgia.

I. Construction Documents

1. Provide complete construction drawings including Civil Engineering design work as required for compliance with this section. Show new work as well as the extent of demolition. Show existing utilities and surface features which may be affected by excavation. Specify erosion control measures and surface restoration work as required for each project.

1. Show all electrical and communications ductbanks and manholes to scale in plan view including the proper widths and bending radii of ductbanks.
2. Show all Georgia Tech cable numbers, equipment numbers and manhole numbers on the plans. Include existing and new equipment and manholes in the project vicinity. Contact Facilities Design and Construction during project design for cable, equipment and manhole numbers.

2.01 Products

(Not used)

3.01 Execution

- A. Where electrical and telecommunications distribution cables and equipment are left unused by the work of the project, or were existing in the site and not used by the project, remove all such materials to the fullest extent possible except where Facilities Design and Construction designates items to remain. Provide all splicing and termination work to accomplish the removal and to leave remaining equipment and cables in service and operating.
- B. Provide appropriate means of protection for surrounding facilities, surfaces, landscaping and the public as well as means to minimize the disruption of campus usage by faculty, staff, students and the general public.
- C. Outage work affecting portions of the campus or buildings not solely occupied by the contractor shall be scheduled after hours and on weekends and holidays. Such outages shall be requested in writing by the contractor and are subject to the approval of the office of Facilities Design and Construction. Requests shall be submitted at least three weeks prior to the start of the proposed outage.
- D. Phasing at existing equipment to remain shall remain exactly as existing. Where new work results in incorrect or changed phasing at any existing equipment, the new work shall be corrected immediately and at no additional expense to the owner.
- E. All medium voltage switching operations will be performed by Georgia Tech personnel. Phasing, safety grounding, and protective equipment is the responsibility of the contractor.

END OF SECTION

261212 – LIQUID-FILLED NETWORK TRANSFORMERS

1.01 General

- A. Application:
 - 1. Network transformers for use in the campus distribution system spot network distribution scheme.
- B. General:
 - 1. Network transformers shall be installed in vaults. See Section 260543.
 - 2. Network transformers shall be installed with secondary network protectors. Network protectors are addressed in Section 262316.
 - 3. Network transformers shall be protected on the primary side by fault interrupter switches. See Section 261329.
 - 4. Network transformers are applied in pairs sized for full redundancy. Each transformer of each pair shall be sized to carry the full connected demand load continuously.

2.01 Products

- A. ANSI C57.12.40 compliant liquid-filled, 2-winding, three-phase delta-wye subway network type, suitable for frequent or continuous submersion.
- B. Insulating Liquid: High fire point, natural ester dielectric coolant UL listed for use in transformers and complying with NFPA 70 requirements. Fire point of not less than 300° C when tested according to ASTM D 92. Insulating liquid shall be made from edible vegetable oils and shall have low toxicity, shall be biodegradable and shall be nonhazardous. Insulating liquid shall be equal to Cargill Envirotemp FR3.
- C. Sealed-tank construction of sufficient strength to withstand an internal pressure of 7 psi without permanent distortion. The cover shall be welded. The transformer shall remain effectively sealed for top oil temperatures from -5°C to 105°C.
 - 1. Liquid-filled primary terminal chamber and primary switch chamber welded to the main tank. Terminal chamber and switch chamber covers shall be bolted. Bushings between the primary terminal chamber and the switch chamber and between the switch chamber and the main tank shall be sealed to prevent the interchange of fluids. Terminal chamber and switch chamber shall have fill, level check, and drain plugs.
 - 2. Flat panel radiators suitable for submerged operation as well as for dry operation, rigidly supported on tank walls.
 - 3. Secondary throat and brackets for direct mounting of secondary network protectors.
 - 4. Exterior paint finish consisting of corrosion resistant primer and black finish coat complying with ANSI C57.12.32.
- D. Primary bushings for incoming cable connection shall be IEEE 386 compliant dead-break bushings for use with 600A dead-break separable connectors. Primary bushings shall be mounted on top of the primary terminal chamber.

- E. The primary switch shall be liquid-immersed, three-position, open-close-ground for de-energized operation. Switch withstand rating and continuous current rating shall be coordinate with the transformer rating. Switch shall be adequately sized for continuous full load operation of the transformer and shall withstand the full short-circuit current duty of the transformer without damage.
 - 1. The switch operating shaft shall be electrically interlocked to prevent switch operation while the transformer is energized. Interlock shall be disengaged when the transformer is de- energized.
 - 2. Primary switch shall be equipped with sequential grounding or shall be equipped with phasing tubes.
- F. Secondary connection shall be by means of a standard throat for direct mounting of a network protector. Secondary bushings shall be located inside the throat and shall be externally replaceable. Terminals shall be provided with flexible shunts for connection of throat-mounted network protectors.
- G. Neutral terminal shall be welded to the tank wall.
 - 1. Where necessary, neutral bushing shall be insulated and provided with a ground strap.
- H. No-load tap changers are not required. If furnished, tap changers shall be heavy duty type, full capacity, with 2 ½% taps, 2AN and 2BN with a position indicator. Tap changer shall be accessible via a threaded plug in the top cover. Furnish a tap changer handle or wrench with the transformer.
- I. Include the following:
 - 1. Drain and sampling valve
 - 2. 1" upper fill plug and filter press connection
 - 3. Pressure / vacuum gage
 - 4. Magnetic liquid level gage
 - 5. Top oil thermometer with resettable drag-hand.
 - 6. Transformer tank air test fitting.
 - 7. Automatic pressure relief device with automatic re-sealing
 - 8. One or more handholes for access to bushings
- J. Ratings:
 - 1. 300kVA to 2500kVA as determined by the Engineer.
 - 2. KNAN 55°C, KNAN 65°C, or KNAN 55°C/65°C as determined by the Engineer
 - 3. Impedance:
 - a. 7% Z for transformers rated over 1000kVA
 - b. 5% Z for transformers rated 1000kVA and less
 - c. Impedances other than standard impedance are not acceptable.

3.01 Execution

- A. Install network transformers in secured vaults. Transformers shall not be accessible to unqualified persons.
- B. Install network transformers level and plumb on 6” raised curbs. Transformers shall not rest directly on vault floors.
- C. Apply slight positive pressure to tanks. Use dry nitrogen.
- D. Where tap changers are provided, test secondary voltage after energizing. Adjust taps so that the secondary voltage is between 100% and 102.5% of the nameplate voltage.

END OF SECTION

261219 – PAD-MOUNTED LIQUID-FILLED TRANSFORMERS

1.01 General

- A. Application:
 - 1. Pad-mounted transformers for use in the campus electrical distribution system.
 - 2. Pad-mounted transformers used in the primary loop distribution scheme shall be rated 2500kVA or less.

2.01 Products

- A. ANSI C57.12.34 compliant liquid filled, dead-front, radial feed, 2-winding three phase, delta-wye with tamperproof compartmental enclosure suitable for use in areas accessible to the general public.
 - 1. Clamshell enclosure or other types without internal primary and secondary compartment barriers are not acceptable.
- B. Insulating Liquid: High fire point, natural ester dielectric coolant UL listed for use in transformers and complying with NFPA 70 requirements. Fire point of not less than 300° C when tested according to ASTM D 92. Insulating liquid shall be made from edible vegetable oils and shall have low toxicity, shall be biodegradable and shall be nonhazardous. Insulating liquid shall be equal to Cargill Envirotemp FR3.
- C. Sealed-tank construction of sufficient strength to withstand an internal pressure of 7 psi without permanent distortion. The cover shall be welded. The transformer shall remain effectively sealed for top oil temperatures from -5°C to 105°C.
- D. Primary bushings for incoming cable connection shall be IEEE 386 compliant dead-break bushings for use with 600A dead-break separable connectors. Provide three bushings for radial feed.
- E. Transformers shall be equipped with (3) bayonet fuses in series with internal partial range current limiting fuses.
 - 1. Furnish three spare bayonet fuses.
- F. Secondary terminals shall be spade type, located in the secondary compartment. The neutral bushing shall be provided with a grounding strap.
- G. No-load tap changers are not required. If furnished, tap changers shall be heavy duty type, full capacity, with 2 ½% taps, 2AN and 2BN with a position indicator. Tap changer shall be accessible in the primary compartment.
- H. Include the following:
 - 1. Drain and sampling valve
 - 2. 1" upper fill plug and filter press connection
 - 3. Pressure / vacuum gage
 - 4. Magnetic liquid level gage
 - 5. Top oil thermometer with resettable drag-hand.

6. Transformer tank air test fitting.
7. Automatic pressure relief device with automatic re-sealing
8. One or more handholes in the tank cover.

3.01 Execution

- A. Install pad-mounted transformers level and plumb on flat cast-in-place concrete pads. Do not provide cable pits below transformers.
 1. Pad top elevation shall be no less than 4" and no more than 8" above grade at operating side or compartments.
 2. Pads shall include a window sized to coordinate with the front compartment of the transformer. Window shall be filled with gravel. Do not pour pads solid around conduits.
 3. Conduits shall be stubbed vertically 1" above the pad within each compartment. End bells shall be installed on all primary conduits. Primary conduits shall be located within the primary compartment. Secondary and metering conduits (where present) shall be located in the secondary compartment.
 4. Pads shall extend no more than 4" beyond the transformer footprint on all sides.
 5. Pad edges shall be chamfered.
 6. Transformer tank and front compartment shall be secured to pad with anchor bolts. Where tank base or front compartment are furnished without anchor bolt holes, install galvanized hold-down cleats.
 7. Transformers should be placed away from vehicular and pedestrian traffic. Where transformers must be in proximity to vehicular traffic areas, bollards are acceptable. Bollards shall not obstruct door swings or work space.
 8. Provide clear work space of at least 10' clear space in front of transformers, and 3' on all other sides
 9. Typical transformer pad:

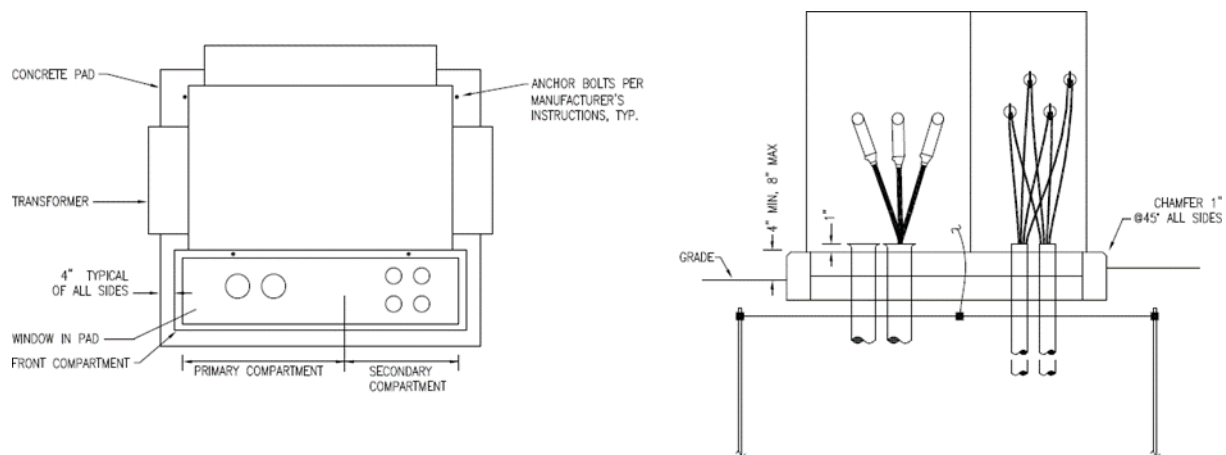

- B. Install cable tags in accordance with Section 260553.

- C. Transformer identification labels shall be in accordance with Section 260553.
- D. Provide and install padlocks on all doors. Coordinate work with keying by the Owner. Locks shall be keyed and in place prior to energizing.
- E. Where metering CTs and/or metering voltage taps are to be installed at the transformer, coordinate installation of such equipment and install a separate conduit from the secondary compartment to the meter location.

END OF SECTION

261328 – MEDIUM VOLTAGE LOOP SWITCHES

1.01 General

A. Application:

1. Medium voltage loop switches shall be used to connect transformers to campus 19.8kV primary distribution loops.
2. Example –

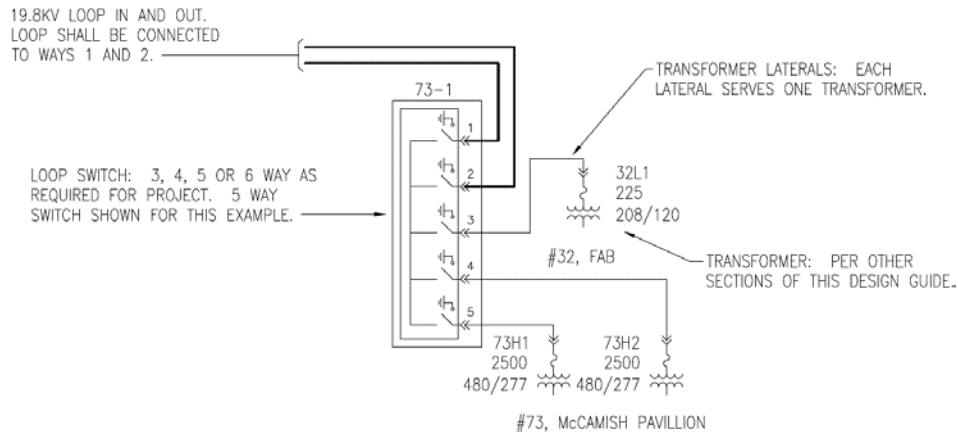

2.01 Products

A. Loop Switches

1. 3-position grounding, manual, load-break, gang operated, dead-front with IEEE 386 compliant 600A dead-break bushings.
2. Low-profile, pad-mounted, tamperproof for above grade applications. Above grade application is preferred.
3. Submersible type for below grade application.
4. Switches shall have viewing windows to allow direct observation of contact position and grounding contacts for each switched way.
5. Switches shall be operated via a single hub or operating handle per switched way.
6. Switch operating handles or hubs shall be located in separate physical compartments from the bushings and cable terminations so that the switch can be operated with cable compartments closed. For subsurface switches, bushings shall be remote from operating handles or hubs to avoid compromising the safety of operating personnel.
7. Switches shall include means for storage of removable operating handles within the switch housing (pad-mounted) or on the switch tank (subsurface).
8. Switch operating hubs, switch handles and switch housings shall include padlocking provisions.
9. SF6 insulated switches shall include a fill port for the addition of SF6 gas.
10. SF6 insulated switches shall include permanent pressure gages visible from the operating compartment or operating side of the switch.
11. Loop switches shall not include overcurrent controls.

12. Minimum ratings:
 - a. 25kV class, 125kV BIL
 - b. 600A continuous and load break
 - c. 16kA sym
13. Basis of Design: S&C Vista 330, 440, 550, or 660 with optional 16kA rating. Equivalent products may be accepted subject to compliance with this Section.

3.01 Execution

- A. Install pad-mounted switches on flat cast-in-place concrete pads. Do not provide cable pits below switches.
 1. Pad top elevation shall be no less than 4” and no more than 8” above grade at operating side or compartments.
 2. For the Basis of Design switch models in pad-mounted applications, conduits shall be stubbed vertically 1” above the pad located on the center phase cable centerline for each compartment. Spare conduits shall be placed between these conduits. This results in very close clearances between conduits. End bells shall be installed on all conduits except that they may be omitted from spares due to space limitations. All conduits shall be stubbed along a single line parallel to the switch tank. Where switches other than the basis of design are accepted, similar requirements shall apply and shall be adapted to the physical configuration of the switch being installed.
 3. Pads shall extend no more than 4” beyond the switch enclosure footprint on all sides.
 4. Pad edges shall be chamfered.
 5. Switch tanks and housings shall be secured to pads with anchor bolts as recommended by the switch manufacturer.
 6. Switches should be placed away from vehicular and pedestrian traffic. Where switches must be in proximity to vehicular traffic areas, bollards are acceptable. Bollards shall not obstruct door swings or work space.
 7. Provide clear work space of at least 3’ at operator side or operator compartments and at least 10’ clear space in front of all cable termination compartments.

8. Typical pad-mounted switch layout (5-way shown, others similar):

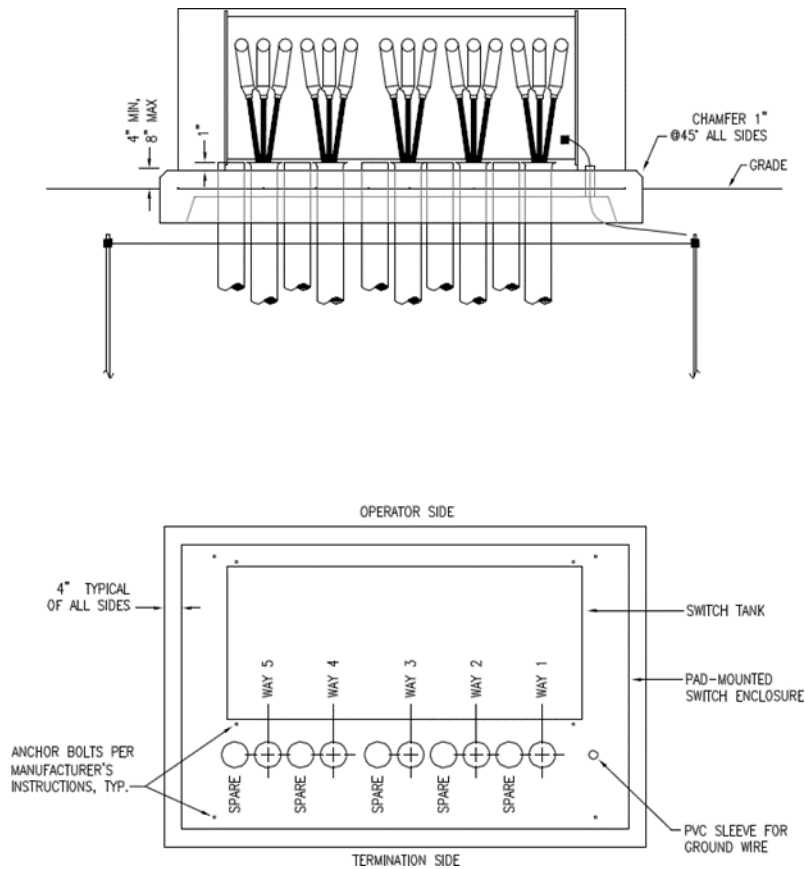

B. Install subsurface switches in precast concrete vaults.

1. Vault tops shall be set at least 2" above grade in unpaved areas.
2. Contact viewing windows shall be no more than 12" below the top surface of the vault. Padlocking provisions on operator hubs and operating handles shall be located such that they are easily reached by operating personnel on grade. Gas pressure gages shall be visible to operating personnel on grade. All normal operations including checking gas pressure and operating switches will be conducted by personnel on grade. Vault entry by personnel shall not be required to accomplish these functions.
3. Vaults shall have internal galvanized steel framing to support switches at the proper elevation.
4. Avoid placing vaults in vehicular and pedestrian traffic areas.
5. Provide clear work space of at least 3' on grade at operator side or operator compartments and at least 10' clear space in front of all switch bushings.
6. Vaults shall include pad-lockable spring-assisted access doors sized to provide full access to the switch operating hubs or handles, contact viewing windows, and pressure gages.

7. Vault structure and doors shall not obstruct the movement of contact viewing window covers or switch operating handles.
 8. Vault tops shall include doors for access to cable termination areas. Such doors shall be sized and located to provide full personnel access and clearances for cable installation, termination, and attachment to switch bushings.
 9. Vaults shall be provided with drains and gravel pits.
 10. Cables shall be supported so that they are at least 6" above the vault floor.
 11. Comply with NEC 110 part V.
 12. See Section 260543.
- C. Install cable tags and fault indicators in accordance with other Sections. Fault indicators shall have remote indicator heads. Install indicator heads in viewing windows at pad-mounted switches. Install indicator heads adjacent to operating handles or hubs at subsurface switches. Install fault indicators on each switched way.
- D. Switch number labels shall be in accordance with Section 260553.
- E. Provide and install padlocks on all switch operating hubs or handles, vault access doors and switch enclosure doors. Coordinate work with keying by the Owner. Locks shall be keyed and in place prior to energizing cables and switches.

END OF SECTION

261329 – MEDIUM VOLTAGE FAULT INTERRUPTER SWITCHES

1.01 General

A. Application:

1. Medium voltage fault interrupter switches shall be used to connect network transformers to campus 19.8kV primary network feeders.
2. In addition to switching and grounding capabilities, medium voltage fault interrupter switches provide overcurrent protection for network transformers and laterals.
3. Example –

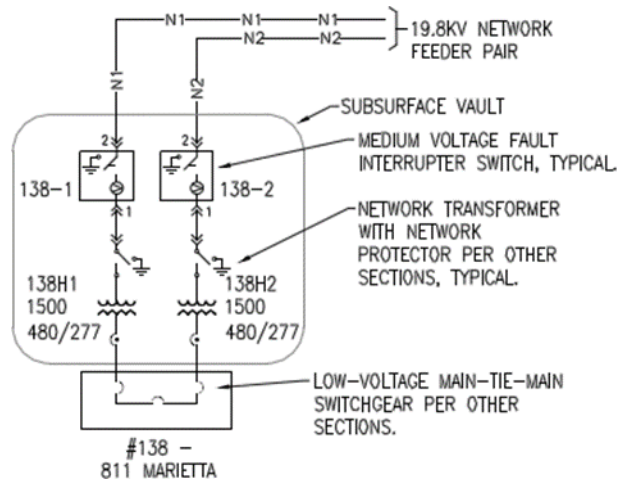

2.01 Products

A. Fault Interrupter Switches

1. 3-position close-open-ground switch, manual gang operation, dead-front with IEEE 386 compliant 600A dead-break bushings.
 - a. Feeder entrance way shall be load-break and grounding only, without fault interrupters.
 - b. Transformer lateral ways shall have electronically tripped gang-operated vacuum interrupters.
2. Submersible type where installed within the transformer vault or in a separate switch vault.
3. Low-profile, pad-mounted, tamperproof for above grade applications.
4. Switches shall have viewing windows to allow direct observation of contact position, interrupter status and grounding contacts for each switched way.
5. Switches shall be operated via a single hub or operating handle per switched way. Switch handle or operating hub shall provide fault interrupter resetting as well as close-open-ground switching functions.

6. Switch operating handles or hubs shall be located in separate physical compartments from the bushings and cable terminations so that the switch can be operated with cable compartments closed. For subsurface switches, bushings shall be remote from operating handles or hubs to avoid compromising the safety of operating personnel.
7. Switches shall include means for storage of removable operating handles within the switch housing (pad-mounted) or on the switch tank (subsurface).
8. Switch operating hubs, switch handles and switch housings shall include padlocking provisions.
9. SF₆ insulated switches shall include a fill port for the addition of SF₆ gas.
10. SF₆ insulated switches shall include permanent pressure gages visible from the operating compartment or operating side of the switch.
11. Fault interrupter switches shall have line-powered, programmable overcurrent controls with selectable standard fuse and relay curves. At minimum, curve selections shall include E fuse curves, very inverse and extremely inverse relay curves and selectable definite time delay. Trip units shall include separate settings for ground fault.
12. Minimum ratings:
 - a. 25kV class, 125kV BIL
 - b. 600A continuous and load break
 - c. 16kA sym
13. Basis of Design: S&C Vista 201 or 312 with optional 16kA rating. Equivalent products may be accepted subject to compliance with this Section.
 - a. Feeder termination shall be on way 2 for Vista 201 switches.
 - b. Feeder termination shall be on way 1 for Vista 312 switches.

3.01 Execution

- A. Install pad-mounted switches on flat cast-in-place concrete pads. Do not provide cable pits below switches.
 1. Pad top elevation shall be no less than 4” and no more than 8” above grade at operating side or compartments.
 2. For the Basis of Design switch models in pad-mounted applications, conduits shall be stubbed vertically 1” above the pad located on the center phase cable centerline for each compartment. Spare conduits shall be placed between these conduits. This results in very close clearances between conduits. End bells shall be installed on all conduits except that they may be omitted from spares due to space limitations. All conduits shall be stubbed along a single line parallel to the switch tank. Where switches other than the basis of design are accepted, similar requirements shall apply and shall be adapted to the physical configuration of the switch being installed.
 3. Pads shall extend no more than 4” beyond the switch enclosure footprint on all sides.
 4. Pad edges shall be chamfered.

5. Switch tanks and housings shall be secured to pads with anchor bolts as recommended by the switch manufacturer.
 6. Switches should be placed away from vehicular and pedestrian traffic. Where switches must be in proximity to vehicular traffic areas, bollards are acceptable. Bollards shall not obstruct door swings or work space.
 7. Provide clear work space of at least 3' at operator side or operator compartments and at least 10' clear space in front of all cable termination compartments.
 8. Pads and installation of pad-mounted fault interrupter switches shall be similar to that described in Section 261328 for medium voltage loop switches.
- B. Install subsurface switches in the transformer vault or in separate precast concrete switch vaults.
1. Vault tops shall be set at least 2" above grade in unpaved areas.
 2. Contact viewing windows shall be no more than 12" below the top surface of the vault. Padlocking provisions on operator hubs and operating handles shall be located such that they are easily reached by operating personnel on grade. Gas pressure gages shall be visible to operating personnel on grade. All normal operations including checking gas pressure and operating switches will be conducted by personnel on grade. Vault entry by personnel shall not be required to accomplish these functions.
 3. Provide clear work space of at least 3' on grade at operator side or operator compartments and at least 10' clear space in front of all switch bushings.
 4. Vaults shall have internal galvanized steel framing to support switches at the proper elevation.
 5. Provide pad-lockable spring-assisted access doors sized to provide full access to the switch operating hubs or handles, contact viewing windows, and pressure gages.
 6. Vault structure and doors shall not obstruct the movement of contact viewing window covers or switch operating handles.
 7. Where switches are installed in a separate switch vault and not in the transformer vault, switch vaults shall be similar to that described in Section 261328 for medium voltage loop switches.
 8. See Section 260543.
- C. Install cable tags and fault indicators in accordance with other Sections. Fault indicators shall have remote indicator heads. Install indicator heads in viewing windows at pad-mounted switches. Install indicator heads adjacent to operating handles or hubs at subsurface switches. Install fault indicators on each switched way.
- D. Switch number labels shall be in accordance with Section 260553.
- E. Provide and install padlocks on all switch operating hubs or handles, vault access doors and switch enclosure doors. Coordinate work with keying by the Owner. Locks shall be keyed and in place prior to energizing cables and switches.

END OF SECTION

262200 – LOW-VOLTAGE TRANSFORMERS

1.01 General

- A. Scope: Distribution and buck-boost dry-type transformers rated 600V and less.

2.01 Products

- A. Comply with UL 1561.
- B. Comply with current energy efficiency standards.
- C. Provide full capacity voltage taps, 2 @ 2.5% A&BN for transformers rated 25kVA and larger.

3.01 Execution

- A. Comply with NECA 409.
- B. Evaluate the intended loading of each transformer and furnish K-factor transformers, electrostatically shielded transformers or other types as needed.
- C. Provide means to remove heat dissipated by transformers in enclosed spaces.
- D. Select installation locations, mounting methods and vibration isolators to prevent objectionable noise transmission.
- E. Install floor mounted transformers on concrete pads.
- F. Connect transformers with wire in flexible conduit or cable.

END OF SECTION

262300 – LOW-VOLTAGE SWITCHGEAR

1.01 General

- A. Application: Where suitable for the application, switchgear may be used at any point in any electrical system.
 - 1. Low-voltage double-ended switchgear shall be used as main distribution equipment in spot- network supplied buildings.
 - 2. Low-voltage double ended switchgear used as main distribution equipment in spot-network supplied buildings shall be main-tie-main with normally closed breakers. Interlocks and transfer schemes are not acceptable.

2.01 Products

- A. Switchgear of any ampere rating used as main distribution equipment shall be equipped with an arc- flash hazard reduction system.
- B. Circuit breaker compartments shall include shutters to automatically cover line-side bus connections when breakers are withdrawn.
- C. Double-ended switchgear shall have mimic bus
- D. Provide breaker lifting devices for all switchgear.
- E. Switchgear shall have IR scanning windows.
- F. Mains, ties and feeders shall have coordinated ground fault protection.
- G. Where main incoming feeders are to be metered, the following shall be factory installed:
 - 1. Current transformers on each phase of each incoming line
 - 2. Voltage taps on each phase and neutral of each incoming line
 - 3. Voltage tap fuses
 - 4. Voltage tap disconnecting means
 - 5. Terminal blocks for the connection of an outboard power and energy meter. The terminal blocks used for current circuits shall be shorting type.
No power and energy meter shall be installed in switchgear. Coordinate with Section 262713.
- H. Where feeders 1200A and larger are to be metered, the following shall be factory installed:
 - 1. Current transformers on each phase of each feeder which is to be metered.
 - 2. Bus voltage taps on the same bus segment as the feeder to be metered.
 - 3. Voltage tap fuses
 - 4. Voltage tap disconnecting means
 - 5. Terminal blocks for the connection of an outboard power and energy meter. The terminal blocks used for current circuits shall be shorting type.
No power and energy meter shall be installed in switchgear. Coordinate with Section 262713.

- I. Where feeders smaller than 1200A are to be metered, CT's 1200A and smaller shall be installed in remote pull boxes. CTs smaller than 1200A shall not be installed on feeders in switchgear.
- J. Switchgear shall comply with ANSI C37.
- K. Switchgear bus shall be copper. Aluminum is not acceptable.

3.01 Execution

- A. Provide at least one spare breaker and space for future additional breakers in all switchgear. Spaces shall include bussing, racking, shutters and provisions for the installation of breakers. Switchgear shall include provisions for expansion. Place equipment such that space for expansion is available and usable.
- B. Switchgear shall be installed on raised concrete pads. Pads shall not be oversized and shall not encroach on electrical working space.

END OF SECTION

SECTION 262316 – NETWORK PROTECTORS

1.01 General

- A. Application:
 - 1. Low-voltage automatic network protectors for use in secondary spot networks.

2.01 Products

- A. Network Protectors
 - 1. IEEE C57.12.44 automatic AC network protector, suitable for frequent or continuous submersion.
 - 2. Deadfront, drawout type with positive interlocks.
 - 3. Spring-closed mechanism with close and latch current rating.
 - 4. Network protector assembly shall include the breaker unit, network relay, fuses, and all current transformers, voltage transformers, control power transformers, control components and wiring within a single submersible assembly.
 - 5. Network protectors shall be equal to Cutler-Hammer type CM-52 or Richards 147NP.
 - 6. Breaker:
 - a. Electrically-operated, three-pole, spring-closed breaker with close and latch current rating.
 - b. Manual, hand-operated levering system for connecting and disconnecting the breaker interlocked to trip the breaker prior to racking out. Breaker and enclosure equipped with rollers and extension rails for full withdrawal of the breaker from the enclosure.
 - c. Equipped with mechanical contact position indicators and operations counter.
 - 7. Enclosure
 - a. Submersible enclosure with hinged and bolted door suitable for continuous submersion.
 - b. Direct mounting to submersible network transformer secondary throat and supported by network transformer.
 - c. Viewing windows in door for viewing of contact position indicators and operations counter.
 - d. External three-position open-auto-close operating handle.
 - e. Top-mounted load terminals.
 - f. Load side fuses mounted within the main enclosure or in top-mounted submersible fuse housings with integral load terminals.
 - g. Equipped with Schrader valves for purging and pressurizing network protector housings. Provide permanently installed pressure-vacuum gauges with stop valves.

8. Network Relay
 - a. Microprocessor based network relay to provide automatic tripping and closing of network protector. Relay mounted inside submersible housing with breaker unit on plug-in base or similar arrangement to facilitate relay testing and replacement.
 - b. Network relays shall sense load current, transformer voltage and voltage across open breaker contacts.
 - c. Trip contact shall close if reverse positive-sequence power flow is out of the network.
 - d. Trip contact shall close for reversed or rolled phase conditions on the network or on the transformer.
 - e. Trip contact shall close on reverse transformer magnetizing current.
 - f. Close contact shall close if the ensuing positive sequence power flow will be into the network.
 - g. Manual closing shall be blocked when the network relay trip contact is closed.
 - h. Network relay trip characteristic shall be field selectable and shall include watt and watt-var characteristics.
 - i. Network relay closing characteristic shall be field selectable and shall include straight master line and circular close characteristics. Closing shall be determined by master and phasing lines.
 - j. Reverse current de-sensitizing or time-delay functions shall not be provided or shall be provided with means to defeat de-sensitizing and time delay functions via field selectable settings.
 - k. Visible indicators shall be provided to indicate trip, close and float conditions.
 - l. Settings shall be field selectable and shall be entered by means of a programmer or software and portable computer.
9. Fuses:
 - a. Fuses shall be current-limiting type, coordinated with the network protector and transformer damage curve.

3.01 Execution

- A. Test enclosure for leaks. Purge with dry nitrogen and leave under slight positive pressure.
- B. Set relays and test with a network protector relay test set, Megger NTS-300 or equal. All relay setting and testing shall be done by a qualified test engineer.
 - 1. Standard settings for low-voltage network protectors used on the Georgia Tech electrical distribution system:
 - a. Trip: 0.1% of CT rating @ 180E
 - b. Time Delay: 0
 - c. Trip Characteristic: Watt
 - d. Closing:
 - 1. Master Line @0E: 0.6V on 125V base for 277/480V networks
 - 2. Phasing Line: -5E
 - e. CPU Failure Trip
 - 2. Settings shall be reviewed and approved by the engineer prior to setting.
- C. Load terminals shall be covered with waterproof insulation after connection of load cables.
 - 1. Insulation shall be 3M Scotchfil insulating putty or equal overwrapped with 3M Scotch 33 or equal self-fusing rubber splicing tape and jacketed with vinyl electrical tape. Completed insulation shall be shaped to shed water.

END OF SECTION

262413 – SWITCHBOARDS

1.01 General

- A. Application: Where suitable for the application, switchboards may be used at any point in any electrical system except as follows.
 - 1. Switchboards shall not be used as main distribution equipment in spot-network supplied buildings.

2.01 Products

- A. Switchboard bus shall be copper. Aluminum is not acceptable.
- B. Switchboards of any ampere rating used as main distribution equipment shall be equipped with an arc-flash hazard reduction system.
- C. Where switchboard mains are equipped with ground fault protection, feeders shall have coordinated ground fault protection.
- D. Where main incoming feeders are to be metered, the following shall be factory installed: current transformers on each phase of the incoming line, voltage taps on each phase and neutral of the incoming line, voltage tap fuses, voltage tap disconnecting means and terminal blocks for the connection of an outboard power and energy meter. The terminal blocks used for current circuits shall be shorting type. No power and energy meter shall be installed in a switchboard. Coordinate with Section 262713.
- E. Switchboards shall comply with UL 891 and NEMA PB-2.

3.01 Execution

- A. Provide space for future breakers in all switchboards. Spaces shall include bussing and provisions for the installation of breakers.
- B. Switchboards shall be installed on raised concrete pads. Pads shall not be oversized and shall not encroach on electrical working space.
- C. Installation shall comply with NECA 400.

END OF SECTION

262416 – PANELBOARDS

1.01 General

- A. Application: Where suitable for the application, panelboards may be used at any point in any electrical system except as follows.
 - 1. Panelboards shall not be used as main distribution equipment in spot-network supplied buildings.

2.01 Products

- A. Panelboard bus shall be copper. Aluminum is not acceptable.
- B. Branch circuit breakers shall be bolt-on
- C. Series-rated devices may be used.
- D. Panelboards shall comply with UL 67 and NEMA PB-1.

3.01 Execution

- A. Where practical, panelboards should be surface mounted and located in electrical closets or in dedicated space in mechanical rooms or other utility areas. Flush mounting and installation in finished areas is acceptable where necessary. Where branch circuit panelboards are flush mounted, provide three spare $\frac{3}{4}$ " conduits stubbed from the panelboard to an accessible ceiling.
- B. Provide space for future breakers in all panelboards and distribution panels. Spaces shall include bussing and provisions for the installation of breakers.
- C. No metering equipment shall be installed in panelboards
- D. Installation shall comply with NECA 407

END OF SECTION

SECTION 262419 – MOTOR CONTROL CENTERS

1.01 General

(not used)

2.01 Products

- A. Comply with UL 845 and NEMA ICS-18.
- B. All bus shall be copper.
- C. Each controller shall be provided with a hand/off/auto switch and LED run light except where this requirement is in conflict with the project program or applicable codes.
- D. Provide remote racking with remote racking motor or other suitable means for arc-flash risk mitigation.
- E. Electronic soft starters shall be equipped with run contactors to bypass the soft starter when the motor is running.

3.01 Execution

- A. Motor control centers shall be installed on raised concrete pads. Pads shall not be oversized and shall not encroach on electrical working space.
- B. Installation shall comply with NECA 402.

END OF SECTION

262500 – ENCLOSED BUS ASSEMBLIES

1.01 General

- A. Scope: Low voltage and medium voltage enclosed bus assemblies (busway).
- B. Application: Where suitable for the application, indoor and outdoor feeder busway and indoor plug- on busway may be used at any point in any electrical system except as follows.
 - 1. In critical facilities, busway shall not be used except where the program is facilitated by the limited use of busways such as the use of plug-on busway in a lab or high-bay area. Busway shall not be used as a main feeder, service entrance or as feeder in these facilities.

2.01 Products

- A. All bus shall be copper.
- B. Busways shall be totally enclosed, non-ventilated.
- C. Where installed in buildings with fire sprinkler systems, busways shall be sprinkler-safe.

3.01 Execution

- A. Where installed outdoors or in unconditioned space, busways shall be equipped with thermostatically controlled heaters to prevent condensation
- B. Installation shall comply with NECA 408.

END OF SECTION

262713 – ELECTRICITY METERING

1.01 General

- A. Scope: This Section includes all electric power and energy meters.
 - 1. New power and energy meters are additions to an existing campus-wide energy metering system. New meters and installation shall conform to the requirements stated herein in order to maintain the consistency and uniformity of the campus-wide metering system.
- B. Application:
 - 1. All facilities connected to the campus electric distribution system or to other campus electric supply shall be equipped with power and energy meters on each incoming line.
 - 2. Additional power and energy meters shall be installed for cost allocation where multiple campus entities or tenants occupy or use the facility. The extent of metering work for cost allocation must be determined in cooperation with Facilities Design and Construction representatives. Examples of occupancies or uses within or associated with a building which typically require submetering include but are not limited to: parking decks or lots, laundries, food service, retail, cellular carriers, and street lighting.
 - 3. Additional power and energy meters shall be installed to support M&V plans where applicable.
- C. Construction Documents:
 - 1. Construction documents shall show meter locations, meter types, CT ratings and types, field wiring and communications wiring.
 - 2. Facilities Design and construction will provide metering equipment schedules, field wiring diagrams and communications wiring 1-line diagrams for the Engineer's use. Details shall be included without change or may be redrawn or adapted as needed. Where redrawn or adapted, all elements of the details and schedules provided by Facilities Design and Construction shall be present in the final construction documents.
 - 3. Metering details and schedules are project specific. The Engineer shall share information regarding feeder ratings and distribution equipment types so that Facilities Design and Construction can tailor the details and schedules to the project.
 - 4. An example of meter details for a large project appears at the end of this Section. This example is for information only. Actual details for use in construction documents will be provided as noted above.

2.01 Products

- A. Meters:
 - 1. All meters shall be PowerLogic ION series and shall be integrated into the existing campus PowerLogic metering system.
 - 2. Meters shall be furnished in factory-fabricated, pre-wired enclosures and shall be field- installed separately from switchboards, switchgear, panelboards or other equipment.

3. Meters shall be one of the following types:
 - a. Indoor mains: PowerLogic ION 7550 with ethernet port and gateway in factory assembled enclosure PowerLogic 9761E7550 series.
 - b. Indoor submeters: PowerLogic ION 6200 in factory assembled enclosure PowerLogic 9761C6200 series. ION 7550 is acceptable where greater capabilities are necessary or desirable.
 - c. Mains and submeters for outdoor applications: PowerLogic ION 8600 with ethernet port and gateway in form 9S socket with automatic circuit closers, Millbank UC7237-XL or equal.
 4. Communications shall be PowerLogic ION protocol over RS-485. Main meters shall serve as gateways to the campus network.
- B. Current Sensing
1. Current transformers (CTs) shall be solid core with 5A secondary. Split core CTs and current sensors with voltage outputs shall not be used.
 2. CTs shall have ANSI/IEEE accuracy class ratings. CT accuracy classes shall be:
 - a. 1.2% or better for CTs rated 100A primary or less
 - b. 0.6% or better for CTs rated over 100A primary but less than 200A primary
 - c. 0.3% or better for CTs rated 200A primary or greater.
 - d. In all cases, CT circuits shall be designed such that the circuit impedance including impedances of conductors, terminals and metering equipment is within the rated burden of the associated CTs.
 3. CTs shall be installed in CT cabinets or pull boxes, or within main metering compartments in switchboards and switchgear.
 4. Current circuits shall include shorting terminal blocks at the CT locations as well as at the meter location.
- C. Voltage Sensing
1. For low voltage systems, voltage should be sensed directly without the use of potential transformers. Medium voltage system metering shall utilize voltage transformers.
 2. ANSI/IEEE accuracy class for voltage transformers shall be 0.3% with burden rating W or greater as determined based on metering equipment to be connected.
 3. Voltage sensing shall include finger-safe disconnecting means, current limiting fuses, and terminal blocks at each voltage sensing location.
- D. Wiring
1. Low voltage and current circuit wiring shall be 600V building wire, #12AWG minimum installed in conduit. #10AWG may be used to reduce circuit impedance.

- E. Communications Wiring
 - 1. Reference low voltage design standards at <http://gtlowvoltagestandards.gatech.edu/> .

3.01 Execution

- A. The contractor shall install a metering equipment, wiring and communications wiring. When metering equipment, wiring and communications wiring are complete and ready for use, notify Facilities - Design and Construction. Facilities - Design and Construction staff will program the meters.
- B. Install plastic laminate nameplates at each meter. Nameplates shall be as noted on the details and shall include the Georgia Tech meter number and the load served.
- C. Meter Numbers
 - 1. Meter numbers to be used will be included in the details provided.
 - 2. Meter numbering follows a campus-wide standard numbering scheme such that the meter number indicates the meter's location and its relationship to other meters at the site.

262726 – WIRING DEVICES

1.01 General

- A. Ground fault circuit interrupter (GFCI) requirements in addition to those of the NEC are contained in the Board of Regents Laboratory Design Guide. Work shall comply with the Board of Regents Laboratory Design Guide as well as the NEC.

2.01 Products

- A. Wiring devices shall be specification grade.
- B. Furnish 20A devices except where higher ratings are required.
- C. Receptacles and switches on emergency or standby power circuits shall be red.
- D. Receptacles controlled by automatic control systems shall be permanently marked by the manufacturer.

3.01 Execution

- A. Install wiring devices level and plumb, and at consistent heights.

END OF SECTION

SECTION 262816 – ENCLOSED CIRCUIT BREAKERS AND SWITCHES

1.01 General

(not used)

2.01 Products

- A. Safety switches shall be heavy duty type.
- B. Comply with NEMA 250 and NEMA KS-1

3.01 Execution

(not used)

END OF SECTION

262913 – ENCLOSED CONTROLLERS

1.01 General

- A. Scope: Low-voltage motor controllers - full-voltage manual and magnetic, reduced-voltage magnetic and electronic, and multispeed.
- B. Variable frequency drives are addressed in Section 262923.

2.01 Products

- A. Comply with NEMA ICS-2 and UL 508.
- B. Each magnetic or electronic controller shall be provided with a hand/off/auto switch and LED run light except where this requirement is in conflict with the project program or applicable codes.
- C. Electronic reduced-voltage controllers shall be equipped with run contactors to bypass the soft start electronics when the motor is running
- D. Electronic reduced-voltage controllers shall be provided with 50°C rating or shall be de-rated according to the manufacturer's instructions when applied in areas in which high ambient temperatures are likely. This includes all such controllers installed in the Holland and 10th St heating and cooling plants.
- E. Manual motor controllers shall be marked as required by NEC 430.109, or separate disconnecting means shall be provided.

3.01 Execution

- A. The Engineer shall evaluate the voltages present on the electrical system during starting of each motor or group of motors which can start simultaneously. Provide reduced voltage controllers as needed to limit starting voltage dip to acceptable levels.
- B. Variable frequency drives should not be used as motor controllers where constant full-speed operation is intended.
- C. Floor-mounted controllers shall be installed on raised concrete pads. Pads shall not be oversized and shall not encroach on electrical working space.
- D. Comply with NECA 230.

END OF SECTION

SECTION 262923 – VARIABLE FREQUENCY DRIVES

1.01 General

- A. Scope: Variable frequency drives rated 600V and less for the control of 3-phase induction motors.

2.01 Products

- A. Variable frequency motor controller with pulse-width-modulated inverter, factory built and tested in an enclosure with disconnecting means, overcurrent and overload protection. Listed and labeled as a unit.
- B. Provide bypass where required by other Divisions.
- C. Variable frequency drives installed in location that are likely to experience high ambient temperatures shall be fully rated for 50°C ambient temperature or shall be de-rated in accordance with the manufacturer's published instructions.
- D. All variable frequency drives to be installed in the Holland or 10th Street heating and cooling plants shall be fully rated for 50°C ambient temperature or shall be de-rated for 50°C ambient temperature in accordance with the manufacturer's published instructions
- E. A 3% line reactor shall be installed upstream of each variable frequency drive in order to ensure adequate source impedance. Filters shall not be substituted for this requirement.
- F. Related Products: Motors controlled by variable frequency drives shall be equipped with shaft grounding rings, Aegis SGR or equal.

3.01 Execution

- A. Variable frequency drives shall be located as close as practical to the driven motor.
- B. Variable frequency drives should be installed indoors whenever possible.
- C. Motor circuit conductors shall be XHHW, RHW or other XLPE or EPR containing insulations. Type THHN shall not be used.
- D. Where motor circuits are sized #1 AWG and larger, motor circuit conductors shall be continuous corrugated aluminum sheathed MC cable having three phase conductors and three grounding conductors symmetrically arranged within the sheath. MC cable shall be equal to Southwire HLX01XXH power cable.
- E. Harmonic distortion resulting from VFD application shall be within the limits prescribed by IEEE 519-1992; Recommended Practices and Requirements for Harmonic Control in Electrical Power Systems.
- F. Do not install un-necessary filters. Perform a harmonic analysis based on actual project conditions in order to determine the need for harmonic mitigating measures. Rules of thumb and other shortcut techniques are not acceptable.
- G. Coordinate variable frequency drive controls interface with the building control system and other Divisions.
- H. Start-up services shall be provided by the manufacturer's authorized technician.

END OF SECTION

SECTION 263213 – PACKAGED ENGINE GENERATORS

1.01 General

- A. Scope: Engine-generator sets used for emergency and standby power.
- B. Application:
 - 1. Engine-generator sets for emergency power are required for new construction and renovation projects over 50,000 GSF.
 - 2. All engine-generator sets installed for emergency and/or standby power on projects of any size shall comply with this Section.

2.01 Products

- A. Key features
 - 1. Natural gas fueled
 - 2. Water cooled with unit-mounted radiator
 - 3. 4-pole, 1800RPM alternator
 - 4. Isochronous governor
 - 5. Electronic voltage regulator
 - 6. Thermostatically-controlled water jacket heater
 - 7. Critical-grade exhaust silencer
- B. Engine generator sets shall be rated for operation at rated load at 40°C ambient temperature, minimum.
- C. Emissions:
 - 1. Comply with 40 CFR 60 Subpart JJJJ. Provide certification.
 - 2. Engine-generator sets with engines sized greater than 130 hp must be certified by the manufacturer as meeting a NO_x + HC emissions limit of 2.0 grams/bhp-hr or less.
 - 3. Engine-generator sets with engines sized less than 130 hp must be certified to meet a NO_x + HC emissions limit of 10 grams/bhp-hr or less.
- D. The engine-generator set manufacturer shall be represented locally. A full-time staffed service facility authorized by the engine-generator set manufacturer shall be located within the Atlanta metro area, or within 100 miles of the project site when projects are not located on the main campus.
- E. Enclosures for outdoor engine generators:
 - 1. Enclosures shall be products of the engine generator set manufacturer or as recommended by the engine generator manufacturer.
 - 2. Enclosures shall be locking, tamper resistant.
 - 3. Sheet steel or aluminum construction.
 - 4. Rodent-resistant. Include optional rodent screening where available.
 - 5. Walk-in enclosure shall have interior lights.

3.01 Execution

A. Location

1. Engine generator sets shall be installed in locations accessible to service vehicles for routine maintenance and shall be crane-accessible.
 - a. Where installed indoors or on roofs, engine generator set locations shall be accessible by service elevator. Stair access is not acceptable.
2. Exhaust discharge locations shall be suitably distant from building air intakes to prevent engine exhaust from entering buildings.
3. Installation locations shall be selected such that engine-generator set exercising during working hours will not cause objectionable noise levels in adjacent buildings.
4. Radiator air discharge and engine exhaust discharge shall be directed away from adjacent pedestrian areas, parking areas, HVAC equipment, gas equipment, and electrical equipment.
5. Provide at least 3 feet working space on all sides. Provide additional space as needed such that all doors and access panels can be fully opened without obstructions.
6. Slopes within working space shall be limited in order to provide a safe working environment.

B. Install a GFCI-protected receptacle within outdoor generator set enclosures.

C. Install closure plates on skid openings and other potential rodent entry points.

D. Gas Supply:

1. Georgia Tech campus gas (which utilizes an LP-air backup system) shall not be used. Install natural gas service only.
2. Where projects utilize the Georgia Tech mixed gas system for other gas-fueled equipment, provide a separate Atlanta Gas Light natural gas service for engine generator sets.
3. Coordinate gas meter and regulator types, capacities, and gas piping design to ensure adequate gas pressure at the engine generator set inlet during transient events such as step load acceptance.

E. Testing:

1. Following code-required load testing, each engine generator shall be operated at full load such that the total duration of load testing plus additional full load run time is eight hours.
2. Testing shall be documented and reports shall be delivered with the O&M data.

END OF SECTION

263600 – AUTOMATIC TRANSFER SWITCHES

1.01 General

- A. Scope: Automatic transfer switches used in emergency and standby power systems.

2.01 Products

- A. Automatic transfer switches for emergency and standby service shall be closed transition except as follows.
 - 1. Transfer switches in facilities served directly by Georgia Power Co., transfer switches shall comply with Georgia Power Co. requirements including reverse power protection as required. Where reverse power protection is required, open transition transfer switches may be proposed as an alternative. The use of open transition transfer switches is subject to Owner approval.
- B. Transfer switches used in critical applications shall be bypass-isolation type.
- C. Automatic transfer switches shall include programmable exerciser clocks capable of controlling weekly exercise periods and selectable load/no-load exercising.
- D. Where generator sets are not adequate to supply all connected loads simultaneously, automatic transfer switches shall include load shedding controls as needed in order to meet NEC requirements for selective shedding of non-emergency loads.
- E. Automatic transfer switches supplying elevators shall be equipped for interface and coordination with elevator controls.

3.01 Execution

- A. Automatic transfer switches should be located indoors wherever practical.
- B. Program exerciser clocks as directed by the Owner.

END OF SECTION

265100 – INTERIOR LIGHTING

1.01 General

- A. Scope
 - 1. Interior and building-mounted lighting fixtures
 - 2. Not included: Pole-mounted and parking garage lighting is addressed in Section 265600.
- B. Lighting Design Criteria
 - 1. Indoor fluorescent fixtures shall utilize T5 fluorescent lamps wherever possible.
 - 2. T-8 lamps and compact fluorescent lamps are acceptable where products utilizing T5 lamps are not commercially available for the fixture types required.
 - 3. Coordinate lamp type with area lighting controls to verify ballast compatibility with lighting control technologies
 - 4. Self-ballasted compact fluorescent lamps are not acceptable
 - 5. The use of LED lighting fixtures is highly desirable where suitable products are available. Color temperatures for general lighting shall match that specified for fluorescent lighting. Indoor lighting levels shall be as recommended by the Illuminating Engineering Society of North America, IESNA
 - 6. Local standby generators are the preferred method for powering emergency egress lighting.
 - 7. Provide battery backup ballasts and/or battery powered emergency lighting fixtures where an engine-generator set is not included in the project.
 - 8. Where one or more engine-generator sets are included in the project, emergency egress lighting shall be powered by the emergency power system.

2.01 Products

- A. All indoor fluorescent fixtures shall be specification grade.
- B. Fluorescent fixtures shall be equipped with high frequency electronic ballasts.
- C. Exit signage shall be illuminated by diffuse LEDs.
 - 1. Provide green LED signs for all new work and complete renovations.
 - 2. Provide red LED signs only where existing signage is to remain and is red.

3.01 Execution

- A. Fixtures shall be supported independently of ceiling grids. Provide at least two supports at diagonally opposite corners of each fixture. Supports shall be attached directly to the structure above

END OF SECTION

265600 – EXTERIOR LIGHTING

1.01 General

A. Scope

1. Included in this Section: LED lighting fixtures for
 - a. Streets, including service drives and similar applications
 - b. Surface parking lots
 - c. Pedestrian walkways and bikeways
 - d. Parking garage interior and top level parking areas
2. Not Included in this Section:
 - a. Building-mounted exterior fixtures except where used for applications noted above.
 - b. Interior fixtures except as noted above.
 - c. Accent, landscape and other exterior fixtures used for purposes other than those listed above.

B. Lighting Design Criteria

1. Streets, walkways and surface parking areas:
 - a. Illuminance levels: Comply with IESNA G-1-03 and not less than 2fc horizontal average, maintained. Average to minimum uniformity ratios for pedestrian walkways shall not exceed 4:1 horizontal. The area within 10' (min.) on each side of pedestrian walkways shall be illuminated at one third of the pedestrian walkway illuminance or greater.
2. Parking garage lighting:
 - a. Illuminance levels: Comply with IESNA G-1-03, but not less than 6fc average horizontal, maintained and no greater than 4:1 average to minimum uniformity. After approval of fixture submittals, the engineer shall calculate a high-level dimming setpoint such that the system can be tuned to the required average light level. Calculation shall include appropriate light-loss factors. The intent is reduce energy usage by operating the system at less than 100% power while maintaining the target illuminance criteria.

2.01 Products

A. Campus Standard Fixtures

1. Campus standard street, walkway, parking lot and parking garage fixtures shall be LED.
2. General Requirements for LED Fixtures:
 - a. Cast aluminum housings with integral thermal management system and corrosion resistant powder coat finish.
 - b. UL listed and labeled for wet locations.
 - c. Ingress protection rating of IP65 or higher.
 - d. RoHS compliant.

- e. 4000°K color temperature.
 - f. CRI 70, minimum.
 - g. Comply with ANSI C78.377A
 - h. Test report and .ies photometric file available for each fixture configuration to be used. Testing in accordance with IESNA LM-79 by a nationally recognized testing laboratory.
 - i. Lumen maintenance data determined in accordance with IESNA LM-80 and IESNA TM-21.
 - j. Fixtures shall appear in the Design Lights Consortium qualified products list.
 - k. Electronic drivers with thermal protection, short circuit protection and overload protection.
 - l. Surge protection meeting Category C per ANSI C62.41.2.
 - m. Power factor: 0.9 or higher. THD: less than 20%.
 - n. Fixture manufacturer shall have been in the business of manufacturing LED fixtures for at least 5 years.
 - o. Fixture warranty shall be 5 years, minimum.
 - p. Furnish fixtures using LED chips by a manufacturer which has been in the business of producing LED chips for lighting applications for at least 3 years.
3. Additional Requirements for Street and Surface Parking Area Fixtures:
- a. Full cutoff
 - b. Traditional shoebox form, arm-mounted on square steel poles. Fixture size and appearance shall be similar to traditional HID shoebox fixtures.
 - c. Dark bronze finish.
 - d. Minimum lumen maintenance: 0.9 at 50,000 hours at 25°C.
 - e. Expected fixture life: 100,000 hours, minimum
 - f. Nominal 30' mounting height above grade.
 - g. Street lighting fixtures: **Lithonia CSX1 LED 60C 700 40K SPA DDBXD** or equal. Light distribution type shall be selected by the engineer as needed for each application.
 - h. Parking lot lighting fixtures: **Lithonia CSX1 LED 60C 700 40K SPA DMG DDBXD** or equal. Light distribution type shall be selected by the engineer as needed for each application.
 - i. Any proposed equivalent fixtures shall be submitted to the Owner for approval prior to bid. Equivalency will be judged on appearance and on compliance with this Section.
 - j. Poles: 5" square steel, non-tapered, 30' height with anchor base, handhole, base cover and dark bronze powder-coat finish. Equal to Lithonia SSS 30 DDB.

4. Additional Requirements for Pedestrian Scale Fixtures:
 - a. The campus pedestrian-scale fixture is Holophane Utility-Series Arlington full cutoff, 70W, dark bronze: **Holophane AUCL2 053HO 40K AS BZ L5 S AO H PSC**.

Notes:
 1. IES type V distribution is preferred. Where other distributions are necessary, substitute the appropriate distribution in place of “L5”. For all distributions other than L5, indicate required aiming on the plans.
 2. Where individual photocontrol is required, substitute the appropriate photocontrol option in place of “PSC”.
 3. Contact Facilities Design and Construction before specifying fixtures for 480V applications.
 - a. The campus pedestrian-scale fixture pole is Holophane Wadsworth series with 19” base, 5” straight fluted shaft, 10’ height: **Holophane WD A 10 F5J 19 P07 ABG BZ**.
 - b. Substitution of fixtures and/or poles is not permitted.
 - c. Set internal dimming control at 5.
 5. Additional Requirements for Parking Garage Fixtures:
 - a. Minimum lumen maintenance: 0.95 at 50,000 hours at 25°C.
 - b. Expected fixture life: 100,000 hours, minimum
 - c. 0-10V dimming, capable of dimming to 10% power or lower.
- B. Controls
1. Street and walkways lighting control:
 - a. Photocell controlled as a group. Individual photocell control should be avoided.
 2. Parking garage and surface parking lot lighting control:
 - a. Control system shall include multiple dimming zones with occupancy sensors. In addition to occupancy-based dimming control, perimeter zones shall include daylighting control. In addition to occupancy-based dimming control, top-level and surface parking area fixtures shall also include dusk to dawn control.
 - b. The system shall include ethernet gateways, wireless fixture control modules, repeaters as needed, PIR motion sensors, daylight sensors and photocells.
 - c. Remotely accessible management software with multi-level password secured access shall permit remote commissioning of devices, creating and editing control groups and schedules, setting and changing dimming level for high and low level setpoints, setting and changing motion sensor time delay parameters, temporary override capability, historical energy logging and data logging, and data export to Excel or.csv. Software shall

be locally installed, Windows 7 64-bit compatible, and shall not require a subscription fee.

- d. Dimming shall be 0-10V, adjustable in 0.1V increments.
- e. System hardware and components shall be suitable for outdoor installation and use and shall be UL listed. Wireless components shall comply with FCC regulations.
- f. Where fixture controllers and/or motion sensors are installed inside fixtures, such components shall be factory-installed and shall not compromise the fixture warranty.
- g. Controls shall be compatible with the Owner's existing control system. Contact the Owner for additional details regarding parking garage lighting controls.
- h. Full commissioning of the controls system shall be included as part of the construction contract. The commissioning agent shall be a qualified, authorized representative of the controls manufacturer. Commissioning shall be performed in consultation with the Owner.

C. Pole Foundations

- 1. All pole foundations shall be 24" diameter round precast concrete with 1" chamfer at the top. Foundations shall be designed by a licensed engineer. Pole foundations shall be fabricated by a precast concrete manufacturer whose regular business includes manufacturing of precast pole foundations.

3.01 Execution

A. Pole Foundations:

- 1. Anchor bolt pattern shall be centered in the foundation such that when installed, the pole is centered on the foundation.
- 2. All conduits and wiring shall be concealed inside the foundation and within the pole.
- 3. Street light and parking lot pole foundations shall be oriented such that the flat sides of the pole are parallel and perpendicular to the adjacent curb.
- 4. Use double nuts for street light poles and adjust such that poles are plumb. Install the pole manufacturer's matching anchor base cover to conceal anchor bolts and nuts.
- 5. Set pedestrian-scale poles tight to foundations. Do not use double nuts. Shim pedestrian- scale poles plumb and grout any remaining void with non-shrink grout.
- 6. Pole foundation projections above grade shall be the minimum necessary to prevent water, silt and debris from entering or accumulating against pole bases and shall be coordinated with the elevation of any adjacent sidewalks or similar surfaces. Foundations within sidewalks and similar hard-surfaced areas shall be set such that the bottom of the chamfer meets the sidewalk. In sloped areas, this applies to the uphill side.
- 7. Street and parking lot light pole foundations in vehicular traffic areas shall extend 30" above grade to prevent vehicles from contacting poles. Pedestrian poles shall not be placed in vehicular traffic areas.

8. See illustrations at the end of this Section.
- B. Parking Garage Lighting Controls:
1. Full commissioning of the controls system shall be included as part of the construction contract. The commissioning agent shall be a qualified, authorized representative of the controls manufacturer. Commissioning shall be performed in consultation with the Owner.
- C. Design
1. Spacing between street and walkway fixtures shall be determined by the engineer except as required by the Landscape Design Criteria. Lighting shall meet the specified lighting design criteria.
 2. For all large areas and whenever possible, use staggered circuits in order to minimize the loss of light in the event of failure of one circuit.
 3. For pole-mounted fixtures, install fuses in pole base.

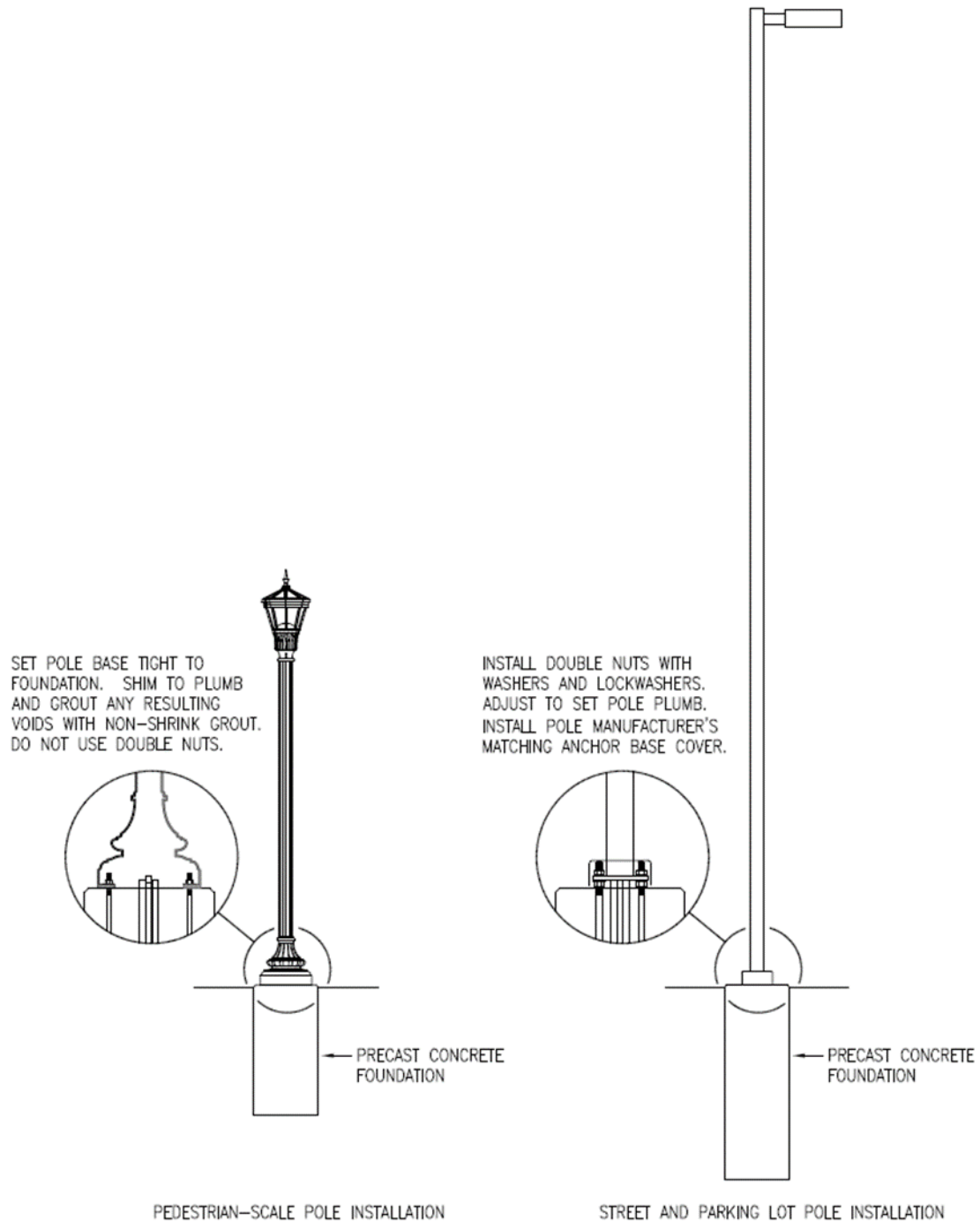

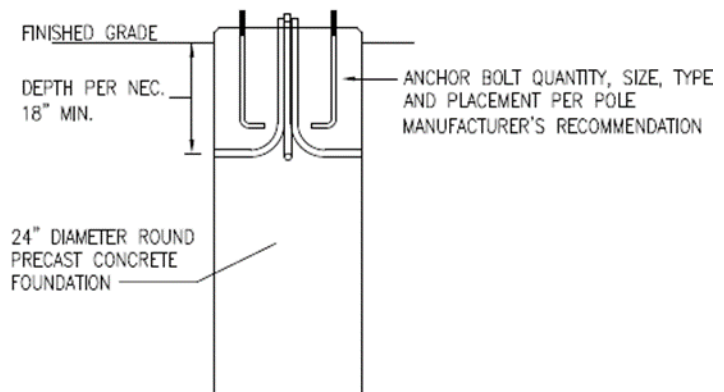
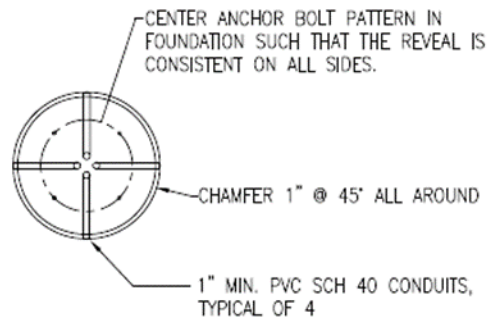
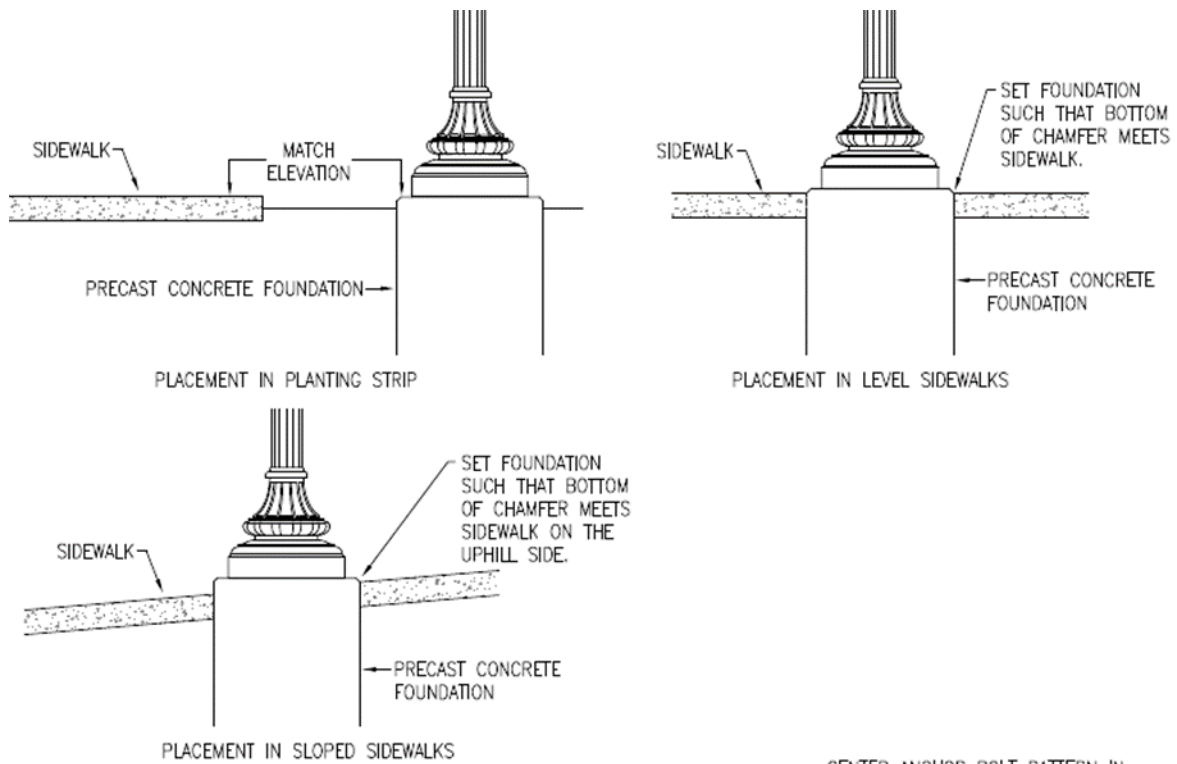

GENERAL FOUNDATION REQUIREMENTS FOR PEDESTRIAN-SCALE, STREET LIGHT, AND PARKING LOT LIGHT POLES

A. Legacy Fixtures

1. The following fixtures are retired standards. They shall not be specified or installed except where specifically directed by the Georgia Tech Project Manager.
 - a. Street and parking area fixture: Full cutoff shoebox style equal to General Electric Decashield 400, dark bronze finish, 250W or 400W HPS lamp, 30' mounting height. IES type III or other optic as selected by the engineer for each application. Install on 5" square steel pole, 30' height, with dark bronze finish equal to Lithonia SSS 30 DDB.
 - b. Pedestrian-scale fixture, traditional: Holophane Utility-Series Arlington full cutoff with medium-base 100W HPS lamp and dark bronze finish: Holophane ARU 10DHP MT Z C3 S. Engineer shall select C3 or C5 optic as needed for each application. Install with Holophane Wadsworth pole, 19" base, 5" straight fluted shaft, 10' height: Holophane WD A 10 F5J 19 P07 ABG BZ.
 - c. Pedestrian-scale fixture, contemporary: Intrigue Large Eurotech full cutoff with 100W HPS lamp, dome top and silver finish: Intrigue LET PT 100HPS D TY5 SIL. Install with Intrigue pole, 4" round straight shaft and 10' height: Intrigue PA1 S 10 T 4.

END OF SECTION

270500 COMMON WORK RESULTS FOR COMMUNICATIONS

1.01 General:

- A. Telecommunications is to be considered as a prime utility with the same status as electrical power, water and sewer in new construction and renovation projects. The Using Agency, when developing its project program budget, is to include telecommunications infrastructure (by Architects and Engineers) and basic electronics budgets.
- B. The development of design and construction documents for telecommunications infrastructure should be included in the full scope project construction documents as prepared by the design professionals for the project.
- C. The following are minimum design guide lines for use in all state facilities.

1.02 Programmatic Design Stage

- A. The design professional will meet with the Using Agency along with a IT Project Manager representative from the Georgia Institute of Technology - Office of Information Technology (OIT), to determine the following site specific issues:
- B. Using Agency's preferred data and telephone topology for the wiring infrastructure and electronic methodology.
- C. Develop a preliminary budget for site pathways and associated enclosures (for both Using Agency's needs and public utilities) and Using Agency's interbuilding cabling infrastructure as part of the project construction cost.
- D. Develop a preliminary budget for intrabuilding cabling infrastructure for data, telephone and video (including backbone cables) as part of the project construction cost.
- E. Develop a preliminary budget for the data network electronics (switches, routers, etc.) necessary to meet the minimum requirements. The data electronics budget shall be included as a sub line item in the loose equipment budget of the project budget.
- F. Develop a preliminary budget for the wireless network electronics necessary to meet the minimum requirements. The wireless electronics budget shall be included as a sub line item in the loose equipment budget of the project budget.
- G. Develop a preliminary budget for telephone sets and installation of telephone dial tone to meet the needs of the using agency and building /fire /life safety and security /alarm /control circuits. The voice equipment budget shall be included as a subline item in the loose equipment budget of the project budget.

1.03 Preliminary Design Stage

- A. Site specific requirements for local telephone service routes to site, service and backbone cable, raceway requirements and data service for the site.
- B. Establish any Using Agency deviations from the telecommunications minimum requirements.

1.04 Fundamentals of Design

- A. In all cases of new construction and renovation, projects shall include a data/telephone network connection in each classroom, office (selected offices includes video), laboratory, conference room, and dorm room. Video distribution system shall be included to service classrooms, lecture halls and auditoriums when required by the Using Agency.
- B. The design for these networks should be complete enough to provide fundamental data network communications to each port.
- C. All of the equipment selected and designed by the Using Agency shall meet or exceed national accepted standards of IEEE 802.3 or other national standards. The Using Agency may enhance the telecommunications requirements for their project, but may not deviate below the minimum requirements as specified by this document.
- D. In the case of renovations, it is recommended the removal of existing communications cables be reviewed, if appropriate.

1.05 General Site Pathways and Infrastructure

- A. Provide pathways for Using Agency and public utilities to building entrance room. A minimum of (2) 4" and (4) 2" concrete encased ducts shall be installed for building services. Coordinate with Using Agency for connection location to existing OSP infrastructure. Depending on function of the building, the number and size of ducts will change upward. Refer to the following list for recommended minimum entrance conduits based on building use/occupancy:
 - 1. Small Residential or Small Admin: (2) 4" & (4) 2" concrete encased ducts
 - 2. Large Residential ducts: (4) 4" & (4) 2" concrete encased
 - 3. Large Admin or Small Academic: (4) 4" & (6) 2" concrete encased ducts
 - 4. Large Academic or Small Research: (6) 4" & (6) 2" concrete encased ducts
 - 5. Large Research: (6) 4" & (8) 2" concrete encased ducts
- B. 4" duct with (4) 1" corrugated innerducts (w/ pull tape) can be substituted for 2" ducts on a (1) 4" duct with innerducts per (2) 2" ducts (round up).
- C. For interbuilding fiber (data services), in a campus environment, run a minimum of 12-strand single-mode fiber optic cables from the closest interconnect location to building Entrance Facility (EF) / Equipment Room (ER). In some cases, a multi-mode fiber optic cable (62.5/125um or 50/125um OM3) might be required. Coordinate with Using Agency for location and path to closest interconnect location. Interbuilding fiber optic cables shall be of loose tube, all-dielectric construction. Refer to the following list for recommended minimum fiber counts based on building use/occupancy:
 - 1. Small Residential or Small Admin: 12sm
 - 2. Large Residential: 24sm
 - 3. Large Admin or Small Academic: 24sm
 - 4. Large Academic or Small Research: 36sm
 - 5. Large Research: 48sm

- D. 50/125um OM3 laser optimized, multi-mode fiber should be considered for new campuses, for campuses with 50/125um OM3 fiber already installed, and/or interbuilding fiber lengths less than 300 meters.

1. Enhanced Multi-mode Fiber (50/125um OM3) - laser optimized:

<u>Wavelengths</u>	<u>850nm</u>	<u>1300nm</u>
Attenuation (max)	3.5dB/km	1.5 dB/km
Bandwidth (min)	2000 MHZ/km	500 MHZ/km

- a. Guaranteed 10 Gigabyte Ethernet distance 300m

2. Multi-mode Fiber (62.5/125um):

<u>Wavelengths</u>	<u>850nm</u>	<u>1300nm</u>
Attenuation (max)	3.5dB/km	115 dB/km
Bandwidth (min)	200 MHZ/km	500 Z/km

3. Single-mode Fiber:

<u>Wavelengths</u>	<u>1310nm</u>	<u>1500nm</u>
Attenuation (max)	0.45dB/km	0.35 dB/km
Bandwidth (min)	N/A	N/A

- E. All interbuilding fiber optic cables shall be homerun from building EF / ER to interconnect location.
- F. See section 12.01 EF / ER and TR Fiber Optic Components for termination hardware for fiber cables.
- G. For buildings which receive their data network services via telephone services contact Service Provider for the site specific data network to ascertain which carrier and local exchange will be involved and their preferred routing into the building project.
- H. The Using Agency will provide the basic electronics specifications to connect the building to the campus network or agency network. The electronic device will, in most cases, be a router.
- I. Contact Service Provider for the site specific telephone service routing and space requirements for the Entrance Facility (EF) / Equipment Room (ER) and Telecommunication Rooms (TRs) for the building.

1.06 Entrance Facility (EF) And Equipment Room (ER)

- A. Create a central entrance room for all communications for a building. This space will be known as the Entrance Facility (EF) / Equipment Room (ER). Locate the telephone and data entrance ducts, cables, protectors, etc. in this location. The main building data electronic equipment will be located in this space.
- B. Reference ANSI / TIA / EIA / 569B for recommended sizes. A minimum room of 150 sq.ft. size (10' x 15') with a single 3'-0" door opening outward is required. Locate EF / ER so that door opens to common area (ie: hallway). Do NOT locate EF / ER so that access must be gained through another space to get to EF / ER.
- C. Provide a minimum of (9) nine 20A, 120v, isolated ground, duplex receptacles (provide receptacles every 4'-0" o.c.) on a minimum of (3) three dedicated 20A circuits and (2) dedicated 20A, 240v, grounded, locking receptacles (L6-20R) per EF / ER. If EF / ER has equipment racks, provide (2) dedicated 20A, 240v, grounded, locking receptacles (L6-20R) and (1) dedicated 20A, 120v, isolated ground, quadruplex mounted to equipment rack designated for building network equipment and building voice equipment respectively. If available, (1) L6- 20R shall be on normal building power and (1) L6-20R shall be on generator back-up power and the (1) quadruplex shall be on generator back-up power. Verify / coordinate exact power requirements with Georgia Tech – OIT for exact equipment being supplied.
- D. Coordinate with Service Provider for EF / ER specific telephone space, grounding, power (if applicable), requirements.
- E. EF / ER shall have sleeves / conduits to first level TRs on the floor(s) above. Provide (4) 4" sleeves / conduits **plus** (1) 4" sleeve / conduit for every (2) two floors above EF / ER.
- F. See Mechanical section for HVAC requirements for Entrance Facility / Equipment Room.

1.07 Telecommunication Room (TR)

- A. If the building has multiple floors, telecommunication rooms are recommended on each floor. Because the distance from the proposed telecommunication room shall not be over 250 feet to any workstation location, multiple TRs may be required (on the same floor). TRs should be located near the center of the building and vertically aligned whenever possible.
- B. Reference ANSI / TIA / EIA / 569B for recommended sizes. A minimum room of 10'x11' size with a single 3'-0" door opening outward is required for each 10,000 square feet of floor area. Locate TR so that door opens to common area (ie: hallway). Do NOT locate TR so that access must be obtained, through another space to get to TR.
- C. Provide a minimum of (6) six 20A, 120v, isolated ground, duplex receptacles (provide receptacles every 4'-0" o.c.) on a minimum of (2) two dedicated 20A circuits per TR. If TR has equipment racks, provide (2) dedicated 20A, 240v, grounded, locking receptacles (L6-20R) and (1) dedicated 20A, 120v, isolated ground, quadruplex mounted to equipment rack designated for network equipment and voice equipment respectively. If available, (1) L6-20R shall be on normal building power and (1) L6-20R shall be on generator back-up power and the (1) quadruplex shall be on generator back-up power. Verify / coordinate exact power requirements with Georgia Tech – OIT for exact equipment being supplied.

- D. Telecommunication Rooms shall have sleeves / conduits to TR on the floor above. Provide (4) 4" sleeves / conduits **plus** (1) 4" sleeve / conduit for every (2) two floors above TR in question.
- E. See Mechanical section for HVAC requirements for Telecommunication Rooms.

1.08 Building Fiber Backbone

A. For intrabuilding fiber backbone (data services), run a minimum of 12-strand multi-mode (50/125um OM3 laser optimized) and 12-strand single-mode fiber optic cables from the EF / ER to each TR (62.5/125um may be used in addition to 50/125um fiber for support of legacy systems). **Each fiber optic backbone cable shall be homerun from TR to EF / ER.** Intrabuilding fiber optic cables shall be of tight buffered, plenum-rated construction. Refer to the following list for recommended minimum fiber counts based on building use/occupancy:

1. Residential or Small Admin 12mm (50um)/12sm
2. Large Admin or Small Academic 24mm (50um)/24sm
3. Large Academic or Small Research 36mm (50um)/36sm
4. Large Research 48mm (50um)/48sm
5. **Enhanced Multi-mode Fiber (50/125um OM3) - laser optimized:**

<u>Wavelengths</u>	<u>850nm</u>	<u>1300nm</u>
Attenuation (max)	3.5dB/km	1.5 dB/km
Bandwidth (min)	2000 MHZ-km	500 MHZ-km

- a) Guaranteed 10Gigabit Ethernet distance 300m
- b) 50um multi-mode fiber optic cables shall have an AQUA outer jacket color.

6. **Multi-mode Fiber (62.5/125um) - if required:**

<u>Wavelengths</u>	<u>850nm</u>	<u>1300nm</u>
Attenuation (max)	3.5dB/km	1.1 dB/km
Bandwidth (min)	200 MHZ-km	500 MHZ-km

- a) 62.5um multi-mode fiber optic cables shall have an ORANGE outer jacket color.

7. **Single-mode Fiber:**

<u>Wavelengths</u>	<u>1310nm</u>	<u>1500nm</u>
Attenuation (max)	1.0 dB/km	0.75 dB/km
Bandwidth (min)	N/A	N/A

- a) Single-mode fiber optic cables shall have a YELLOW outer jacket color.

- A. All intrabuilding fiber optic cables shall be plenum rated.
- B. See section 12.01 EF / ER and TR Fiber Optic Components for termination hardware for fiber cables.

1.09 Building Voice Backbone

- A. For intrabuilding voice backbone, run a minimum of (1) one 100-pair category 3 UTP cable from the EF / ER to each TR. **Each voice backbone cable shall be homerun from TR to EF / ER.** Intrabuilding voice cables shall be plenum-rated construction.
- B. Intrabuilding voice backbone cables shall be sized as to cross connect (1) one pair of each 4- pair, UTP, voice station cable (served out of given TR) plus 25% (future). Voice backbone cables shall be in multiples of 50-pair (round up). Multiple cables may be required for calculated pair count
- C. See section 13.01 EF / ER and TR Voice Components for termination hardware for voice cables.

1.10 Building Video Coax (Catv) Backbone

- A. For intrabuilding video coax backbone (CATV services), run a minimum .500, 75 ohm distribution cable from the EF / ER through each TR. Coil 30' of .500 distribution cable in each TR. Intrabuilding video cables shall be of plenum-rated construction.
- B. See section 15.01 EF / ER and TR Video Coax (CATV) Components for termination hardware for coax cables.

1.11 Building Telecommunications Ground Backbone

- A. For intrabuilding telecommunication ground backbone, run a minimum #6Cu (#3/0 Cu recommended) Telecommunications Bonding Backbone (TBB) ground wire from the EF / ER through each TR. The TBB shall be a continuous conductor from the TMGB to the farthest TGB. Intermediate TGBs shall be spliced to the TBB with a short piece of bonding conductor.
- B. In the EF / ER, provide a Telecommunications Main Grounding Busbar (TMGB). TMGB shall be a minimum size of 4" x 20" x 0.25" copper. TBB shall be connected to ground bus bar.
- C. In each TR, provide a Telecommunications Grounding Busbar (TGB). TGB shall be a minimum size of 2" x 10" x 0.25" copper. TBB shall be connected to ground bus bar.

1.12 EF / ER and TR Fiber Optic Components

- A. Interbuilding (OSP campus distribution) and intrabuilding (interior backbone) fiber optic cables shall be terminated in wall-mount termination cabinets or rack-mount termination shelves. Adapter panels shall be provided for all terminated fiber. Fusion spliced pigtails shall require splice cabinets / shelves for splice trays.
- B. Multi-mode 62.5/125um fiber optic cables shall be terminated with ceramic tip ST type connectors.
- C. Multi-mode 50/125um fiber optic cables shall be terminated with ceramic tip LC type connectors.
- D. Single-mode fiber optic cables shall be terminated by FUSION splicing ceramic tip ultra PC polished SC pigtails or fusion splice-on SC UPC connectors. The last (2) strands of the OSP single-mode fiber optic cable shall be terminated with SC APC connectors
- E. All fan-outs, splice trays, and associated components shall be required for a complete and acceptable fiber optic system.

1.13 EF / ER and TR Voice Components

- A. Intrabuilding (interior backbone) voice UTP cables shall be terminated on wall-mount 100-pair (or 300-pair) 110 type termination blocks.
- B. Voice station 4-pair UTP cables shall be terminated on wall-mount 100-pair (100-pair only) 110 type termination blocks. All 4-pairs shall be terminated.
- C. The punch down sequence shall be the ANSI / TIA / EIA / 568B standard.
- D. Wire troughs shall be installed above and below each 100-pair 110 type termination block.
- E. All label strips, mounting hardware, and associated components shall be required for a complete and acceptable voice system.

1.14 EF / ER and TR Data Components

- A. Data station 4-pair UTP cables shall be terminated on 48-port, high density, 568B patch panels.
- B. Mount patch panels on 19" hinged, wall-mount brackets, 19" x length required x depth required, wall mount equipment racks, or 19" x 7' floor mount equipment racks. If floor mount equipment racks are used, 10" wide, double sided, vertical wire management shall be provided between each rack and 6" wide, double sided, vertical wire management on the ends of the rack line up. Floor mount equipment racks are recommended.
- C. Provide 2RU, horizontal wire management panels above and below each 48-port patch panel.
- D. Provide (1) 7' and (1) 14' cat5e stranded patch cord per data port in TR.
- E. All label strips, mounting hardware, and associated components shall be required for a complete and acceptable data system.

1.15 EF / ER and TR Video Coax (CATV) Components

- A. Provide video passive and active electronics necessary to have a complete and operational CATV system. Provide distribution amp in the EF / ER for the CATV system. CATV backbone distribution cable shall be neatly coiled using metal D-rings.
- B. CATV taps shall be sized and installed as one tap port for every CATV station port. All CATV station cables shall be homerun. Splitters shall **NOT** be used on tap station output or on station cables.
- C. Provide (1) 6' CATV RG-6 quadshield patch cord per CATV port in TR. Connect CATV patch cord from tap to terminated CATV drop.
- D. Video station coax cables (RG-6 quadshield or RG-11 quadshield) shall be terminated on F- connector bulkhead patch panels. 6" minimum depth wall mount brackets shall be used for video bulkhead panels.
- E. All connectors, taps, couplers, mounting hardware, and associated components shall be required for a complete and acceptable CATV video system **where a signal level of 12 dBmV (+/- 3dBmV) @ 750 MHZ at the tap and a minimum signal level of 0 dBmV at the wall outlet will be assured.**

1.16 Building Station Cabling

- A. The primary method of wiring will be to install from the port to the nearest telecommunications room. The design distance SHALL NOT BE GREATER THAN 250 FEET. All cabling shall be tested against the EIA/TIA category standards. **ALL data, voice, and coax (CATV) shall be homerun. Splitting, splicing, or daisy chaining of cabling is NOT permitted.**
- B. Data station cables shall be CAT-5e, 4-pair, UTP, plenum rated. Data cables shall have a BLUE outer jacket color.
- C. Data cables for IP security cameras shall be CAT-6, 4-pair, UTP, plenum rated. Data cables for cameras shall have a BLUE outer jacket color.
- D. Data cables for Dangerous Gas Monitoring System (DGMS) shall be CAT-5e, 4-pair, UTP, plenum rated. Data cables for DGMS shall have a RED outer jacket color.
- E. Voice station cables shall be CAT-5e, 4-pair, UTP, plenum rated. Voice cables shall have a WHITE outer jacket color.
- F. Video coax (CATV) station cables shall be RG6 quadshield (RG11quadshield for runs between 200 and 300 feet), plenum rated.
- G. Fiber station cables shall be 2-strand, 50/125um **laser optimized**, multi-mode, round cordage, plenum rated. 50um fiber optic cables shall have an AQUA outer jacket color.
- H. All cabling shall be tested against the EIA / TIA category standards and test reports shall be provided to the Using Agency and/or, Service Provider.
- I. Do not locate cables near equipment such as light ballasts and power transformers which may emit electromagnetic interferences.
- J. Provide a cable support system in accordance with EIA / TIA / 569A. Do not allow the cable to be laid on ceilings or strung through bar joist or rafters.

1.17 Telecommunication Outlet Components / Configurations

- A. For station workstation outlets provide a 2-gang box, plaster ring (either 1-gang or 2-gang), and (either 1 or 2) 1" conduit stub (s). Each station box shall have a dedicated conduit to accessible location. Daisy chaining of conduits (so that cables have to pull-thru another station box) is **NOT** permitted.
- B. 1-gang faceplates shall be 6-port type and be able to accept 8-pin modular connectors, F- connectors, and LC, SC, and ST fiber connectors. Blanks shall be installed in unused spaces.
- C. 2-gang faceplates shall be 12-port type and be able to accept 8-pin modular connectors, F- connectors, and LC, SC, and ST fiber connectors. Blanks shall be installed in unused spaces.
- D. Floor mounted poke-thrus and/or floor boxes shall be able to accept 8-pin modular connectors, F-connectors, and LC, SC and ST fiber connectors. Fiber connectors are **NOT** recommended to be installed in poke-thrus. Blanks shall be installed in unused spaces. Coordinate with A/V multimedia requirements (floor boxes are commonly shared with A/V connectors / components).

- E. Refer to the following list for recommended minimum cable set configurations based on room use/occupancy:
1. Office: (2) two outlets on opposite walls with (2) cat5e data and (1) cat5e voice per outlet per (normal 80sqft - 120sqft) office. Larger offices will have additional (2) cat5e data and (1) cat5e voice outlets for every 60sqft over 100sqft. In addition, select offices (Deans, Directors, Managers) will have (1) RG-6 (or RG-11) quadshield CATV cable.
 2. Cubicle / Workstation: (1) one outlet (mounted in baseplate) with (2) cat5e data and (1) cat5e voice per cubicle. Size pathways to cubicle to support cables to be installed **plus** 50% future space. Provide (1) extra pathway (sized as above) for future cabling needs.
 3. Classroom: (1) one outlet consisting of (2) cat5e data, (1) RG-6 (or RG-11) quadshield CATV, AND (1) cat5e voice wall-mount telephone. Locate both outlets at front of room. See multimedia section for additional data requirements to support A/V equipment suite.
 4. Enhanced Classroom (Select classrooms): (1) one outlet consisting of (2) cat5e data, (1) RG-6 (or RG-11) quadshield CATV, (1) cat5e voice wall-mount telephone (located by entrance door), AND (1) one (1) cat5e data outlet for each student seat. See multimedia section for additional data requirements to support A/V equipment suite.
 5. Laboratory: (1) cat5e voice wall-mount telephone (located by entrance door), AND (1) one outlet with (2) cat5e data outlet for every 6 feet of wall and/or free standing lab benches. Locate data ports to avoid fumehoods, sinks, etc...
 6. Conference Room: (1) one outlet consisting of (2) cat5e data, (1) cat5e voice, and (1) RG-6 (or RG-11) quadshield CATV, AND (1) one outlet with (2) cat5e data and (1) cat5e voice outlet for each 10 feet of wall. See multimedia section for additional data requirements to support A/V equipment suite.
 7. Computer Lab: (1) one outlet consisting of (2) cat5e data, (1) cat5e voice, and (1) RG-6 (or RG-11) quadshield CATV,; (1) cat5e data per computer workstation; AND (1) cat5e data per network printer. See multimedia section for additional data requirements to support A/V equipment suite.
 8. Wireless Access Point: (1) cat5e data (w/ 30' coil) installed at 35' intervals (grid) for future wireless locations. Since the intervals may vary, due to construction materials, space layout, and building size, coordinate with Using Agency for placement of these cable sets. Terminate cable with cat5e jack and test per specifications.
 9. IP CCTV Camera Location: (1) cat6 data (w/ 30'coil) installed at proposed camera location. Terminate cable with cat6 plug and test per specifications. Cat6 cable for exterior CCTV camera can be terminated on cat5e hardware.

- F. Additional cable requirements will vary with each project. The Professional Design Team shall interview the tenants for any additional networking requirements. Some, but not all, additional requirements are listed below:
1. Fire Alarm Panel - (2) cat5e voice.
 2. Energy Management System Controller - (2) cat5e data and (1) cat5e voice.
 3. Door Control System - (2) cat5e data and (1) cat5e voice.
 4. Intrusion / Burglar Alarm Panel – (1) cat5e data and (1) cat5e voice.
 5. Equipment Tamper Alarm Panel – (1) cat5e data and (1) cat5e voice.
 6. Chiller Controller - (2) cat5e data and (1) cat5e voice.
 7. Elevator Equipment Room - (1) cat5e voice per elevator.
 8. Emergency Phone - (1) cat5e voice.
 9. Buzzcard Cabinet - (2) cat5e data (minimum).
 10. Access Control (RedCloud) – (1) cat5e data (on secure side above door).
 11. Security Digital Recorder - (2) cat5e data.
- G. Workstation connectors for cat5e data and voice shall be 8-pin modular connectors (RJ-45 type).
- H. Workstation connectors for coax CATV video shall be male compression type F-connector. Insert male F-connector into F-type female- female threaded connector in faceplate.
- I. Workstation connectors for 2-strand 50um multimode fiber shall be LC connectors with LC adapter insert.
- J. Data station jacks shall be YELLOW or shall be OFF-WHITE with YELLOW data icon.
- K. Data station jacks for DGMS shall be RED or shall be OFF-WHITE with RED data icon.
- L. Voice station jacks shall be WHITE or shall be OFF-WHITE with WHITE voice icon.
- M. Coax F-connector inserts shall match the color of the faceplate.
- N. Fiber optic inserts shall match the color of the faceplate. The adapter color shall be AQUA for 50um multi-mode fiber and BLUE for single-mode fiber. See Section 274100 for multimedia systems cabling requirements.
- O. All offices will be wired as per these standards so that anyone relocating their office will be able to utilize the standard 10 / 100 / 1000 Base-T to access the network without any additional wiring.

1.18 Data Network Electronics

- A. The data network electronics and associated components (UPS, power strips, fiber optic jumpers, etc...) budget shall be included as a sub line item in the loose equipment budget of the project budget. Data network electronics shall be **funded by the project** and purchased by the Using Agency. A purchase order number shall be supplied to the Using Agency for data network electronics purchase.
- B. All data network equipment should be located in the EF / ER and/or the TRs. Do not allow active equipment to be placed in hidden or ceiling spaces.
- C. The electronics in each TR shall be linked back to the EF / ER via Gigabit ethernet uplink interface over the building fiber backbone. Data network electronics will require (2) two strands of fiber (normally 50/125um multimode) from the building fiber backbone. Data network electronics (thru a combination of 48-port or 24-port blades) shall be able to activate 264 data ports. If TR has over 264 ports to activate, additional data network equipment could be required (w/ associated power / fiber requirements).
- D. Each activated data port shall be 10 / 100 / 1000 Mbps switched ethernet. Provide sufficient data network electronics to activate **ALL** of the installed network ports. Calculate amount data network electronics for every EF / ER and TR to insure proper number of data network electronics, Gigabit interfaces, and fiber jumpers.

1.19 Wireless Network Electronics

- A. The wireless network electronics (APs, power injectors, antennas, etc...) and associated components budget shall be included as a sub line item in the loose equipment budget of the project budget. Wireless network electronics shall be **funded by the project** and purchased by the Using Agency. A purchase order number shall be supplied to the Using Agency for wireless network electronics purchase.
- B. Provide sufficient wireless network electronics to activate **ALL** of the installed Wireless Access Point data ports. Coordinate with Using Agency for wireless network electronic components.

1.20 Telephone Sets and Dial Tone

- A. The telephone sets and dial tone budget shall be included as a sub line item in the loose equipment budget of the project budget. Telephone sets and dial tone shall be **funded by the project** and orders shall be placed by the Using Agency. A purchase order number shall be supplied to the Using Agency for telephone sets and dial tone.
- B. Coordinate with Using Agency's Telecom representative.

1.21 Standards

- A. ANSI/EIA/TIA-568-B.1 Commercial Building Telecommunications Cabling Standard.
- B. ANSI/EIA/TIA-568-B.2 Telecommunications Copper Cabling Systems Standard.
- C. ANSI/EIA/TIA-568-B.3 Telecommunications Optical Fiber Cabling Systems Standard.
- D. ANSI/EIA/TIA-569-A Commercial Building Telecommunications Pathways and Spaces Standard.
- E. ANSI/EIA/TIA J-STD-607-A Commercial Building Grounding and Bonding Requirements for Telecommunications.
- F. ANSI/EIA/TIA-606- An Administration Standard for the Telecommunications Infrastructure of Commercial Buildings.
- G. National Electric Code

1.22 Recommended Reference Materials

- A. Telecommunications Distribution Method Manual (TDMM)
- B. Customer Owned Outside Plant Design Manual

1.23 Specification Sections

- A. The following is a listing of sections of specifications which cover all aspects of networking. The design team is required to utilize these specifications. The specifications will be provided upon request from the Georgia Tech Facilities Engineering in printed and electronic form (Word).
 - 1. Standard Cable Plant Labeling
 - 2. Fiber Optic Cable Labeling
 - 3. Outside Plant Fiber Optic Cable Labeling
 - 4. Voice/Data Wiring Systems
 - 5. Interior Fiber Optic Cable
 - 6. Exterior Fiber Optic Cable
 - 7. Interior CATV Wiring
 - 8. Electronic Card Entry/Control System

END OF SECTION

273013 EMERGENCY PHONES

1.01 General

- A. Reference low voltage design standards at <http://gtlowvoltagestandards.gatech.edu/>

END OF SECTION

274100 MULTIMEDIA INFRASTRUCTURE

1.01 General

- A. Reference low voltage design standards at <http://gtlowvotagestandards.gatech.edu/>

END OF SECTION

274110 DISTANCE LEARNING

1.01 General

- A. Reference low voltage design standards at <http://gtlowvoltagestandards.gatech.edu/>

END OF SECTION

275313 CLOCK SYSTEMS

1.01 General

- A. Synchronized clock systems shall be GPS wireless WiFi type, Primex Wireless or equal.
- B. Synchronized clock shall match the current clocks installed.
- C. Where event signals are to be provided, they shall be integrated with the synchronized clock system.
- D. The original GPS system will remain in use as long as it functions properly. Current GPS clocks may be replaced with either GPS or WiFi clocks, new clocks shall be the WiFi clocks.

END OF SECTION

281300 ACCESS CONTROL

1.01 General

- A. Reference low voltage design standards at <http://gtlowvoltagestandards.gatech.edu/>

END OF SECTION

282300 VIDEO SURVEILLANCE

1.01 General

- A. Reference low voltage design standards at <http://gtlowvoltagestandards.gatech.edu/>

END OF SECTION

283100 FIRE DETECTION AND ALARM

1.01 Scope

- A. Analog-addressable fire alarm systems and components.

2.01 APPLICATION

- A. A local low-voltage addressable fire alarm system shall be included in all new construction and in all major renovations. In smaller projects, extensions of existing systems shall be as appropriate for the type of system existing prior to the work. All fire alarm system work is subject to the approval of the Georgia Tech Fire Marshal. Alterations to existing systems shall include testing of the entire altered portion as well as a representative portion of the remaining system on completion of the work.
- B. Fire alarm systems shall be dedicated to smoke and fire detection, alarm, and related control functions. Do not use fire alarm systems to provide security alarms or other functions.

3.01 Monitoring

- A. All fire alarm systems shall be equipped with compatible digital alarm communicator transmitters using two public telephone system land lines to report alarm and trouble conditions. Setup of monitoring system components shall be coordinated with Facilities.

4.01 Fire Alarm Systems

- A. All campus fire alarm systems must meet the following minimum requirements. Additional functions, features and equipment may be required by code for certain occupancies.
 - 1. Low-voltage addressable analog fire alarm control panel with standby battery power and automatic detector sensitivity testing satisfying the testing requirements of NFPA 72 current edition and 2010 ADA standards for Accessible Design. Fire alarm control panels shall be installed in electrical rooms or other such spaces not generally accessible to the public. The location must be chosen in consideration of the risk of damage to the fire alarm system in the event of fire or failure in other equipment located in the same space. Where programming means are not integral to the fire alarm control panel, furnish one complete set of all cables, equipment and software to the Owner. Furnish backup copies of system software as required by NFPA 72 where applicable.
 - 2. Fire alarm system wiring in residential buildings shall be installed in conduit.
 - 3. Smoke detectors for addressable systems shall be photoelectric type with sensitivities selectable from the FACP (Fire Alarm Control Panel). Heat detectors shall be addressable where available ratings meet the needs of the project. Otherwise, provide appropriately rated heat detectors and addressable monitor modules.
 - 4. Device addresses shall be manually set by means of switches on each device or addressable base or shall be set electronically. Where electronic addressing means is utilized, all equipment and software necessary to program device addresses shall be furnished by the contractor and delivered to the Owner. Rooms required to provide communications features will comply with 2010 ADA Standards and applicable sections of NFPA 72 current edition.

5. All fire alarm systems shall be equipped with a common event reporting digital alarm communicator transmitter compatible with the existing campus monitoring system which supports Silent Knight format 4/2. Provide two telephone lines at each DACT. Program DACTs and establish proper reporting to the campus monitoring system. DACT reporting codes shall be programmed to match those of other campus DACTs. Where programming means is not integral to DACTs, all equipment, cables and software necessary for DACT programming shall be delivered to the Owner.
6. For non-residential buildings, a partial automatic detection system is required consisting of detectors in common areas, lobbies, corridors, stairs, mechanical spaces and normally unoccupied areas. This requirement is in addition to minimum code requirements and applies in sprinklered facilities as well as non-sprinklered facilities. Heat detectors shall be installed in mechanical spaces and other areas in which the expected environment is unsuitable for the proper operation of smoke detectors. 135°F detectors shall be combination fixed temperature and rate-of-rise, addressable type. Higher temperature rated detectors shall be conventional type with rate-of rise sensing except that rate-of-rise sensing shall be omitted where environmental conditions might cause false operation. Conventional detectors shall be grouped in logical zones and monitored by addressable modules. Where detectors are installed, they shall be spaced and installed in accordance with requirements of NFPA 72 for required detectors.
7. For residential buildings, a complete automatic fire detection system including fire detection, alarm and communications and a complete automatic smoke detection system complying with NFPA 72 and providing total coverage is required. This requirement is in addition to minimum code requirements and applies in sprinklered facilities as well as non-sprinklered facilities. Heat detectors shall be installed in mechanical spaces and other areas in which the expected environment is unsuitable for the proper operation of smoke detectors. Where detectors are installed, they shall be spaced and installed in accordance with requirements of NFPA 72 for required detectors. Apartments shall be equipped with at least one system notification appliance, system smoke detectors and a system heat detector in the kitchen area. All residential buildings are to be fully sprinklered and shall include waterflow and tamper switches for fire alarm system alarm and trouble signal initiation.
8. All smoke or heat detectors installed within the building shall be system detectors powered and supervised by the fire alarm control panel.
9. Notification appliances shall be provided throughout and shall be both audible and visual complying with 2010 ADA standards and NFPA 72 current edition. Spacing, locations, intensity and sound levels for all signals shall comply with NFPA 72 requirements. Audible signals shall be ANSI temporal 3. Notification appliances shall be white in color in new installations. In existing building corridors, all appliances per floor shall be the same color.
10. Provide elevator recall for all new and existing elevators in the affected building(s). Designated floors shall be as selected by the Georgia Tech Fire Marshall.
11. Provide smoke detection in air handling systems and fan shutdowns and damper closure in accordance with applicable codes for new and existing air handling systems in the affected building(s).

12. A weatherproof strobe is required on the building exterior near the designated entrance (the entrance nearest the remote annunciator).
13. SLC and NAC circuits shall be designed such that spare capacity is provided. No circuit should be loaded to more than 75% of its capacity. NAC circuit voltage drop as installed shall not exceed 75% of the maximum allowed by the manufacturer at the last appliance on each circuit. Submittals shall include battery and voltage drop calculations, shop drawings and other documentation as needed to demonstrate compliance.
14. A carbon monoxide (CO) monitor system shall be installed where required by the mechanical design requirements. Where a CO monitor system is required, CO monitors shall be equipped with battery backup capable of powering the system for a minimum of 48 hours, telephone lines, and a DACT programmed to report CO alarms to the campus Silent Knight monitoring system. Provide a remote display located outside the mechanical space. CO monitor system control and alarm functions shall be as specified in the mechanical design requirements.
15. Personnel responsible the installation of fire alarm systems shall be licensed as low- voltage or low-voltage alarm contractors and shall have NICET level II certification or factory certification. Personnel responsible for testing and/or maintenance of the fire alarm system shall have NICET Level II certification, factory certification or shall be an employee of a UL listed testing and maintenance organization.
16. Contractor shall provide all software programs and tools for use by Georgia Tech technicians to service the Fire Alarm system.
17. Service and part distribution companies for the Fire Alarm system must be authorized by the Fire Alarm system manufacturer. In addition, these companies must have at least three consecutive years in the Fire Alarm service business. Submit the name and contact information of a local factory-authorized service agency. The service agency must be registered as a vendor with Georgia Tech Business Services. Submit evidence of vendor registration. For information regarding vendor registration, see <http://www.procurement.gatech.edu/vendorinfo.php>

5.01 Remote Annunciator

- A. A remote annunciator shall be provided. Remote annunciators shall consist of an alphanumeric annunciator panel and framed passive graphic display. Provide user-replaceable floor plans behind a clear front panel with a solid backing panel and overall framing system. Floor plans shall show complete floor plans with legible room numbers. See project drawings for additional requirements.
- B. Annunciators shall include an alphanumeric display and associated indicating lamps duplicating the display and indicating lamps at the FACP. Switches shall be provided to permit acknowledging, silencing and resetting functions for alarm, supervisory and trouble signals. The alphanumeric display shall provide English language descriptions of device location, type and status for each alarm, supervisory and trouble event. Access to these switches shall be controlled by a campus standard Best lock. Locks shall be Best 7- pin in accordance with the campus keying system. Key codes for combining by Best will be furnished by the Owner upon request.

- C. Alphanumeric displays and status indicators shall be visible with all doors closed and locked.

5.02 Documentation And Training

- A. For all new systems and all modifications of existing systems, the contractor shall submit a Record of Completion using the form printed in NFPA 72.
- B. The contractor shall furnish all labor, materials and documentation needed to comply with the inspection requirements of the Authority Having Jurisdiction (AHJ).
- C. Measure and report ambient sound levels and fire alarm signal sound levels in representative spaces throughout the facility to prove compliance with NFPA 72 requirements for audibility. Where it is found that additional devices are needed to ensure compliance, provide the necessary devices. Additional devices required to meet this requirement shall not constitute grounds for change-orders. Select locations for sound level measurements in cooperation with the Georgia Tech Fire Marshall. In residence halls and apartment buildings, assume an average ambient sound level of 55dBA and a maximum 60-second sound level of 75dBA except where there is reason to expect higher values or where field measurements indicate higher values.
- D. System documentation shall include a bill of materials, as-built fire alarm system floor plans showing placement of all components, routing of wiring, point addresses, NAC numbers, and wire types and sizes, as-built arrangement of modular components within the fire alarm control panel and numbered terminal strip connections for external wiring connections, point address list and point names for annunciation, battery calculations, copies of the manufacturer's technical literature on all components of the fire alarm system, bound copies of the proper operating procedures for the fire alarm system and procedures for cleaning and maintaining the system, a Record of Completion in accordance with NFPA 72, evidence of installer licensing and certifications, UL and FM approvals and UL listing for system components.
- E. Construction documents shall include plans showing the location of all devices and equipment, riser diagrams, special wiring requirements, and a plan of the remote annunciator.
- F. Furnish a training and familiarization session conducted by the manufacturer's representative for designated Georgia Tech personnel.

END OF SECTION

283300 FUEL-DANGEROUS-GAS DETECTION AND ALARM

1.01 General

- A. The scope of this section is to install the necessary campus standard toxic gas sensors and integrate these requirements into the campus wide Hazardous Dangerous Gas Monitoring and Control System. JCI provides the installation services to Georgia Tech under their Building Automation Controls contract.
- B. The designer may request for a copy of Georgia Tech standard specifications 283300/15722 to include in his project. An example of an existing installation is at the Bunger Henry Bldg.
- C. The project shall furnish plans and specifications to program, install, adjust, calibrate, and make ready for use all sensors, switches, relays, controllers, wiring, and accessories required for a complete and totally functioning DGMCS Monitoring and Control System. Work includes the integration with existing DGMCS systems and testing of the following components:
 - 1. Hazardous (toxic, flammable, explosive corrosive, etc.)
 - 2. Oxygen depletion monitoring.
 - 3. Gas cabinets' shutdown control system.
 - 4. Hazardous alarm notification system.
 - 5. Manual spill alarm push station.
 - 6. Miscellaneous instrumentation as described on the plans.
 - 7. Interface to the building automation system to provide the appropriate actions to ensure the safety of the occupants.
 - 8. Install a touch screen DGMCS terminal next to the building fire alarm graphic annunciate panel in the front lobby/entrance of the building or the location designated for the fire department to respond to the building.
- D. Georgia Tech has selected as a campus wide system the Honeywell Analytics MIDAS sensors and Honeywell Analytics DGMS monitoring server system software. Georgia Tech as established an integrated campus wide DGMS system which consist of a central server located at the Rich Computing Center. This server provides internet access to the authorized personnel to reset alarms and to remotely access the system. Each building will have a Touch Screen monitor in the lobby to allow building occupants access to the DGMS system.
- E. The main components the designers will need to specify is the:
 - 1. Dangerous gas specific sensor installation
 - 2. Valves or interfaces to turn off the supply of the Dangerous substance
 - 3. Interface with the building automation system to purge or evacuate the space.
 - 4. Send a signal to the DGMS server witch will in turn notify by cell phone text messaging the appointed laboratory personnel and the Georgia Tech Environmental Health and Safety officers of the condition. Also the DGMS will notify the Georgia Tech Police via an emergency response digital dialer. The Georgia Tech Police will then contact the Atlanta Hazardous Material unit of the hazardous condition.

5. All sensor alarms shall be hard wired from the sensor to a relay panel to execute the required safety control logic. Sensor alarm controls actions SHALL NOT be transmitted via ethernet unless the DGMS system has a dedicated isolated ethernet system separate from the building and campus network system.
 6. The design documents shall provide a sensor action matrix that identifies each sensor, each alarm level and each action for each device to ensure occupant safety. Each alarm shall secure the dangerous gas at its source, as the dangerous gas enters the lab or work space and secure the tool.
- F. Hazard Evacuation and Notification
1. The intent of this is to produce a complete and functioning Hazard Evacuation Notification (HEN) System.
 2. Equipment to be furnished, installed and wired:
 3. Visual and audio notification devices and complete wiring and conduit work.
 4. It is the intent of this Section that all equipment and devices furnished and installed under this project be properly connected and interfaced with other equipment so as to render the installation complete for successful operation regardless of whether all connections and interfacing.
 5. The equipment installation shop drawings shall be by Georgia Tech Facilities Engineering Office.

END OF SECTION

310000 EARTHWORK

1.01 General:

- A. This section address requirements for earthwork, including clearing, grading, excavation and fill and excavation support and protection related to building construction and infrastructure projects on the Georgia Tech Campus.

2.01 Design Guidelines

- A. Maximum slope for landscape planting and lawn areas is to be 3H:1V (3-feet horizontal to 1- foot vertical).
- B. Landscape planting and lawn areas are to slope away from building at 3% minimum grade for the first ten feet.
- C. Minimum recommended grades:
 - 1. Grassed lawns and swales - 3%
 - 2. Paved gutters and walkways - 1%
 - 3. General Parking Areas - 2%
 - 4. Asphalt paved parking areas and driveways- 2%
 - 5. Concrete paved parking areas and driveways - 1%
- D. Maximum grades for sidewalks, ramps and parking areas shall conform to 28 CFR Part 36, ADA Standards for Accessible Design, Appendix A, ADA Accessibility Guidelines for Buildings and Facilities.
- E. Design is to strive to achieve a balanced cut and fill to minimize the need for haul-in of additional fill material or the need to dispose of excess soil materials.
- F. Design is to strive to minimize the extent of rock removal required for the construction of building foundations and underground utilities.

3.01 Construction Document Requirements:

- A. Construction plans to show existing contours as dashed lines and the proposed contours as solid lines.
- B. Interval for existing grade and finished grade contours to be 1' - 0".
- C. Finish grade at the building shall be 6" (minimum) below the floor line.
- D. Include the following note on grading plans:
 - 1. **Contractor is responsible to contact Georgia Tech Facilities Infrastructure at 404- 385-6000 for information regarding utilities locate request. Submit completed locate request for Georgia Tech owned utilities at least 72 hours prior to any excavation.**
 - 2. Technical specifications are to require the Contractor to submit drawings and supporting calculations for trench support systems for utility trenches 5 feet or more in depth. Submittals for trench support systems shall be prepared, sealed, and signed by a professional civil or structural engineer currently registered in the State of Georgia.
 - 3. For projects that will require blasting for removal of mass rock or trench rock, the technical specifications are to require the Contractor to prepare and submit a comprehensive Blasting Plan and obtain approval before the start of blasting

operations. The Blasting Plan shall identify the proposed methods and procedures for conforming to the State of Georgia Blasting Standards Act, O.C.G.A. 25-8-2, 2009, the State of Georgia Utility Facility Protection Act, O.C.G.A. 25-9-1, and including seismograph monitoring.

1.04 Sustainable Construction

- A. Georgia Tech has the stated objective for the design and construction of all building projects to reduce impacts on the environment surrounding the project site. To the maximum extent feasible and practicable, the grading design shall work with existing topography and shall consider the use of retaining walls to minimize the extent of cut and fill for the project.
1. For projects being developed of previously developed sites restore or protect a minimum of 50% of the site (excluding the building footprint) or 20% of the total site area (including building footprint), whichever is greater, with native or adapted vegetation. Projects may use vegetated roof area in calculation if the plants are native or adapted, provide habitat, and promote biodiversity
 2. For Greenfield sites (site not previously disturbed from their natural state) limit all site disturbance to the following parameters:
 - a. 40 feet beyond the building perimeter or other structures
 - b. 10 feet beyond surface walkways, patios, surface parking and utilities less than 12 inches in diameter
 - c. 15 feet beyond roadway curbs and main utility trenches
 - d. 25 feet beyond constructed areas including stormwater detention infrastructure, sport fields, etc. that require additional staging areas to limit compaction.

END OF SECTION

312500 EROSION AND SEDIMENTATION CONTROLS

1.01 General:

- A. This section addresses requirements for permanent erosion and sediment control and site stabilization.
- B. Design professional is to coordinate permanent site stabilization for erosion control with the site grading plans, the stormwater management plans, and the landscape planting plans.

2.01 Temporary Erosion and Sedimentation Control during Construction

- A. This section addresses requirements for erosion and sediment control during construction.
- B. The design professional and the contractor engaged by Georgia Tech on a project specific basis are to follow the rules and regulations set up by the State of Georgia Environmental Policy Act and enforced by the Georgia Department of Natural Resources Environmental Protection Division and the City of Atlanta.
- C. The City of Atlanta is the local permitting authority having jurisdiction for the issuance and enforcement of Land Disturbance Permits on the Georgia Tech campus. The design professional engaged by Georgia Tech is responsible for obtaining the site construction and storm water management system plan approvals necessary for issuance of a Land Disturbance Permit on a project specific basis.
- D. For project sites of less than one-acre and not requiring a Land Disturbance Permit on any other basis, the construction documents prepared by the design professional are to include erosion and sediment control plans and specifications that indicate the minimum measures to be implemented by the construction contractor to provide erosion and sediment control during construction and for site stabilization at the end of construction.
- E. Design professional is to coordinate preparation of the erosion, sedimentation and pollution control plans with the site grading plans, the storm water management plans, and the landscape planting plans.

3.01 Permitting

- A. The City of Atlanta is the local permitting authority having jurisdiction for the issuance and enforcement of Land Disturbance Permits on the Georgia Tech campus. The design professional is responsible for all permitting coordination with the City of Atlanta including preparing the permit application, submittal of plans and permit applications, addressing review comments, and providing copies of the plans as required for permit issuance on a project specific basis.
- B. The design professional is responsible for preparing the Notice of Intent (NOI) for NPDES Storm Water Permitting, coordinating to obtain the Owner and Operator signatures, and submitting the NOI to the Georgia Environmental Protection Division. These services shall be included in the design professional's scope of services and fee for the Construction Administration phase on a project specific basis.

- C. Per the NPDES permit, a BMP inspection must be conducted by the licensed professional that prepared the Erosion, Sedimentation and Pollution Control Plan (ESPCP) 7-days after initial construction begins. The purpose of the inspection is to ensure that best management practices (BMPs) had been properly installed and maintained, per the approved Erosion, Sedimentation and Pollution Control Plans (ESPCP). These services shall be included in the design professional's scope of services and fee for the Construction Administration phase on a project specific basis.
- D. Georgia Tech may elect to have a representative of Facilities Design and Construction participate in the 7-day inspection. The design professional who conducts the 7-day inspection is to give Georgia Tech's designated project manager at least 24 hours advance notice of the date and time scheduled for the inspection. Advance notice is to be provided by e-mail.

4.01 Qualified Personnel

- A. The construction plans, the contract documents and the technical specifications prepared for the project are to indicate that the construction contractor is to have a certified Worksite Erosion Control inspector with current Level 1A certification on site at all times that construction operations are underway (i.e. during the hours of operation).
- B. The technical specifications are to indicate proof of current certification for the contractor's designated Worksite Erosion Control inspector as a required submittal.

5.01 Permanent Site Stabilization

- A. The design and nature of permanent erosion control features is to be consistent with the landscape design principles defined in the Georgia Tech Landscape Master Plan.
- B. Vegetative materials specified for permanent erosion control are to be consistent with the landscape planting materials identified in the Georgia Tech Landscape Master Plan.
- C. Naturalized spaces to provide stormwater treatment and stormwater velocity controls are preferred over mechanical systems.

6.01 Sustainable Construction

- A. Georgia Tech has the stated objective for the design and construction of all building projects to reduce impacts on the environment surrounding the project. As indicated in Paragraph 1.0 above, for project sites of less than one-acre and not requiring a Land Disturbance Permit on any other basis, the construction documents prepared by the design professional are to include erosion and sediment control plans and specifications as needed to meet the requirements of the Georgia EPD Manual for Erosion and Sediment Control Sixth Edition 2014 and 2003 EPA Construction General Permit or any local standards and codes, whichever is more stringent. The plan must describe erosion and sediment control measures to accomplish these objectives:
1. Prevent loss of soil by storm water runoff and/or wind erosion during construction activities.
 2. Protect topsoil by stockpiling for reuse
 3. Prevent sedimentation of storm sewers or receiving streams.
 4. Prevent pollution of the air with dust and particulate matter.
- B. Placement of erosion and sediment control measures is to be coordinated with the site planning, earthwork and storm drainage design to the maximum extent feasible to conserve existing natural areas and prevent loss of soil by storm water runoff and/or wind erosion during construction activities. Erosion and sediment controls measures must meet or exceed the requirements of the Georgia EPD Manual for Erosion and Sediment Control Sixth Edition 2014 and 2003 EPA Construction General Permit or any local standards and codes, whichever is more stringent.

END OF SECTION

320000 EXTERIOR IMPROVEMENTS

1.01 General:

- A. This section addresses general construction plan requirements for exterior improvements on the Georgia Tech campus.
- B. Construction Documents shall include all required temporary traffic control signage as outlined in the Georgia Tech Temporary Traffic Control Manual posted at www.facilities.gatech.edu/standard-forms.

2.01 Site Plans:

- A. Since all of the systems to support the building come together in the Site Plan, adequate emphasis must be placed on its preparation. It requires careful study, accurate and complete site information, and careful preparation to be clearly understood. The site design impacts a major cost of the project as well as the safety of the users. Liability and maintenance can be greatly minimized with proper site design.
- B. Orient the building on the site to present a good appearance from the street with attention to parking, service access, pedestrian circulation and conforming to all zoning ordinances.
- C. The site plan shall be drawn to a scale of 1 inch equals 20 feet, unless approved otherwise by the Georgia Tech Facilities - Design and Construction Project Manager.
- D. Site Plan shall include the following information at minimum:
 - 1. Sidewalks and sidewalk ramps with dimensions for width, location, longitudinal slope and cross-slope, thickness and material type. Maximum grades for sidewalks and ramps shall conform to 28 FR Part 36, ADA Standards for Accessible Design, Appendix A, ADA Guidelines for Buildings and Facilities.
 - 2. Steps in sidewalks and at building entrances shall have 14-inch treads and 6-inch risers.
 - 3. Maximum grades for sidewalks, ramps and parking areas shall conform to 28 CFR Part 36, ADA Standards for Accessible Design, Appendix A, ADA Accessibility Guidelines for Buildings and Facilities.
 - 4. Curbs and gutters with dimensions for width, location and material type.
 - 5. Survey control points.
 - 6. Boundary surveys for the site including bearings and distances for each property line or lease limit line shown.
 - 7. The location and names of all adjacent streets.
 - 8. Rights-of-ways and easements, for utilities, streets, access, etc.
 - 9. Location and identification of all utilities, including type size and material. See Section 022100 Surveys.
 - 10. Off-street parking in the amount required by the local zoning ordinance, including handicap parking. Provide minimum number of parking spaces required by local code.
 - 11. Notations indicating ingress and egress for vehicular traffic

12. Parking lot layout including parking space markings and pavement markings to define traffic circulation patterns. Indicate pavement type, layout dimensions, and cross-slope. Maximum grades for parking lots and spaces shall conform to 28 CFR Part 36, ADA.
 13. Fences
 14. Traffic signs.
 15. Retaining walls.
 16. Placement of dumpsters and waste receptacles.
 17. All relevant items for property survey.
 18. North arrow, graphical scale and survey legend.
 19. Dimensions of building with appropriate ties to property lines or survey control for construction layout.
 20. Property setbacks of building as required by zoning.
 21. Indicate hardscape materials, coordinated with the landscaping plans.
- E. Provide dimensioned details for all structures on the site, including sidewalks, curbs and gutters, steps, retaining walls, fences, parking stall bumpers, handrails, lighting fixtures, handicapped access ramps, traffic signs, etc. Each detail is to be cross-referenced to the plan location where application of the detail is made.

3.01 Sustainable Construction

- A. Georgia Tech has the stated objective for the design and construction of all building projects to reduce impacts on the environment surrounding the project. To the maximum extent feasible and practicable, the site design shall minimize the disturbance of existing site features and habitat. For green field sites, disturbance limitations are as follows:
1. 40 feet beyond the building perimeter
 2. 10 feet beyond surface walkways, patios, surface parking and utilities less than 12 inches in diameter.
 3. 15 feet beyond primary roadway curbs and main utility branch trenches.
 4. 25 feet beyond constructed areas with permeable surfaces (such as pervious paving areas, storm water detention facilities and playing fields) that require additional staging areas to limit compaction in the constructed area.
- For previously developed areas, a minimum of 50% of the site (excluding the building footprint) or 20% of the total site area (including building footprint), whichever is greater, must be restored or protected with native or adapted vegetation.
- B. Site planning is to include designation for placement of bike racks to provide bicycle storage and for building users. For projects excluding residential, the project design shall provide secure bicycle racks and/or storage within 200 yards of a building entrance for 5% or more of building users measured at peak periods. For residential projects, covered storage facilities for securing bicycles must be provided for 15% or more of the building occupants.

- C. Site planning for parking facilities is to include preferential accommodations for FEV's (fuel efficient vehicle), car pool and van pool. Each new parking facility (deck or surface parking) shall provide a minimum of 3% of the total parking capacity as preferred parking spaces for low-emitting (LEV), fuel-efficient (FEV), and Zero Emission Vehicles (ZEV). In addition, each new parking facility shall provide preferred parking spaces equal to a minimum of 5% of the total parking capacity of car and van pool parking.
1. Low-emitting, fuel-efficient vehicles, and those that are classified as Zero Emission Vehicles (ZEV) by the California Air Resources Board or have achieved a minimum green score of 40 on the American Council for an Energy Efficient Economy (ACEEE) annual vehicle rating guide. Preferred parking spaces are those that are closest to the main entrance of the parking facility (excluding spaces designated for disabled persons).
 2. Signage shall be provided to indication which spaces are LEV, FEV, Car/Van Pool preferred parking spaces within the parking facility.

END OF SECTION

321000 BASES AND PAVING

1.01 General

- A. This section addresses requirements for sub-base courses, aggregate base courses, asphaltic base courses, asphaltic concrete paving and portland cement concrete paving for parking lots, roads, athletic playing surfaces, curbs and gutters, sidewalks and multi-use paths on the Georgia Tech Campus.
- B. Type of surface material to be specified for pavements and sidewalks is to be coordinated with the Georgia Tech Office of Facilities Design and Construction at the Schematic Design Phase.
- C. Materials for athletic playing surfaces and recreational trails are to be consistent with the Georgia Tech Athletic Association Standards and the Georgia Tech Landscape Master Plan. The design professional is to coordinate with the Georgia Tech Office of Facilities Design and Construction for current standards.
- D. Materials for special paving surfaces such as precast concrete pavers, manufactured stone pavers, texturized asphalt or recycled shredded rubber matrix products are to be consistent with the Georgia Tech Landscape Master Plan.

2.01 Base Courses

- A. Aggregate base course is to be provided for all pavements including parking lots, driveways, streets, curbs and gutters, athletic playing surfaces, sidewalks and multi-use paths.
- B. Aggregate base course material is to be clean, crushed graded aggregate produced within not more than 500 miles of the project site, per Paragraph 6.0B below.
- C. Aggregate base course material shall conform to Section 815 of the Georgia DOT Standard Specifications. Material shall meet all requirements of Paragraph 815.2.01 and 815.2.02. Material may be Group 1 or Group 2.
- D. Aggregate source shall be approved by Georgia DOT Office of Materials and Research. Contractor is to be required to provide written documentation of current approval.

3.01 Asphaltic Concrete Pavement

- A. Asphaltic concrete pavement base courses for asphalt paved parking lots, driveways, streets and trails are to be 19mm Superpave per the Georgia Department of Transportation Standard Specifications for Construction of Transportations Systems, current edition.
- B. Asphaltic concrete surface courses for asphalt paved parking lots, driveways, streets and trails are to be 9.5 mm Superpave, Level B per the Georgia Department of Transportation Standard Specifications for Construction of Transportations Systems, current edition.
- C. Asphaltic concrete mixes are to conform to Section 400 of the Georgia DOT Standard Specifications for Construction of Transportations Systems, current edition.
- D. Materials and application of bituminous tack coats are to be in accordance with Section 413 of the Georgia DOT Standard Specifications for Construction of Transportations Systems, current edition.

- E. Materials and application of bituminous prime coats are to be in accordance with Section 412 of the Georgia DOT Standard Specifications for Construction of Transportations Systems, current edition. Bituminous prime coat is to be specified for asphaltic concrete pavement sections with a total combined asphalt thickness of less than 5-inches.
- F. Asphalt plant is to be approved by Georgia DOT Office of Materials and Research. Contractor is to be required to provide written documentation of current approval.
- G. Aggregate material for asphaltic concrete mixes is to be produced within not more than 500 miles of the project site, per Paragraph 6.0B below.
- H. Design professional is to coordinate with the Georgia Tech Office of Facilities Design and Construction for current standard asphalt pavement cross-section applicable to parking lots, driveways, streets and roads.

4.01 Portland Cement Concrete Pavement

- A. Portland cement concrete for concrete paved parking lots, driveways, streets and trails is to be in accordance with Section 500 of the Georgia Department of Transportation Standard Specifications for Construction of Transportations Systems, current edition.
- B. Portland cement concrete for concrete paved parking lots, driveways, streets, sidewalks, trails, and curbs and gutter is to have a minimum 28-day compressive strength of 3,500 psi.
- C. Concrete plant is to be approved by Georgia DOT Office of Materials and Research. Contractor is to be required to provide written documentation of current approval.
- D. Aggregate material for portland cement concrete mixes is to be produced within not more than 500 miles of the project site, per Paragraph 6.0B below.
- E. If attainable, portland cement for portland cement concrete mixes is to be produced within not more than 500 miles of the project site, per Paragraph 6.0B below.
- F. Design professional is to coordinate with the Georgia Tech Office of Facilities Design and Construction for current standard concrete pavement cross-section applicable to parking lots, driveways, streets, roads, and sidewalks.

5.01 Pavement Markings

- A. Pavement markings for the delineation of traffic movements and parking spaces are to be thermoplastic in accordance with Section 653 of the Georgia Department of Transportation Standard Specifications for Construction of Transportations Systems, current edition.
- B. Colors and configuration for pavements markings are to be consistent with the Manual for Uniform Traffic Control Devices and the requirements of Georgia Tech's Office of Auxiliary Services. Design professional is to coordinate with Georgia Tech Office of Facilities Design and Construction to obtain Auxiliary Services current standards.

6.01 Construction Document Requirements

- A. Pavement type and thickness are to be indicated on the Site Plan.
- B. Provide a typical cross-section detail for each type of pavement indicated to be used on the construction plans.

- C. Construction details for special paving surfaces such as precast concrete, manufactured stone pavers, texturized asphalt or recycled shredded rubber matrix products are to be consistent with the Georgia Tech Landscape Master Plan.

6.02 Sustainable Construction

- A. Georgia Tech has the stated objective for the design and construction of all building projects to reduce impacts on the environment surrounding the project. To the maximum extent feasible and practicable, the site design shall consider the use of concrete pavement for new parking lots and driveways to minimize heat island effects. This includes a strong preference for projects requiring asphalt paving to consider use of surface treatments that increase the pavement solar reflectance index (SRI) to 29 or above to assist with reducing heat island effect. For more information see Caltrans Division of Research and Innovation “Cool Pavements Research and Technology” report dated September 1, 2011. Also see Micro Overlay product named E-Krete™ manufactured by PolyCon of Madison, Mississippi.
- B. To the maximum extent feasible and practicable, the construction bid documents are to specify that no less than 50% of materials (in terms of materials and products cost) for pavement construction be harvested, extracted, or manufactured in the State of Georgia. It is Georgia Techs strong preference to begin with the closest local (Atlanta Metropolitan Area) region first, and then move outward within the state, and finally up to the 500 mile region beyond.
- C. Stone, asphalt and concrete waste materials resulting from the demolition of existing pavements are to be salvaged for recycling or re-use. These materials are to be referenced in the construction waste management plan required for the project as delineated in section 017419 4.01 A of the Yellow Book.
- D. Portland cement concrete specified for parking lots, driveways and sidewalks is be reinforced with synthetic fibers in lieu of welded wire fabric or steel reinforcing bars wherever possible to maximize potential for recycling of concrete waste materials in the future.
- E. The use of porous concrete pavement and other porous paving materials including porous paver systems is to be considered for parking lots, driveways, sidewalks and trails to minimize storm water runoff.
 - 1. Sites with Imperviousness \leq 50% implement a stormwater management plan that prevents the post-development peak discharge rate and quantity from exceeding the predevelopment peak discharge rate and quantity for 2-year 24-hour design storm. Or Implement a stormwater management plan that protects receiving stream channels from excessive erosion in accordance with Georgia EPD Manual for Erosion and Sediment Control Sixth Edition 2014. The stormwater management plan must include stream channel protection and quantity control strategies.
 - 2. Sites with Imperviousness $>$ 50% implement a stormwater management plan that results in a 25% decrease in the volume of stormwater runoff from the 2-year 24-hour design storm.

END OF SECTION

323100 FENCES AND GATES

1.01 General

- A. This section addresses requirements for permanent and temporary fences and gates.
- B. It is recognized that the need for fencing for pedestrian and vehicular safety and for security is unavoidable on the Georgia Tech campus. As much as possible, the fence placement and the selection of fence materials and colors should result in a fence that blends in to be an integral part of the campus landscape.
- C. Chain link fencing is to be used for temporary construction fencing including tree protection fencing, and for permanent security fencing for mechanical yards, utility installations, etc.
- D. Architectural metal fencing and gates shall be consistent with the Georgia Tech Landscape Master Plan, incorporated here by reference.

2.01 Fence Materials

- A. Chain link fencing for temporary construction fencing including temporary tree protection is to be 9 gage galvanized steel wire, 2-inch mesh.
- B. Chain link fencing for permanent security fencing is to be 9-gage galvanized steel wire, 2-inch mesh, vinyl-coated. Vinyl coating color is to be approved by the Georgia Tech Office of Facilities Design and Construction.
- C. Materials and colors for architectural metal fencing and gates shall be consistent with the Georgia Tech Landscape Master Plan, incorporated herein by reference.
- D. The height of fences is to be determined on a site specific case by case basis.
- E. Security bollards are to be provided on an as needed basis to protect buildings, utility structures, and utility appurtenances from damage by vehicular traffic at loading docks, service entrances, mechanical room, etc.
- F. Removable bollards shall be consistent with the Georgia Tech Landscape Master Plan.

3.01 Sustainable Construction

- A. Georgia Tech has the stated objective for the design and construction of all building projects to reduce impacts on the environment surrounding the project. Waste materials resulting from the demolition of existing fencing is to be salvaged for recycling or re-use as part of the required construction waste management plan for the project. Salvaged or recycled fencing will contribute to the required percentage of recycled construction and demolition materials for the project, which is defined on a project-by-project basis.
- B. To the maximum extent feasible and practicable, the construction bid documents are to specify that no less than 10% of materials (in terms of materials and products cost) for fence construction be harvested, extracted, or manufactured in the State of Georgia. It is Georgia Techs strong preference to begin with the closest local (Atlanta Metropolitan Area) region first, and then move outward within the state, and finally up to the 500 mile region beyond.

END OF SECTION

323200 RETAINING WALLS

1.01 General

- A. This section addresses requirements for site retaining walls that are not part of or attached to a building structure.

2.01 Structural Design Standards

- A. Structural design calculations are required for all retaining walls more than 3 feet in height. Structural design shall be performed by a registered professional engineer.
- B. Soils parameters used in design of retaining walls shall be based on site specific geotechnical data provided in subsurface investigation report as prepared by a registered professional engineer or professional geologist. The use of assumed soil parameters for design of retaining walls is not acceptable.

3.01 Retaining Wall Material Requirements

- A. Retaining walls are to be constructed of granite or of concrete with brick veneer with precast concrete caps conforming to the Georgia Tech Landscape Master Plan, incorporated herein by reference.
- B. Retaining walls are to be constructed with vertical drainage system behind the wall with an outlet pipe connected to the storm drainage system, or with a direct outlet to a drainage channel. Weep holes as a means of drainage for retaining wall systems are not to be used except as specifically approved by Georgia Tech's Office of Facilities Design and Construction.
- C. Drainage pipes that discharge directly to a drainage channel are to be protected by a headwall and are to be supplied with a TideFlex or similar type valve to prevent surcharging of the pipe during highwater conditions.
- D. A built-in place mockup of retaining wall is to be provided by the construction contractor and approved by the Georgia Tech Office of Facilities Design and Construction in advance of wall construction.

4.01 Sustainable Construction

- A. Georgia Tech has the stated objective for the design and construction of all building projects to reduce impact of the project on the surrounding environment. To the maximum extent feasible and practicable, the site design shall consider the use of retaining walls to minimize disturbed areas. For green field sites, disturbance limitations are as follows:
 - 1. 40 feet beyond the building perimeter
 - 2. 10 feet beyond surface walkways, patios, surface parking and utilities less than 12 inches in diameter.
 - 3. 15 feet beyond primary roadway curbs and main utility branch trenches.
 - 4. 25 feet beyond constructed areas with permeable surfaces (such as pervious paving areas, storm water detention facilities and playing fields) that require additional staging areas to limit compaction in the constructed area.

- For previously developed areas, a minimum of 50% of the site (excluding the building footprint) or 20% of the total site area (including building footprint), whichever is greater, must be restored or protected with native or adapted vegetation.
- B. To the maximum extent feasible and practicable, the construction bid documents are to specify that no less than 10% of materials (in terms of materials and products cost) for retaining wall construction be harvested, extracted, or manufactured in the State of Georgia. It is Georgia Techs strong preference to begin with the closest local (Atlanta Metropolitan Area) region first, and then move outward within the state, and finally up to the 500 mile region beyond.
 - C. Brick, stone and concrete waste materials resulting from the demolition of existing retaining walls is to be salvaged for recycling or re-use as part of the required construction waste management plan for the project. Salvaged or recycled fencing will contribute to the required percentage of recycled construction and demolition materials for the project, which is defined on a project-by-project basis.

END OF SECTION

331000 WATER UTILITIES

1.01 General:

- A. This section addresses requirements for water utilities on the Georgia Institute of Technology (GT) Campus including water mains for domestic service and fire protection, valves, fire hydrants and other appurtenances.

2.01 Design Guidelines

- A. Water Distribution for Domestic Service and Fire Protection:
 - 1. All water distribution main materials including piping, valves, fire hydrants and vaults for water system appurtenances shall be as approved by the City of Atlanta Department of Watershed Management, Technical Services Division and all applicable codes including the Georgia Department of Natural Resources Environmental Protection Division Minimum Standards for Water Systems, current edition.
 - 2. Piping for domestic service and fire protection service lines to be maintained by Georgia Tech shall be as follows:
 - 3. Piping 3-inch diameter and larger is to be ductile iron pipe in accordance with AWWA C151, cement lined as per AWWA C104, coated inside and outside with an approved coal-tar coating. Pipe to be Pressure Class 350 minimum, with push-on or mechanical joints in accordance with AWWA Standard C111. Ductile iron pipe and fittings to be by American or U.S. Pipe only.
 - a. Piping less than 3-inches in diameter is to be ASTM D2241 pressure rated PVC pipe, SDR 21 minimum, with solvent weld joints.
 - 4. Coordinate water service piping size requirements for domestic service and for fire protection with the plumbing plans.
 - 5. Provide backflow prevention devices as required by the City of Atlanta Department of Watershed Management, Technical Services Division and all applicable codes.
 - 6. Pressure and leakage tests shall be performed in accordance with the latest edition of AWWA Standard C600 and the Georgia Department of Natural Resources Environmental Protection Division Minimum Standards for Water Systems, current edition.
 - 7. New water mains shall be disinfected before they are placed in service. Disinfection of new mains and services including the disposal of the heavily chlorinated water following the disinfection is to be accomplished in accordance with the latest edition of AWWA Standard C651 and Georgia Department of Natural Resources Environmental Protection Division Minimum Standards for Water Systems, current edition.
 - 8. Water system design is to provide flush, wall-mounted hose bibs minimum on each side of building. Where length of building wall exceeds 200 feet, provide additional hose bibs at spacing not exceeding 200 feet on center.
- B. Landscape Irrigation Systems:
 - 1. Provide a 2-inch diameter water line stub-out at 2 feet below finished grade, and at 2 feet outside of building facade near service area in a landscape area for irrigation use.

2. Coordinate with the electrical design to provide a 120 volt electrical power supply stubout to outside wall in service area at 5-feet above ground level for irrigation controller.
3. Coordinate irrigation system design with landscape design. Irrigation controller to be Calsense ET20008. Manufacturer's representative contact number is 1-800-572-8608.
4. Irrigation system water supply shall be protected by an above ground RPZ backflow preventer as approved by the City of Atlanta Department of Watershed Management, Technical Services Division and shall comply with all codes in the state of Georgia.
5. Backflow preventer for irrigation system water supply to be installed in a concrete composite utility box with decorative pattern and coloring. Coordinate with Facilities Engineering for typical detail and color specifications. See www.hot-box.com.

3.01 Construction Document Requirements

- A. Utility plans are to be at the same scale as the building site plans. For standalone utility plans not associated with a new building or building renovation project, the utility plans are to be at the same scale as the survey.
- B. Utility plans are to show existing and proposed water mains, services and appurtenances.
- C. Show all existing and proposed easements.
- D. Provide construction details on the construction plans, including current applicable City of Atlanta standard details.
- E. Include the following note on utility plans:
- F. Contractor is responsible to contact Georgia Tech Facilities Infrastructure at 404-385-6000 for information regarding utilities locate request for Georgia Tech owned utilities. Submit completed locate request for Georgia Tech owned utilities at least 72 hours prior to any excavation.
- G. Technical specifications applicable to water utility construction are to require the Contractor to submit drawings and supporting calculations for trench support systems for utility trenches 5 feet or more in depth. Submittals for trench support systems shall be prepared, sealed, and signed by a professional civil or structural engineer currently registered in the State of Georgia.
- H. For projects that will require blasting for removal of trench rock for water utility construction, the technical specifications are to require the Contractor to prepare and submit a comprehensive Blasting Plan and obtain approval before the start of blasting operations. The Blasting Plan shall identify the proposed methods and procedures for conforming to the State of Georgia Blasting Standards Act, O.C.G.A. 25-8-2, 2009, the State of Georgia Utility Facility Protection Act, O.C.G.A. 25-9-1, and including seismograph monitoring.

3.02 Sustainable Design and Construction

- A. The Governor’s Water Conservation Challenge commits all state agencies and authorities in Georgia to implement practices that help reduce water usage by a minimum of 2% annually through the year 2020. Reductions will be calculated on a per square foot basis, using fiscal year 2007 as the baseline.
- B. GT is moving toward capturing 90% of all stormwater generated on campus and some black water from selected buildings. The water collected and processed through Georgia Tech infrastructure may be available to provide water for water closet and urinal flushing and landscape irrigation. The design team is responsible to determine if non-potable and or grey water if available from GT is available and utilize GT infrastructure, if available, to offset City water, stormwater, and sewer services.
- C. Georgia Tech has the stated objective for the design and construction of all building projects to meet or exceed The Governor’s Water Conservation Challenge. Design of irrigation systems are to minimize the use of potable water or natural water resources in accordance with Yellow Book 010001 to maximize water efficiency. Irrigation system design should consider use of captured rainwater and use of recycled wastewater as a means of reducing or eliminating potable water use for irrigation.

END OF SECTION

333000 SANITARY SEWERAGE UTILITIES

1.01 General

- A. This section addresses requirements for sanitary sewerage utilities on the Georgia Institute of Technology (GT) Campus including sanitary sewer mains and services.

2.01 Design Guidelines

- A. All sanitary sewer main materials including piping and manholes shall be as approved by the City of Atlanta Department of Watershed Management, Technical Services Division and all applicable codes.
- B. Piping for sanitary sewer mains and service lines to be maintained by GT shall be ductile iron. Ductile iron pipe is to be in accordance with AWWA C151, cement lined as per AWWA C104, and coated inside and outside with an approved coal-tar coating. Pipe to be Pressure Class 350 minimum, with push-on joints in accordance with AWWA Standard C111. Ductile iron pipe and fittings to be by American or U.S. Pipe only.
- C. Coordinate sanitary sewer service line size and location requirements with the plumbing plans.
- D. All gravity sewer mains and service pipe lines will be subject to tests for leakage made in the presence of the Owner. Allowable leakage into or out of the system through the sewers, laterals and manholes, is not to exceed 100 gallons per 24 hours per mile of pipe per inch of diameter except that where exfiltration tests are required or necessary, the joints shall perform equally well, but are permitted for each additional 2 foot head over basic 2 foot minimum internal head. Low pressure air testing may be provided as an alternate to hydrostatic testing for infiltration and exfiltration if approved by the City of Atlanta Department of Watershed Management, Technical Services Division and/or Georgia Tech.

3.01 Construction Document Requirements

- A. Construction plans for sanitary sewer mains and services are to provide the following at minimum:
 - 1. Plan and profile for proposed sewers.
 - 2. Construction details for manholes and any special sewer structures, including current applicable City of Atlanta standard details.
 - 3. All existing and proposed easements.
- B. Utility plans are to be at the same scale as the building site plans. For standalone utility plans not associated with a new building or building renovation project, the utility plans are to be at the same scale as the survey. Horizontal scale for sanitary sewer profiles shall match the plan scale. Vertical scale for sanitary sewer profiles shall be 1 inch equals 5 feet where the horizontal plan scale is 1 inch equals 20 feet or 1 inch equals 10 feet. Vertical scale for sanitary sewer profiles shall be 1 inch equals 10 feet where the horizontal plan scale is 1 inch equals 30 feet or greater.

- C. Include the following note on utility plans:
1. **Contractor is responsible to contact Georgia Tech Facilities Infrastructure at 404/ 385-6000 for information regarding utilities locate request for Georgia Tech owned utilities. Submit completed locate request for Georgia Tech owned utilities at least 72 hours prior to any excavation.**
 2. Technical specifications applicable to sanitary sewerage utilities construction are to require the Contractor to submit drawings and supporting calculations for trench support systems for utility trenches 5 feet or more in depth. Submittals for trench support systems shall be prepared, sealed, and signed by a professional civil or structural engineer currently registered in the State of Georgia.
 3. For projects that will require blasting for removal of trench rock for sanitary sewerage utility construction, the technical specifications are to require the Contractor to prepare and submit a comprehensive Blasting Plan and obtain approval before the start of blasting operations. The Blasting Plan shall identify the proposed methods and procedures for conforming to the State of Georgia Blasting Standards Act, O.C.G.A. 25-8-2, 2009, the State of Georgia Utility Facility Protection Act, O.C.G.A. 25-9-1, and including seismograph monitoring.

4.01 Sustainable Design and Construction

- A. The Governor's Water Conservation Challenge commits all state agencies and authorities in Georgia to implement practices that help reduce water usage by a minimum of 2% annually through the year 2020. Reductions will be calculated on a per square foot basis, using fiscal year 2007 as the baseline.
- B. Georgia Tech is moving toward capturing 90% of all stormwater generated on campus and some black water from selected buildings. The water collected and processed through Georgia Tech infrastructure may be available to provide water for water closet and urinal flushing and landscape irrigation. The design team is responsible to determine if non-potable and or grey water if available from GT is available and utilize GT infrastructure, if available, to offset City water, stormwater, and sewer services.

END OF SECTION

334000 STORM DRAINAGE UTILITIES

1.01 General

- A. This section addresses requirements for storm drainage utilities on the Georgia Tech Campus including storm water collection, conveyance, treatment and detention systems.

2.01 Design Guidelines

- A. Design of stormwater systems is to meet the minimum requirements of the State of Georgia Stormwater Management Manual (Blue Book), the City of Atlanta Stormwater Management Program, and is to be consistent with Georgia Tech's **Stormwater Management Objectives**:
 1. Develop the Eco-Commons and associated Corridors into a sustainable stormwater management system.
 1. Reconstruct and condition soils to increase infiltration and storage.
 2. Recharge groundwater supplies and reinvigorate pre-existing natural drainage systems of the campus.
 3. Increase campus tree canopy coverage.
 4. Increase the campus coverage of woodlands.
 5. Manage storm-water as close to its point of contact as possible.
 6. Replace existing management systems which funnel storm-water into pipes, with systems that bring water into contact with the soil.
 7. Treat stormwater as a valuable resource, including harvesting it for non-potable uses.
 8. Utilize campus corridors as multi-purpose avenues, with ecological function that include detention, infiltration, recharge and conveyance of water to the Eco- Commons.
- B. Stormwater management design is to be documented in a Stormwater Management System Design Report as is required for compliance with the City of Atlanta Stormwater Management Program.
- C. Design of stormwater systems is to be coordinated with the design of temporary and permanent erosion control measures.
- D. Materials for storm drainage systems including pipe, manholes, catch basins, curb inlets, culverts, headwalls and iron castings are to be approved by the City of Atlanta Department of Watershed Management, Technical Services Division and/or Georgia Tech.
- E. All solid wall storm drain pipe is to be furnished with gasketed leak proof joints.

3.01 Construction Document Requirements

- A. Grading and drainage plans are to show existing contours as dashed lines and proposed contours as solid lines at 1-foot intervals.
- B. See Section 310000 Earthwork for grading design guidelines.

- C. Complete plans and details are to be provided for all stormwater system components including the following:
 - 1. Plan and profiles for proposed storm drain lines. Profiles are to show invert elevations and slopes for all culverts, pipes and structures.
 - 2. Construction details for manholes and any special sewer structures, including current applicable City of Atlanta or Georgia Department of Transportation standard details.
 - 3. All existing and proposed easements required for construction and maintenance of storm drainage facilities.
 - 4. Detailed dimensions, elevations, and volumes for all underground stormwater detention, retention and treatment structures.
 - 5. Size and location of rain gutter and downspout discharges, including connections to the drainage system.
- D. As a general rule, do not connect downspouts directly into the drainage system, except as may be necessary for pedestrian safety.
- E. Storm drainage and grading plans are to be at the same scale as the building site plans. Horizontal scale for storm drain profiles shall match the plan scale. Vertical scale for storm drain profiles shall be 1 inch equals 5 feet where the horizontal plan scale is 1 inch equals 20 feet or 1 inch equals 10 feet. Vertical scale for storm drain profiles shall be 1 inch equals 10 feet where the horizontal plan scale is 1 inch equals 30 feet or greater.
- F. Include the following note on storm drainage and grading plans:
- G. Contractor is responsible to contact Georgia Tech Facilities Infrastructure at 404-385-6000 for information regarding utilities locate request for Georgia Tech owned utilities. Submit completed locate request for Georgia Tech owned utilities at least 72 hours prior to any excavation.
- H. Technical specifications applicable to storm drainage utilities construction are to require the Contractor to submit drawings and supporting calculations for trench support systems for utility trenches 5 feet or more in depth. Submittals for trench support systems shall be prepared, sealed, and signed by a professional civil or structural engineer currently registered in the State of Georgia.
- I. For projects that will require blasting for removal of trench rock for storm drainage utility construction, the technical specifications are to require the Contractor to prepare and submit a comprehensive Blasting Plan and obtain approval before the start of blasting operations. The Blasting Plan shall identify the proposed methods and procedures for conforming to the State of Georgia Blasting Standards Act, O.C.G.A. 25-8-2, 2009, the State of Georgia Utility Facility Protection Act, O.C.G.A. 25-9-1, and including seismograph monitoring.

4.01 Sustainable Site

- A. Georgia Tech has the stated objective for the design and construction of all building projects to be examples in sustainable design and construction and attain or be capable of attaining Peach Green Building Rating System point level of 31 points in addition to Yellow Book Requirements. To the maximum extent feasible and practicable, the storm drainage and grading design shall consider the use of retaining walls to minimize the extent of cut and fill slopes in accordance with Yellow Book Sections 323200 Retaining Walls and 310000 Earthwork, to minimize disturbed areas and Protect or Restore Habitat, defined in the Yellow Book.
- B. The placement of stormwater management facilities is to be coordinated with the site planning, earthwork and erosion control design in compliance with Yellow Book Section 310000 Earthwork.
- C. To the maximum extent feasible and practicable, the construction bid documents are to specify that materials for storm drainage utilities be Georgia-based Materials & Products and documented in accordance with Yellow Book Section 010001 General Requirements and Peach Green Building Rating System
- D. Metal pipe, stone, asphalt and concrete waste materials resulting from the demolition of existing storm drainage utilities are to be salvaged for recycling or re-use to maximize the potential in accordance with Yellow Book 017419 Construction Waste Management for recycling a minimum of 85% Construction Waste Management.
- E. Portland cement concrete specified for ditch paving and gutters is to be reinforced with synthetic fibers in lieu of welded wire fabric or steel reinforcing bars wherever possible to maximize potential for recycling of concrete waste materials in the future.
- F. The stormwater management design is to implement the use of porous concrete pavement and other porous paving materials including porous paver systems for parking lots, driveways, sidewalks and trails to minimize stormwater runoff and achieve Section 312500 Erosion and Sedimentation Controls. Materials for pervious or porous pavement systems utilizing precast concrete pavers, manufactured stone pavers, texturized asphalt or recycled shredded rubber matrix products are to be consistent with the Georgia Tech Landscape Master Plan.

The design of storm drainage systems and development of the overall stormwater management plan is to minimize the use of impervious materials, promote infiltration, and provide stormwater quality controls consistent with the State of Georgia Stormwater Management Manual (Blue Book) to achieve Section 312500.

END OF SECTION

339000 CISTERNS

1.01 General

- A. In support of Georgia Tech's commitment to sustainability and water conservation, Georgia Tech promotes the use of cisterns for rainwater and HVAC condensate harvesting for use in irrigating the campus and to provide water for flushing water closets and urinals. Development of a new cistern system shall be coordinated through CPSM and shall be in conformance with the Campus Storm Water Management Master plan.
- B. Where harvested water is used for water closet and urinal flushing, only roof rainwater and HVAC condensate may be used. Cisterns capturing site runoff may only be used for irrigation.
- C. Metering of cistern usage shall be in accordance with campus standards and interface with the campus ION system. Measurements shall be for total water consumption and be read in 100gal per contact closure increments. Separate metering shall be provided for irrigation and flushing systems.
- D. Installation of harvested water systems shall be in compliance with the current International Plumbing code and all GA amendments. As this continues to be a developing application, it is important that the design engineer is current with all applicable codes.
- E. All systems supplied by the cistern shall be equipped with an automated domestic water back-up system. If the back-up system is provided at the cistern, a low level indicating device shall be provided such that only one day's worth of water is filled at the cistern in order to maximize rainwater harvesting and minimize overflow to drain. As an alternate, a separate day tank may be provided for such back-up. An approved air gap shall be provided at the point of connection as required by code to provide backsiphonage and backpressure protection to the city system.
- F. Cistern pumps shall be controlled OFF based on a low level indicating device.
- G. The campus controls vendor (Johnson Controls) shall provide feedback of the cistern pump status and automated valve positions through the campus controls front end (Metasys).
- H. For cisterns over 10,000gal, provide an ultrasonic or laser level device that will provide cistern level information to be reported to the campus controls front end. This information may also be integrated into a building energy dashboard.
- I. Cisterns shall be installed with a treatment and filtration system that at a minimum meets the International Plumbing code with GA amendments. Cisterns serving irrigation systems with spray and rotor heads shall be filtered to 300microns or below. Drip irrigation and water closet/urinal flushing systems shall be filtered to a minimum of 100 microns.
- J. Large concrete cisterns shall utilize a sump and submersible pump configuration.

END OF SECTION



The End...